

HAWORTH

Accessories

North America Price List – February 2024



Electronic Update Page – Accessories Price List

- The table below lists all of the updates and addendums added to this price list since the original version was created.
- All **Update** pages will replace the existing pages within the document.
- All **New** pages will be placed at the back of the document.

Link	Date	Pages	Description
Click Here	February 2024	206	Update – Round Peg Magnets have been obsoleted.
Click Here	March 2024	1A	New – Belong Power 65W Price List page added.
Click Here	March 2024	3A-4A	New – Belong Hatch Price Page added.
Click Here	March 2024	207	Update – Note added to DS-3 that attachment hardware is included and that it is on GSA contract
Click Here	May 2024	117, 118, 126, 147, 156	Update – Various Ergotron product obsoletions added to the Price List Pages.
Click Here	May 2024	157	Update – WQAG-0303 Class changed PT to IN.
Click Here	May 2024	181	Update – Correct catalog number for the Personal Storage Hook
Click Here	May 2024	187	Update – AKWN-1230-EUN – added Flint PET-C1.
Click Here	May 2024	207	Update – DS-3 – Updated to reflect on GSA contract and added feature indicating what is included.



This Haworth North American price book contains US list prices.

Canadian customers can convert the US list price into their Canadian equivalent by going to www.Haworth.com/Canada to find the current Canadian multipliers. These multiplier factors allow you to convert the US list price into a Canadian list price.

Haworth Price List Overview

Tips for Using Haworth Price Books

The following overview explains how information is organized within the Accessories price book (includes Ergotron®, Planes®, Reed Premier™, Brazo®, LIM®, Pip™, Planes®, PREMISE®, UniGroup®, Compose®, Belong™ and PLACES®).

Navigation Links

Use the links to jump back and forth to relevant pages.

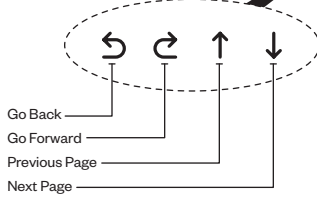

Modular Lower Storage
2H Slim Pedestal - Attached

Personal Drawer/Open

Features

- Available in 18" and 24" depth pedestal and pedestal with pedestal, with mounting glides with T-LOCK™ adjustment cap.
- Available in 18" and 24" depth pedestal and pedestal with pedestal, with mounting glides with T-LOCK™ adjustment cap.
- Top is provided for pedestal configuration or as part of pedestal configuration.
- Drawer slides are heavy duty.
- Drawer has 22" adjuster for pedestal loading slides.
- Drawer comes with heavy duty.
- Available for use in the following:
- Available for use in the following:
- Available for use in the following:

Specification Tips

For full options, refer to Link Program section of the Accessories Price List.

To Order, Specify:

- Link Option
- Link Option
- Link Option
- Link Option
- Link Option
- Link Option

Height	Depth	Width	Number	Case Grade A Front Grade		Case Grade B Front Grade	
				A	B	A	B
24" (610mm)	18" (457mm)	18" (457mm)	10	885.00	825.00	825.00	765.00
24" (610mm)	18" (457mm)	24" (610mm)	10	985.00	925.00	925.00	865.00
24" (610mm)	24" (610mm)	18" (457mm)	10	1085.00	1025.00	1025.00	965.00
24" (610mm)	24" (610mm)	24" (610mm)	10	1185.00	1125.00	1125.00	1065.00

Haworth Price Books are organized into the following sections:

Price List Section

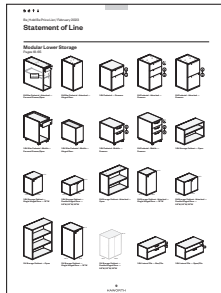

Statement of Line
Provides a visual overview of the product offering.

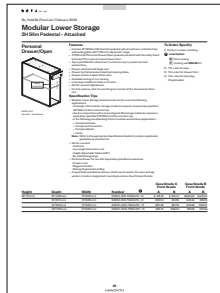

Price List
Includes product features, specification tips, catalog numbers and list pricing.

Resources Section

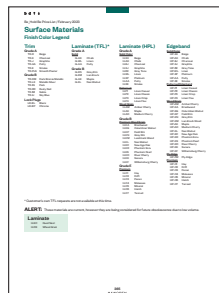

Finishes and Fabrics
Lists available product finishes and fabrics.

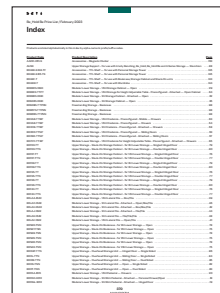

Index
Lists products alphabetically by catalog number.



Warranty and Terms of Sale
Provides warranty information and general terms.

Table of Contents

Statement of Line	7-20
Electrical Components	
Power Cube	21
Plug Strip	21
Power Suite	21
Wire Management Tray General Specifications	
Wire Management Tray	22
Electrical Components	
Wire Management Tray	23
Belong Power Cube 65W and Belong Power Suite 65W	24
Cord Management Cuff	25
Mesh Cord Manager with Cuffs	25
Power Tap — Horizontal	26
Power Tap — Vertical	27
Power Tap — Hardwire	28
Power Tap — Corded Horizontal and Vertical	28
Power Tap Bracket — Fixed	29
Power Tap Bracket — Adjustable	29
Power Tap Bracket — Under Surface	30
Power Tap Bracket with Grommet	30
Bezel Utility Module	31
Data Bezel	31
Cables	32
Retrofit USB Charging Cable	32
Classic Power Module	33
Classic Power Module Bracket - Angled	34
Classic Power Module Bracket - Vertical Bracket	34
Classic Power Module Bracket - Under Surface	34
Collaborative Power Station	35
Enhanced Power Module — Seamless	37
Enhanced Power Module — Corded	41
Enhanced Power Module — Hardwire	47
Enhanced Power Module — Spiral Corded — Height Adjustable	52
Enhanced Power Module — Cord for Height Adjustable	53
Above Worksurface – Adjustable	54
Above Worksurface – Adjustable with Tackboard Offset	55
Above Worksurface – Fixed	55
Under Worksurface – Fixed	55
For Use with X Series	56
Power, Data and USB	57
Flip Top Unit with Smooth Bezel — Corded — Double-Sided — Power, Data and USB	61
Flip Top Unit with Smooth Bezel — Hardwire — Single-Sided — Power, Data and USB	65
Flip Top Unit with Smooth Bezel — Hardwire — Double-Sided — Power, Data and USB	69
Flip Top Units — Power and Data	73
Flip Top Unit — Non-Powered	74
Flip Top Unit – Corded – Single-Sided — Power, Data and USB	75
Flip Top Unit — Corded — Double-Sided — Power, Data and USB	81
Flip Top Unit — Hardwire — Single-Sided — Power, Data and USB	87
Flip Top Unit — Hardwire — Double-Sided — Power, Data and USB	93
Flush Mounted Power — Corded	99
Flush Mounted Power — Hardwire	103
Flush Mounted Power — Spiral Cord for Height Adjustable	107
Flush Mounted Power — Cord for Height Adjustable	111
Flush Mounted — Round	114
Wireless Charging Module	115

Ergotron Keyboard Tray

Keyboard Tray with Mouse Pad	116
Neo-Flex Keyboard Tray	116

Ergotron CPU Holder

Small CPU Holder	117
Universal CPU Holder	117
Cable CPU Holder	117

Ergotron Monitor Arms and Accessories

Single Arm	118
Dual Arm	118
HX Triple Monitor Bow Kit	119
LX Desk Mount	120
Single Arm	120
Dual Arm	120
LX Monitor Arm — Tall Pole	121
LX Dual Stacking Arm - Tall Pole Monitor Arm	121
LX Sit-to-Stand Mount	122
Single Arm	122
LX Desk Dual Direct	123
Dual Direct Arm	123
Dual Direct Handle Kit	123
LX One-Stop Rotational Control Kit	124
LX Two-Stop Rotational Control Kit	124
LX Extension	125
LX Sit-to-Stand Extension	125
LX Pole Collar	125
LX Arm, Extension and Collar Kit	125
MXV Desk Mount	126
Single Arm	126
Dual Arm	126
MX	127
Desk Mount - Single Arm	127
Wall Mount - Heavy Duty	127
Dual Monitor and Handle Kit	128
Monitor Quick Release LCD Bracket	128
Grommet Mount for LX Single and Dual Direct Arms	129
Grommet Mount for LX Dual Arm	129
Grommet Mount for LX Arm on WorkFit-T/TL	129
Grommet Mount for MXV Single Monitor Arm	129
Grommet Mount for MXV Dual Monitor Arm	129
Top Mount Low Profile C-Clamp	130

Ergotron Monitor Mount and Accessories

Single Monitor	131
Dual Monitor	132
Single Conversion Kit	133
Dual Conversion Kit	133

Ergotron WorkFit and Accessories

Ergotron WorkFit-A — Single Attached Sit-Stand Workstation ..	134
Ergotron WorkFit-A — Dual Attached Sit-Stand Workstation ..	135
Ergotron WorkFit-C — Single Monitor	136
Ergotron WorkFit Corner — Standing Desk Converter	137
Ergotron WorkFit-LX — Sit-Stand Desk Mount System	138
Ergotron WorkFit-S — Single Attached Sit-Stand Workstation ..	139
Ergotron WorkFit-S — Dual Attached Sit-Stand Workstation ..	140
Ergotron WorkFit-SR — Dual Attached Sit-Stand Workstation ..	141
Ergotron WorkFit-T — Desktop Sit-Stand Workstation	142
Ergotron WorkFit-TL — Desktop Sit-Stand Workstation	143
Ergotron WorkFit-TX — Standing Desk Converter	144
Ergotron WorkFit-Z Mini — Sit-Stand Desk Converter	145
Grommet Mount	146
Conversion Kit Single HD to Dual	146
Worksurface	147
Large Keyboard Tray	147
Tablet/Document Holder	147

Table of Contents

Conversion Kit: Dual to LCD & Laptop	148
Conversion Kit: LCD & Laptop to Dual	148
Tall-User Kit for WorkFit Dual	148
Deep Keyboard Tray	149
Corner Keyboard Tray	149
WorkFit Single LCD Monitor Kit	150
WorkFit Dual Monitor Kit	150
WorkFit LCD & Laptop Kit	150
Dual Monitor Double-Hinged Bow	151
Tall-User Kit for Single Display	151
Ergotron WorkFit — Anti-Fatigue Floor Mat	152
Ergotron Neo-Flex Laptop Cart	153
Ergotron Teachwell® Mobile Digital Workspace	154
LearnFit Desk	155
Storage Bin	155
Ergotron Zip 12 Charging	156
Grommets	
Grommets	157
Flip Top Unit — Hatch	158
Information Display	
Markerboard Accessories	159
Lighting — Haworth	
Adaptable LED Task Light - Stand-Alone	160
Adaptable LED Task Light - Starter Kit	160
Adaptable LED Task Light - Add-On Kit	161
Reed Premier™ Stand-Alone LED Task Light	162
Reed Premier™ Starter LED Task Light	162
Reed Premier™ Add-On LED Task Light — For Use with Reed Premier Starter LED Task Lights	163
Reed Premier™ Add-On Occupancy Sensor	163
Voyage without Occupancy Sensor	164
Voyage with Occupancy Sensor	164
Freestanding Lighting	165
Mounted Lighting	165
Grommet — For Use with Brazo Grommet Mounted Light Only	165
Circa Table Light	166
Circa Floor Light	166
Contour Table Light	167
Contour Floor Light	167
Giraffa Table Light	168
LIM Freestanding Lighting	169
LIM Worksurface Mounted Lighting	170
LIM Mounted Lighting	171
LIM Hardware	172
LIM 360 Table Light	173
LIM 360 Grommet Mounted Light	173
Pixo Table Light	174
Superlight Table Light	175
Superlight Floor Light	175
Superlight Base Pads	175
Tube Top Table Light	176
Tube Top Floor Light	176
UMA Audio Lantern	177
Recycling Solutions	
Recycling Solutions	178
Recycling/Trash Bin	178
Storage — Belong	
Suspended Pedestal	179
Storage Accessories — Belong	
PDA Tray	180
Dividers	180

Personal Tray	180
Pencil Tray	180
Security Drawer	181
Top Liner — Security Drawer	181
Drawer Liner	181
Personal Storage Hook	181
File Partition	182
Drawer Tray	182
Magnetic Divider	182
Cushion Top	183
Wire Management	
Cable Chain	184
Compose Connections Cable Chain	184
J-Channel	185
Conduit Clamp	185
Wire Management Loop	185
Wire Manager Clips	185
Wire Manager — Horizontal	186
Horizontal Wire Management	186
Vertical Cable Guide	186
Height Adjustable Table - Belong Horizontal	187
Wire Management Basket	187
Basket Cover	187
Vertical Wire Channel - Leg Attached	187
Planes C-Leg Training Table Vertical Wire Manager	188
Compose Task Light Cord Manager	188
UniGroup Too, UniGroup and PLACES Wire Manager	188
Work Tools — Mounting	
Slat, Wall Mount	189
Single Side	190
Tool Rail — Horizontal Surface Mount C-Clamp or Thru-Mount	191
Tool Rail — Single Post — C-Clamp or Thru-mount	192
Tool Rail — Under Horizontal Surface Mount — L-Bracket	193
Tool Rail — Single Post — L-Bracket Mount	194
Tool Rail — Single Sided Continuous Benching End	195
Tool Rail — Double-Sided Continuous Benching End Application Only	196
Tool Rail — Internal Single Sided Continuous Benching Application	197
Tool Rail — Internal Continuous Benching Application Only	198
Tool Rail — Single Post Internal/Benching	198
Belong Systems Tile — External Mount for use with Compose Panels	199
Work Tools — Belong	
Open C Cubby	200
Trays	200
Base Tray	201
Desk Top L-Screen	201
Desk Top Reference Shelf	201
Paper Tray — Landscape	202
Tool Cup	202
Hanging Sorter	202
Mini Shelf	202
Blotter	203
Reference Shelves	203
Accessory Kit	203
Work Tools — Jump Stuff	
Paper Sorter	204
Binder Bin	204
Mini Shelf	204
Phone Shelf	204
Letter Tray	205
Waste Bin	205

Table of Contents

Work Tools — Magnetic Accessories

Magnet Board	206
Magnet Hooks	206
Magnet Hook	206
Round Peg Magnets	206
Mirror	206

Workstation Accessories

Shallow Drawer	207
Steel Center Drawer	207
Pencil + Drawer	207
Pencil Drawer	207
Make-A-Corner	207
Compose All-Purpose Hook	208
PLACES All-Purpose Hook	208
UniGroup All-Purpose Hook	208
UniGroup Too All Purpose Hook	208
Bag Hook	208
2/90 Sign Systems	209

Lock Programs

HW Lock Plugs and Keys	213
HW Plugs and Keys	214
HW Replacement Keys	214
HW Master Key	214
HW Control Key	214
HW Key Blank	214
Digital Lock	215
Digital Lock Control Key Fob	215

Finishes

Finish/Color Legend	223
---------------------------	-----

Index	225-231
--------------------	---------

Ergotron Warranty	232
--------------------------------	-----

Lifetime Product Warranty	Inside Back Cover
--	-------------------

Statement of Line

Electrical Components – Belong — pages 21-25

<p>EUC4 Power Cube</p>	<p>EUR1 Plug Strip</p>	<p>EUB5 Power Suite</p>	<p>Wire Management Tray</p>	<p>EUWT Wire Management Tray</p>
<p>Knife Edge Worksurface Mount</p>	<p>Knife Edge Worksurface Mount</p>	<p>Knife Edge Worksurface Mount</p>	<p>Above Worksurface Application (Bracket NOT Fastened or Needed)</p>	
<p>EUCB-WJP Standard Edge Worksurface Mount</p>	<p>EUCB-WFP Knife Edge Worksurface Mount</p>	<p>EUCB-TJP Knife Edge Worksurface Mount</p>	<p>EUUB-UP Above Worksurface Application</p>	<p>EUAC Cord Management Cuff</p>

Electrical Components – Belong Power Tap — pages 26-28

<p>EUET-0030-3M3N EUET-0030-2M3N EUET-0030-4M3N Horizontal</p>	<p>EUET-0030-3M3N EUET-0030-2M3N EUET-0030-4M3N Vertical</p>	<p>EUET-0030-CM3N Horizontal Hard Wired</p>	<p>EUET-0030-CM3N Vertical Hard Wired</p>	<p>EUET-0000-1M3N Horizontal Corded</p>	<p>EUET-0000-1M3N Vertical Corded</p>

Electrical Components – Belong Power Tap Brackets — pages 29-30

<p>ZUAP-0000-PFD Fixed</p>	<p>ZUAP-0000-PAN Adjustable</p>	<p>ZUAP-0000-PUR Under Surface</p>	<p>ZUAP-0000-PGH with Grommet Beside Storage Only</p>

Statement of Line

Electrical Components — page 31

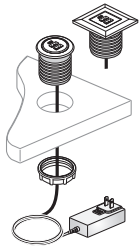

EURT-0072-1010
EURT-00E4-1010
Bezel Utility Model
USB Charging: Round
or Square

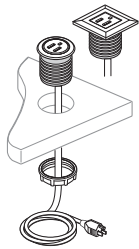

EURT-0072-1100
EURT-00E4-1100
Bezel Utility Model
Power Outlet: Round
or Square

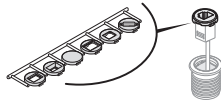

EURT-0000-N001CB
EURT-0000-N001CW
Bezel Utility Model
Round Data Bezel

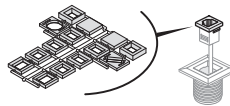

EURT-0000-N001SB
EURT-0000-N001SW
Bezel Utility Model
Square Data Bezel

Electrical Components – Cables — page 32

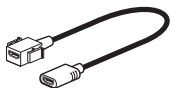

EUDX-H000-B
Cable

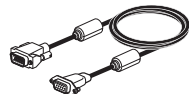

EUDX-V000-B
Cable



EUDX-3000-B
Cable

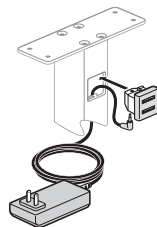

EUDX-U000-B
Retrofit USB Charging
Cable

Electrical Components — pages 33-35

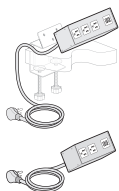

EUF1
Classic Power
Module

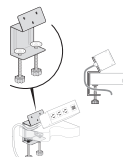

EUFB-0000-AB
Classic Power
Module Bracket - Angled

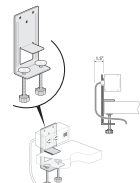

EUFB-0000-SB
Classic Power
Module Bracket - Vertical
Bracket

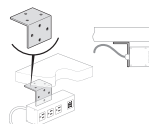

EUFB-0000-UB
Classic Power
Module Bracket - Under
Surface

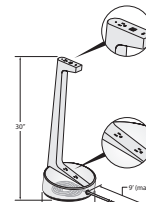

EUCN-PJ
Collaborative
Power Station

Electrical Components – Enhanced Power Module — pages 37-53

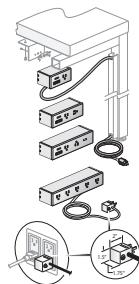

EUS1-PF0B
EUS1-PF0W
EUS1-HLOB
EUS1-HLOW
Seamless Enhanced
Power Module



EUD1-PF0B-2010
3-Port Power
Cord



EUD1-PF0B-2110
4-Port Power
Cord

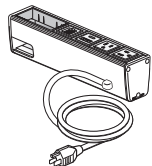

EUD1-PF0B-2112
6-Port Power
Cord

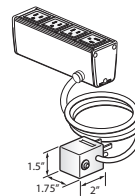

EUD1-PF0B-4000
4-Port Power
Cord
Circuit Breaker Plug



EUD1-HF0B-2010
3-Port Hard
Wired



EUD1-HF0B-2110
4-Port Hard
Wired

Statement of Line

Electrical Components – Enhanced Power Module (cont'd) — pages 37-53

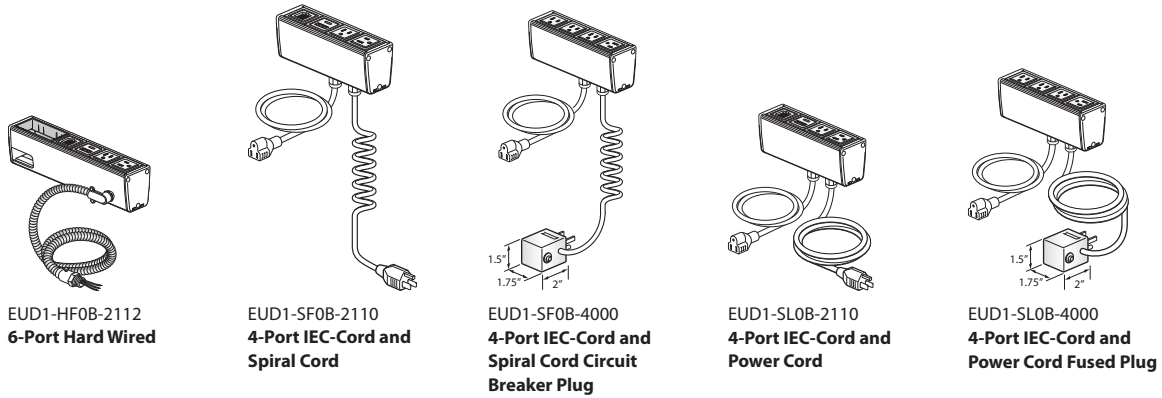

Electrical Components – Enhanced Power Module Brackets — pages 54-56

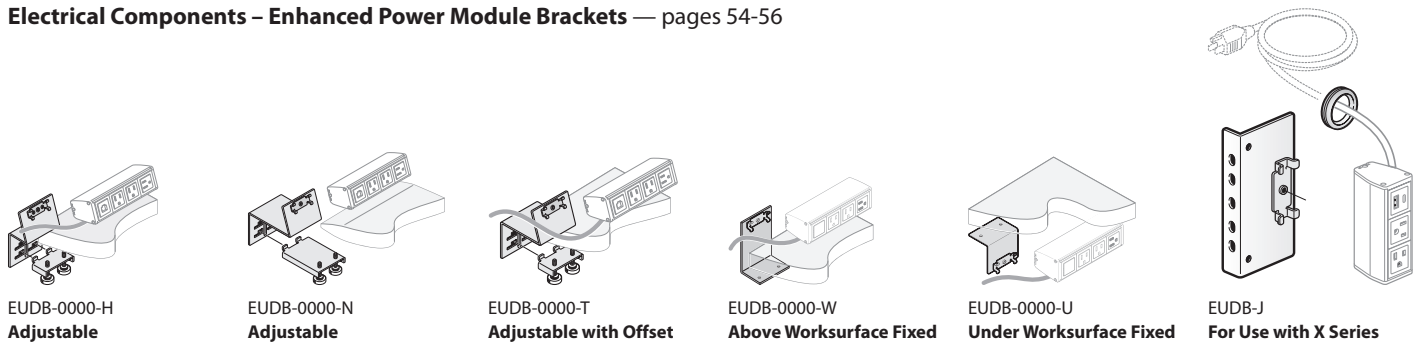

Electrical Components – Flip Top Units with Smooth Bezel — pages 57-71

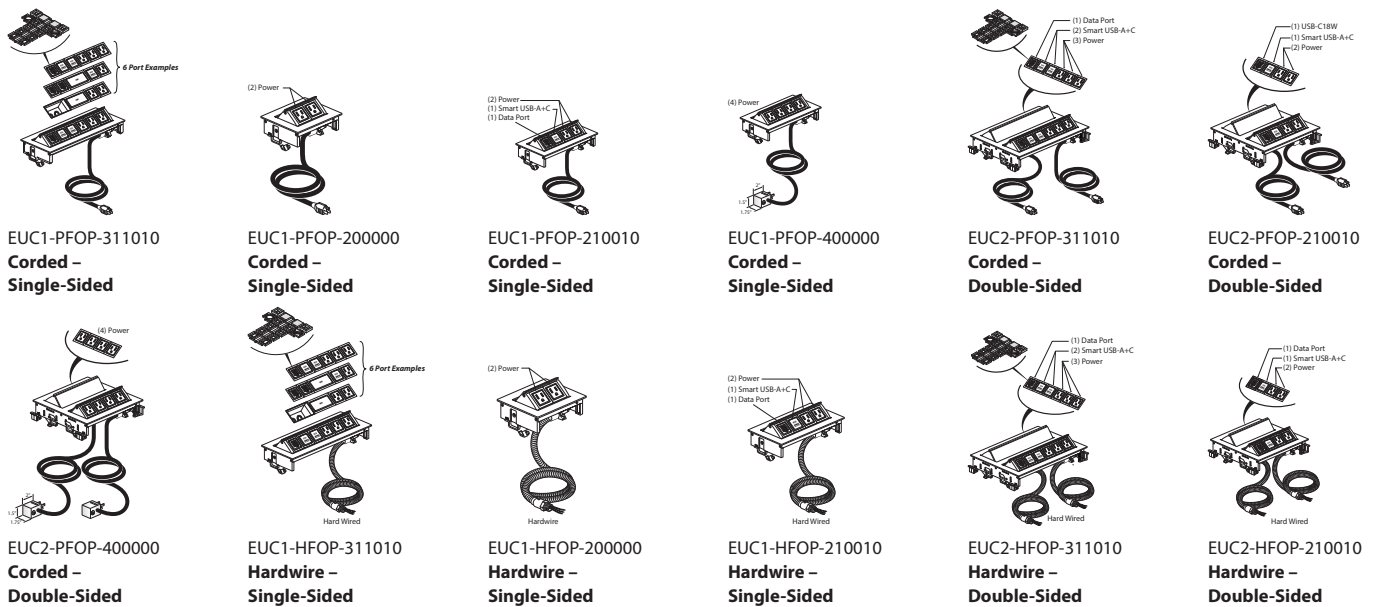

Statement of Line

Electrical Components – Flip Top Units — pages 73-97

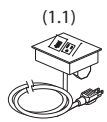

(1.1)
EUE1-1111W
Single Sided Corded

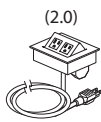

(2.0)
EUE1-1B01W
Single Sided Corded

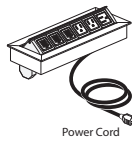

Power Cord
EUE1-1331W
Single Sided Corded

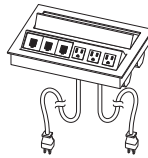

EUE2-1331W
Double Sided Corded

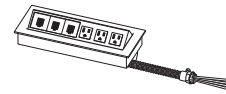

EUE1-C331W
Single Sided Hard Wired

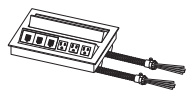

EUE2-C331W
Double Sided Hard Wired

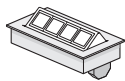

EUE1-000B
Single Sided
Non Powered

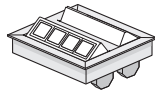

EUE2-000B
Double Sided
Non Powered



EUE1-PF0B-2110
4-Port Flip Top Unit –
Corded – Single-Sided

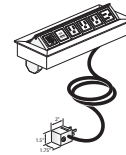

EUE1-PF0B-1212
6-Port Flip Top Unit –
Corded – Single-Sided

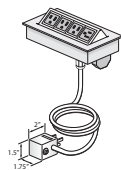

EUE1-PF0B-4000
4-Port Flip Top Unit –
Corded – Single-Sided –
Circuit Breaker Plug



EUE2-PF0B-2110
4-Port Flip Top Unit –
Corded – Double-Sided

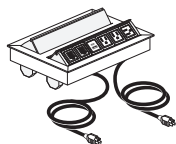

EUE2-PF0B-1212
6-Port Flip Top Unit –
Corded – Double-Sided

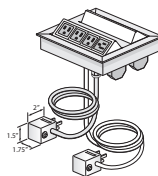

EUE2-PF0B-4000
4-Port Flip Top Unit –
Corded – Double-Sided –
Fused Plug

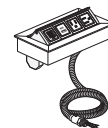

EUE1-HF0B-2110
4-Port Flip Top Unit –
Hardwire – Single-Sided

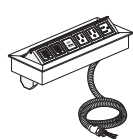

EUE1-HF0B-1212
6-Port Flip Top Unit –
Hardwire – Single-Sided

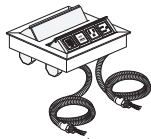

EUE2-HF0B-2110
4-Port Flip Top Unit –
Hardwire – Double-Sided

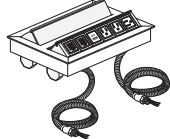

EUE2-HF0B-1212
6-Port Flip Top Unit –
Hardwire – Double-Sided

Electrical Components – Flush Mounted — pages 99-113



EUB1-PL0B-2100
3-Port Power Cord



EUB1-PL0B-2110
4-Port Power Cord

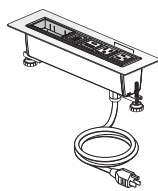

EUB1-PL0B-2112
6-Port Power Cord

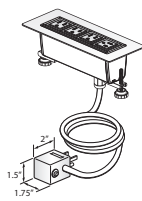

EUB1-PL0B-4000
4-Port Power Cord
Circuit Breaker Plug



EUB1-HL0B-2100
3-Port Hard Wired



EUB1-HL0B-2110
4-Port Hard Wired

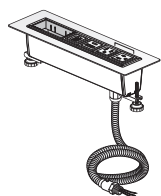

EUB1-HL0B-2112
6-Port Hard Wired

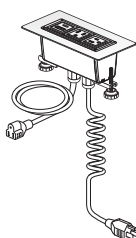

EUB1-SF0B-2100
3-Port IEC-Cord
and Spiral Cord

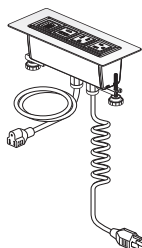

EUB1-SF0B-2110
4-Port IEC-Cord
and Spiral Cord

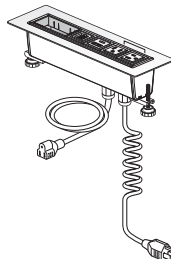

EUB1-SF0B-2112
6-Port IEC-Cord
and Spiral Cord

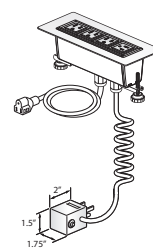

EUB1-SF0B-4000
4-Port IEC-Cord and Spiral
Cord Circuit Breaker Plug

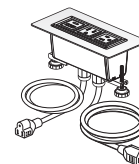

EUB1-SL0B-2100
3-Port IEC-Cord
and Power Cord

Statement of Line

Electrical Components – Flush Mounted (cont'd) — pages 99-114

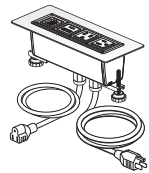

EUB1-SLOB-2110
4-Port IEC-Cord
and Power Cord

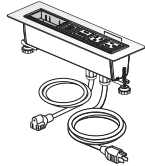

EUB1-SLOB-2112
6-Port IEC-Cord
and Power Cord

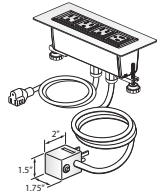

EUB1-SLOB-4000
4-Port IEC-Cord
and Power Cord
Breaker Plug

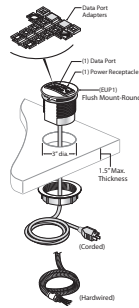

EUP1-PF
EUP1-HF
Flush Mounted
Round

Electrical Components – Wireless Charging Module — page 115

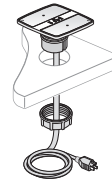

EUWC-PF0B
EUWC-PF0W
EUWC-HL0B
EUWC-HL0W
Wireless Charging
Module

Ergotron Keyboard Tray — page 116



169BK
Keyboard Tray with
Mouse Pad



UKMCKBK
Keyboard Tray with
Mouse Pad

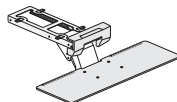

97-582-009
Neo-Flex Keyboard
Tray

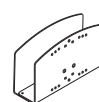

80-063
Small CPU Holder

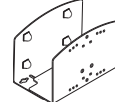

97-468
Universal CPU Holder



80-105-064
Cable CPU Holder

Ergotron CPU Holders — page 117

Ergotron Monitor Arms – HX and LX Arms — pages 118-123

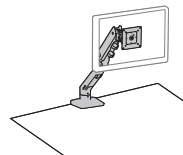

45-475
45-478
HX Single Arm

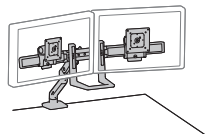

45-476
45-479
HX Dual Arm

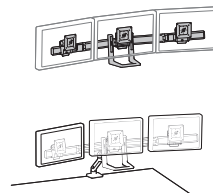

98-009-026
98-009-216
HX Triple Monitor
Bow Kit

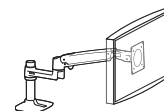

45-241
45-490
45-295
45-537
45-626
LX Desk Mount
Single Arm

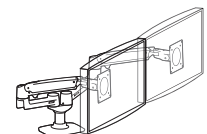

45-245
45-491
LX Desk Mount
Dual Arm

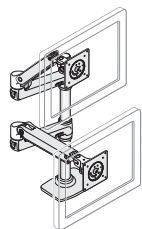

45-248
45-492
LX Desk Mount
Dual Arm

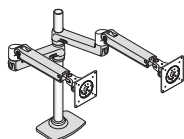

45-549-026
45-509-216
LX Dual Stacking Arm -
Tall Pole Monitor Arm

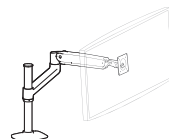

45-360-026
45-384-026
LX Sit-to-Stand Mount
Single Arm

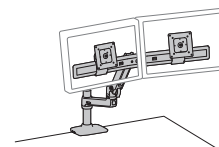

45-489
45-627
LX Desk Dual Direct Arm



98-037-062
LX Desk Dual Direct
Handle Kit

Statement of Line

Ergotron Monitor Arms – LX Arms Accessories — pages 124-125

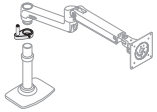

97-774-003
LX One-Stop Rotational Control Kit

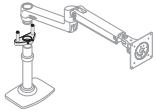

98-060-003
LX Two-Stop Rotational Control Kit

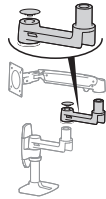

45-289-026
LX Extension

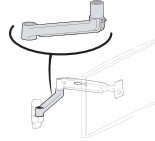

45-362-026
LX Sit-to-Stand Extension



97-844
LX Pole Collar

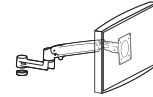

97-940-026
98-130-216
LX Arm, Extension and Collar Kit

Ergotron Monitor Arms – MXV Desk Mount — page 126

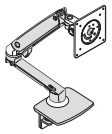

45-486
45-625
MXV Desk Mount Single Arm

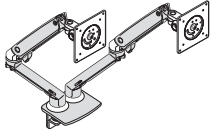

45-496
MXV Desk Mount Dual Arm

Ergotron Monitor Arms – MX — page 127

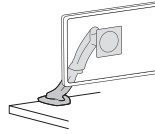

45-214-026
MX Desk Mount Single Arm

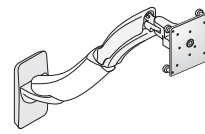

45-228-026
MX Wall Mount Heavy Duty

Ergotron Monitor Arms – Accessories — page 128

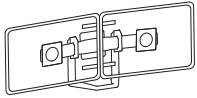

97-783
Dual Monitor and Handle Kit



60-589-060
Monitor Quick Release LCD Bracket

Ergotron Monitor Arms – Mounting Options — page 129

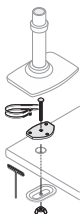

98-034
Grommet Mount

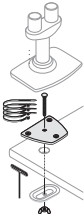

98-035
Grommet Mount

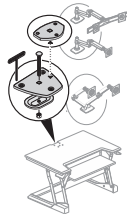

98-017
Grommet Mount



98-110
Grommet Mount



98-111
Grommet Mount

Ergotron Monitor Arms Accessories – Top Mount — page 130

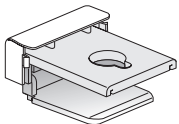

98-477
98-478
Top Mount Low Profile C-Clamp

Ergotron Monitor Mount – TRACE — pages 131-132

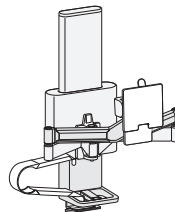

TDS-MA-PA
TDS-MA-FS
TDS-MA-GR
Single Monitor

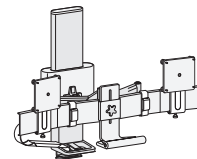

TDD-MA-PA
TDD-MA-FS
TDD-MA-GR
Dual Monitor

Statement of Line

Ergotron Monitor Mount Accessories – TRACE — page 133

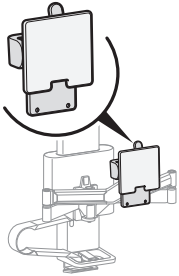

47-109-224
Single Conversion Kit

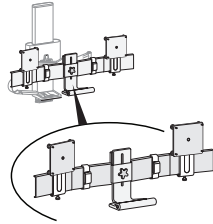

47-110-224
Dual Conversion Kit

Ergotron WorkFit — pages 134-145

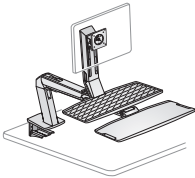

24-317-026
WorkFit-A Single Attached Sit-Stand Workstation

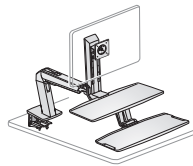

24-390-026
WorkFit-A Single Attached Sit-Stand Workstation

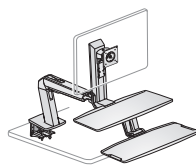

24-391-026
WorkFit-A Single Attached Sit-Stand Workstation

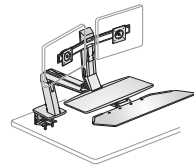

24-316-026
WorkFit-A Dual Attached Sit-Stand Workstation

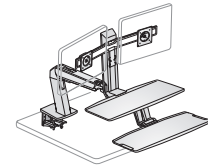

24-392-026
WorkFit-A Dual Attached Sit-Stand Workstation

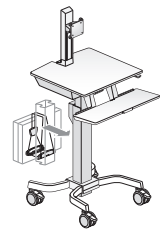

24-215-085
24-216-085
WorkFit-C Single Monitor

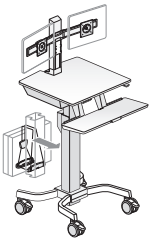

24-214-085
WorkFit-C Single Monitor

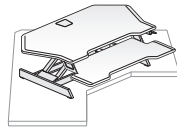

33-468-921
WorkFit Corner — Standing Desk Converter

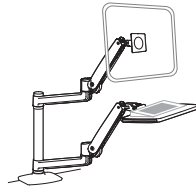

45-405-026
WorkFit-LX Sit-Stand Desk Mount System

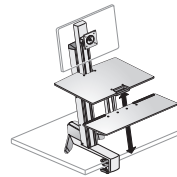

33-350-200
WorkFit-S Single Attached Sit-Stand Workstation

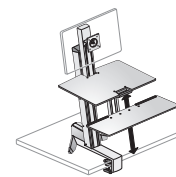

33-351-200
WorkFit-S Single Attached Sit-Stand Workstation

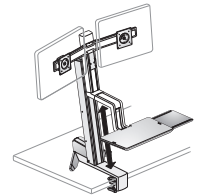

33-341-200
WorkFit-S Dual Attached Sit-Stand Workstation

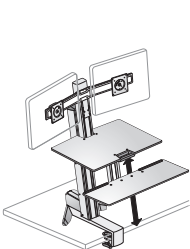

33-349-200
33-349-211
WorkFit-S Dual Attached Sit-Stand Workstation

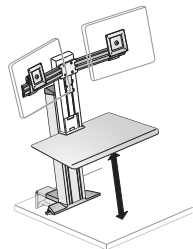

33-407-085
33-407-062
WorkFit-SR Dual Attached Sit-Stand Workstation

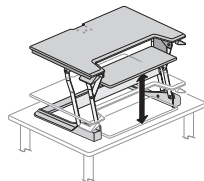

33-397-085
33-397-062
WorkFit-T Desktop Sit-Stand Workstation

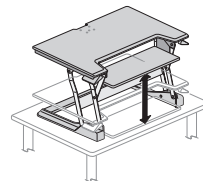

33-406-085
33-406-062
33-418-085
WorkFit-TL Desktop Sit-Stand Workstation

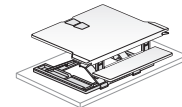

33-467-921
WorkFit-TX Sit-Stand Desk Converter

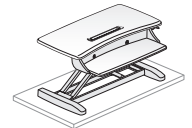

33-458-917
WorkFit-Z Mini Sit-Stand Desk Converter

Statement of Line

Ergotron WorkFit – Accessories — pages 146-152

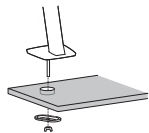

97-692
WorkFit-A Grommet Mount

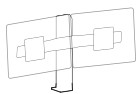

97-606
WorkFit-A Conversion Kit Single HD to Dual

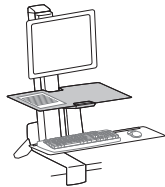

97-581-019
WorkFit-S Worksurface

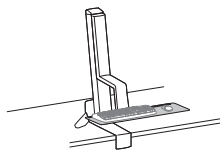

97-653
WorkFit-S Large Keyboard Tray



97-558-200
WorkFit-S Tablet/Document Holder

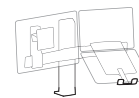

97-617
WorkFit-A/WorkFit-S Conversion Kit: Dual to LCD & Laptop

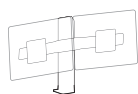

97-616
WorkFit-A/WorkFit-S Conversion Kit: LCD & Laptop to Dual

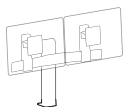

97-615
WorkFit-A/WorkFit-S Tall-User Kit for WorkFit Dual

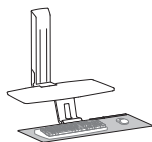

97-897
WorkFit-A/WorkFit-S Deep Keyboard Tray



97-898
WorkFit-A/WorkFit-S Corner Keyboard Tray

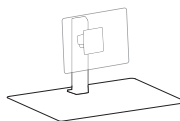

97-935
WorkFit-T/WorkFit-TL Single LCD Monitor Kit

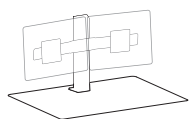

97-934
WorkFit-T/WorkFit-TL Dual LCD Monitor Kit

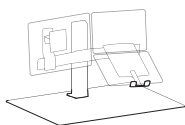

97-933
WorkFit-T/WorkFit-TL LCD & Laptop Kit

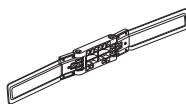

98-101-009
Dual Monitor Double-Hinged Bow



97-845
Tall-User Kit for Single Display

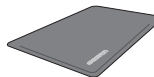

97-620-060
Anti-Fatigue Floor Mat

Ergotron Neo-Flex Laptop Cart — page 153



24-205-214

Ergotron LearnFit — page 155

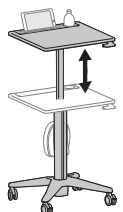

24-547-003
24-481-003
LearnFit Desk

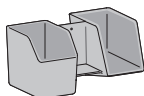

97-926-064
Storage Bin

Ergotron Teachwell® Mobile Digital Workspace — page 154



24-220-055

Ergotron Zip 12 Charging — page 156

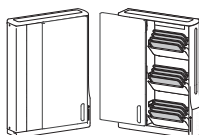

DM12-1006-1

Statement of Line

Grommets — pages 157-158

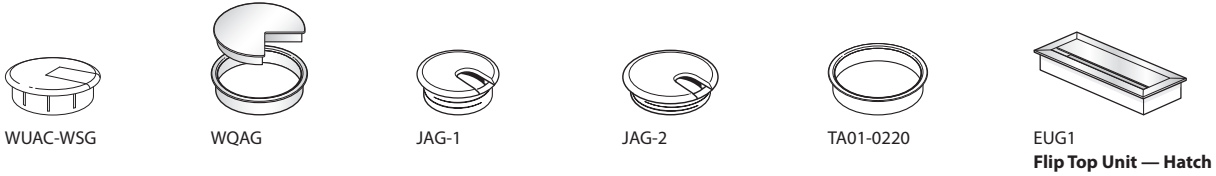

Markerboard Accessories — page 159



Lighting — pages 160-177

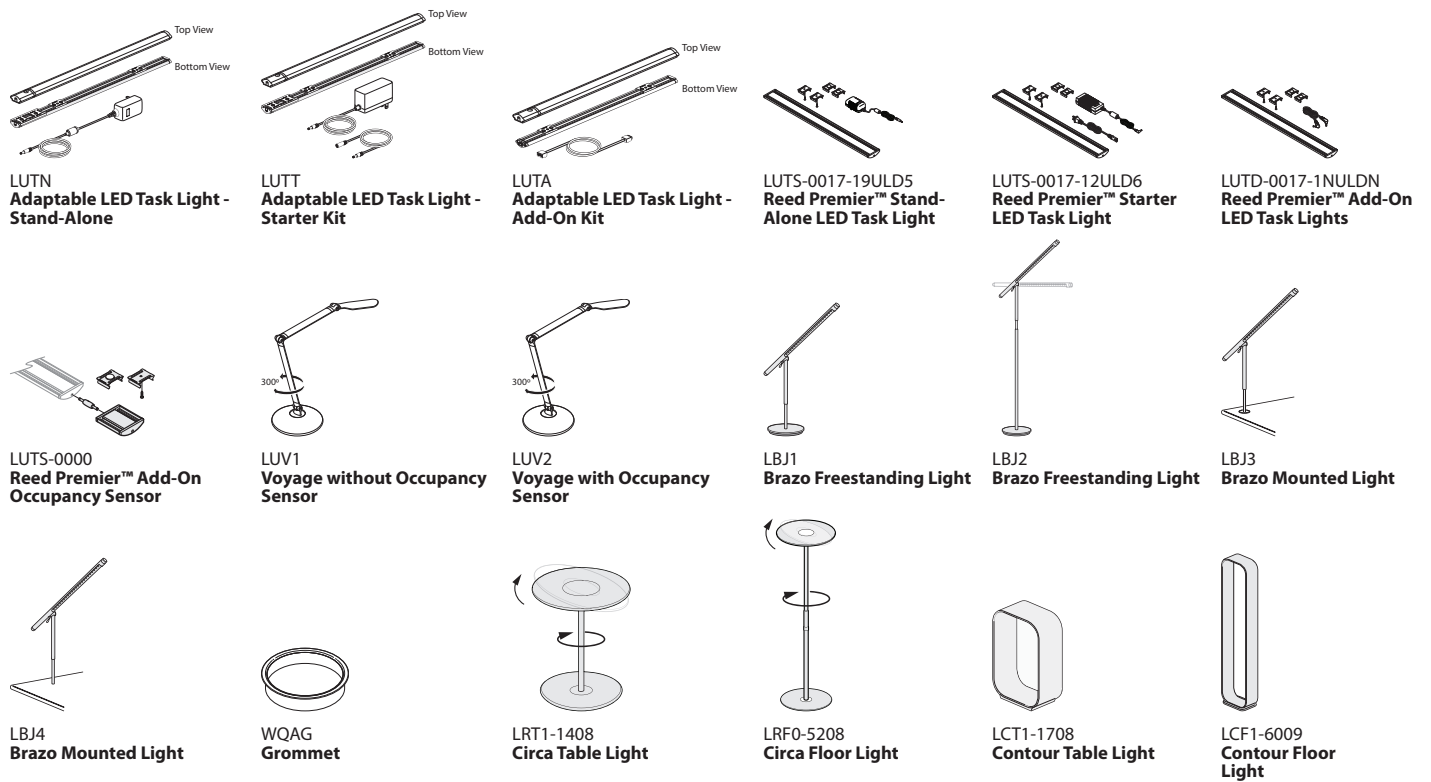

Statement of Line

Lighting (cont'd) — pages 160-177

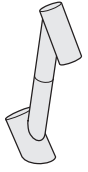

HCPL-GFT1-13
Giraffa Table Light

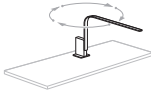

LLL1
LIM Table Light with Block

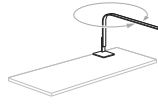

LLL2
LIM Table Light with Pivot



LLL3
LIM Floor Light

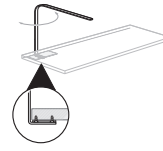

LLC1
LIM Worksurface Mounted Light

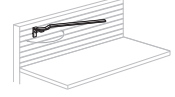

LLM1
LIM Mounted Light - Slat

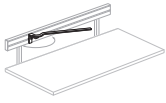

LLM1
LIM Mounted Light - Belong Rail

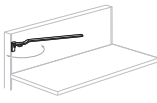

LLM2
LIM Mounted Light - Panel

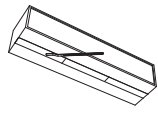

LLU2
LIM Mounted Light - Under Shelf

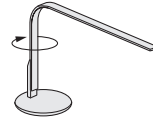

LL31-2210-NFLC
LIM 360 Table Light

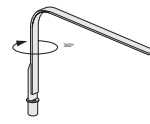

LL32-2210-NGLC
LIM 360 Grommet Mounted Light

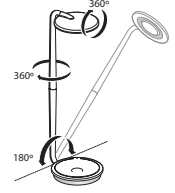

LUPT
Pixo Table Light

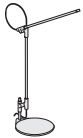

HCPL-SLT1-17
Superlight Table Light



HCPL-SLF1-47
Superlight Floor Light

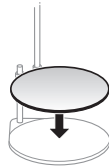

HCPL-SLSV-4BP
Superlight Base Pads

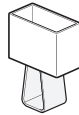

HCPL-TTT1-14
Tube Top Table Light

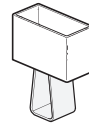

HCPL-TTT2-21
Tube Top Table Light

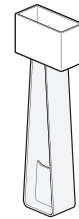

HCPL-TTF1-60
Tube Top Floor Light

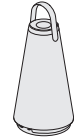

HCPL-UMT2-11
UMA Audio Lantern

Recycling Solutions — page 178

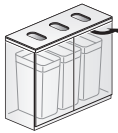

JRPy-3948

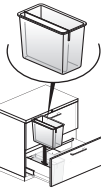

KURB
Recycling/Trash Bin

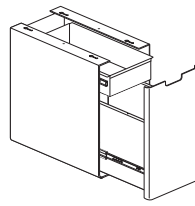

KUPA
Suspended Pedestal

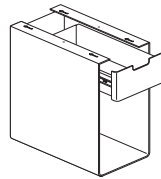

KUPD
Suspended Pedestal

Storage Accessories - Belong — page 180

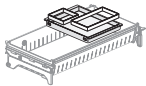

KJTY-12
PDA Tray

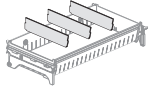

KDV
Dividers

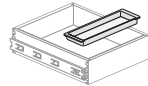

KJTY-10
Personal Tray

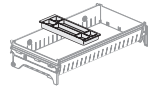

KJTY-9
Pencil Tray

Storage - Belong — page 179

Statement of Line

Storage – Belong — pages 181-183

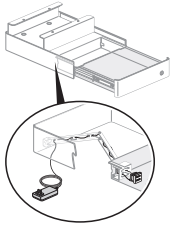

AHDD-SU
Security Drawer

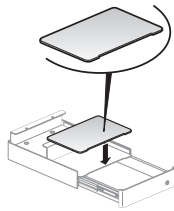

ALTD-S
Top Liner — Security Drawer

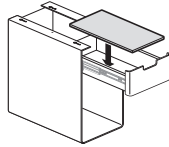

ALDD-F
Drawer Liner

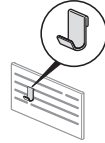

AA00-S
Personal Storage Hook

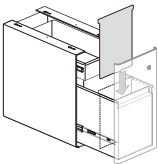

AA0P-S
File Partition

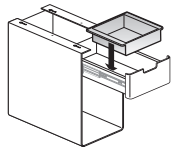

AA0T-S
Drawer Tray

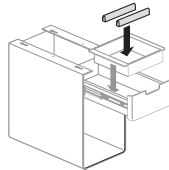

AA0D-S
Magnetic Divider

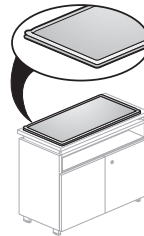

QBFC_F
Cushion Top

Wire Management — pages 184-188

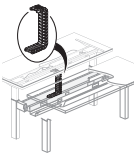

EAAW-0000-H
Cable Chain

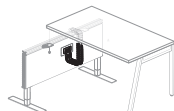

EUAW-4000-V
Compose Connections Cable Chain

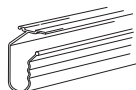

4TJC-72
J-Channel

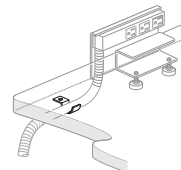

EUAM-0000
Conduit Clamp



NEH-8
Wire Management Loop

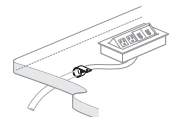

TA01-0225
Wire Manager Clips

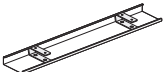

EUAW-NH
Wire Manager — Horizontal



WUAW-PNH
Horizontal Wire Management



NECG-V
Vertical Cable Guide

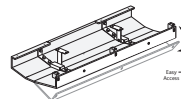

AKWN
Height Adjustable Table - Belong Horizontal

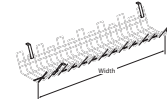

TAWB
Wire Management Basket

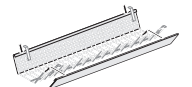

TABC
Basket Cover

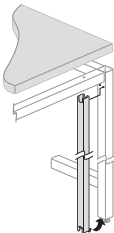

TYVW
Vertical Wire Channel — Leg Attached



TA01-0228-F
Planes C-Leg Training Table Vertical Wire Manager



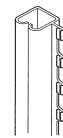

VZAW-0000-V
Compose Task Light Cord Manager







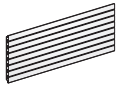
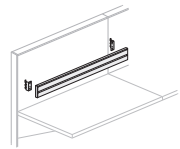
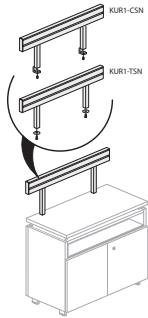
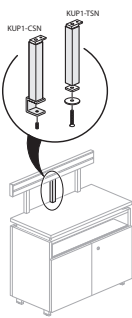
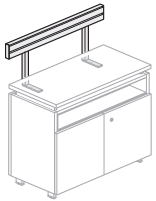

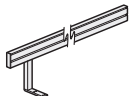
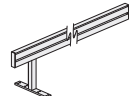
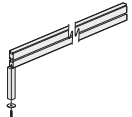
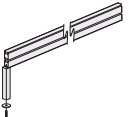
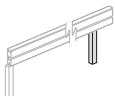
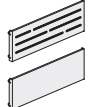

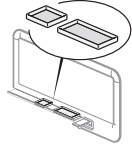
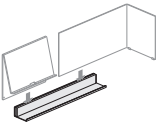
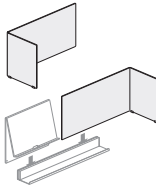
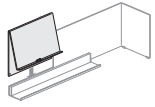
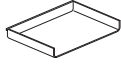

WC-6
UniGroup Too, UniGroup and PLACES Wire Manager

Statement of Line

Work Tools – Mounting — pages 189-199

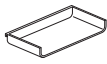
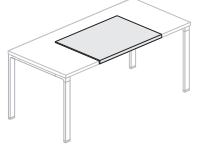
					
KUPY Slat, Wall Mount	KUR1-0424-PZN Belong Single Side	KUR1-CSN KUR1-TSN Belong Tool Rail — Horizontal Surface Mount C-Clamp or Thru-Mount	KUP1-CSN KUP1-TSN Belong Tool Rail — Single Post — C-Clamp or Thru-mount	KUR1-1224-USN Belong Tool Rail — Under Horizontal Surface Mount — L-Bracket	KUP1-0000-USN Belong Tool Rail — Single Post — L-Bracket Mount
					
KUR1-1224-USE Belong Tool Rail — Single Sided Continuous Benching End	KUR2-1224-UBE Belong Tool Rail — Double-Sided Continuous Benching End Application Only	KUR1-1224-USI Belong Tool Rail — Internal Single Sided Continuous Benching Application	KUR2-1224-UBI Belong Tool Rail — Internal Continuous Benching Application Only	KUP2-0000-UBI Belong Tool Rail — Single Post Internal/Benching	KZTB Belong Systems Tile — External Mount for use with Compose Panels

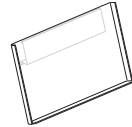
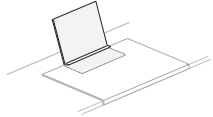
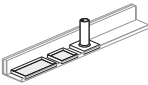
Work Tools — pages 200-206

					
KUCU-0915-BNN Belong Open C Cubby No Slots	KUCU-1215-BNS Belong Open C Cubby With Slots	KUAK Trays	KUBT Belong Base Tray	KULS Belong Desk Top L-Screen	KURS Belong Desk Top Reference Shelf
					
KUPT-0913-H Belong Paper Tray	KUPT-0913-F Belong Paper Tray	KUTC-0000-H Belong Tool Cup	KUHS-0000-H Belong Hanging Sorter	KUSH-0408-H Belong Mini Shelf	KUBL-2030-FJ Belong Blotter
					
KURS-0010-H Belong Reference Shelf	KURS-0019-H Belong Reference Shelf	KURS-0012-B Belong Reference Shelf	KUAK Belong Accessory Kit	DTPR-3 Jump Stuff Paper Sorter	

Statement of Line

Work Tools (cont'd) — pages 200-206

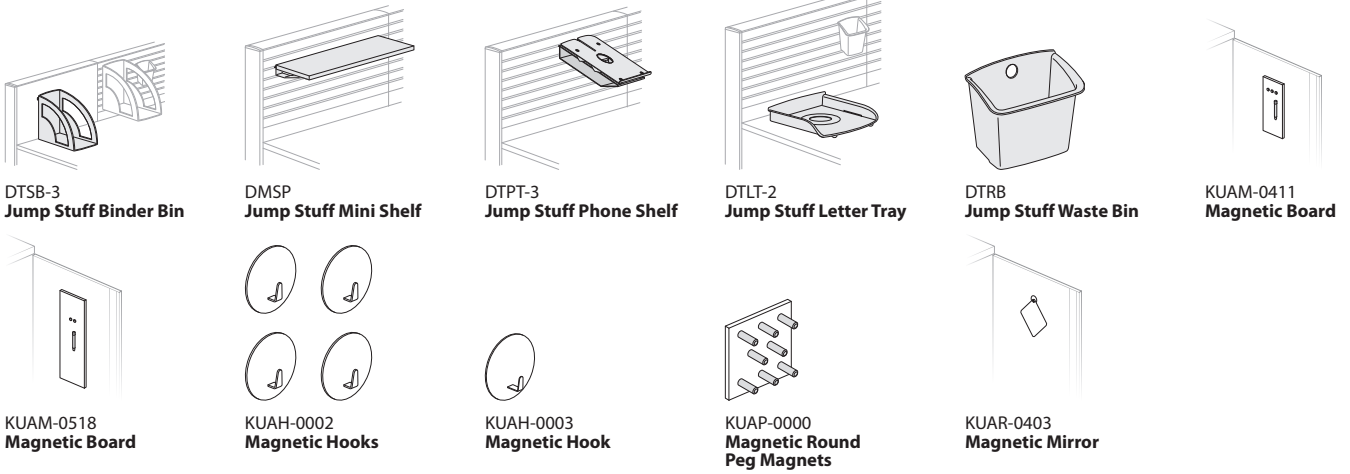

Workstation Accessories — pages 207-208

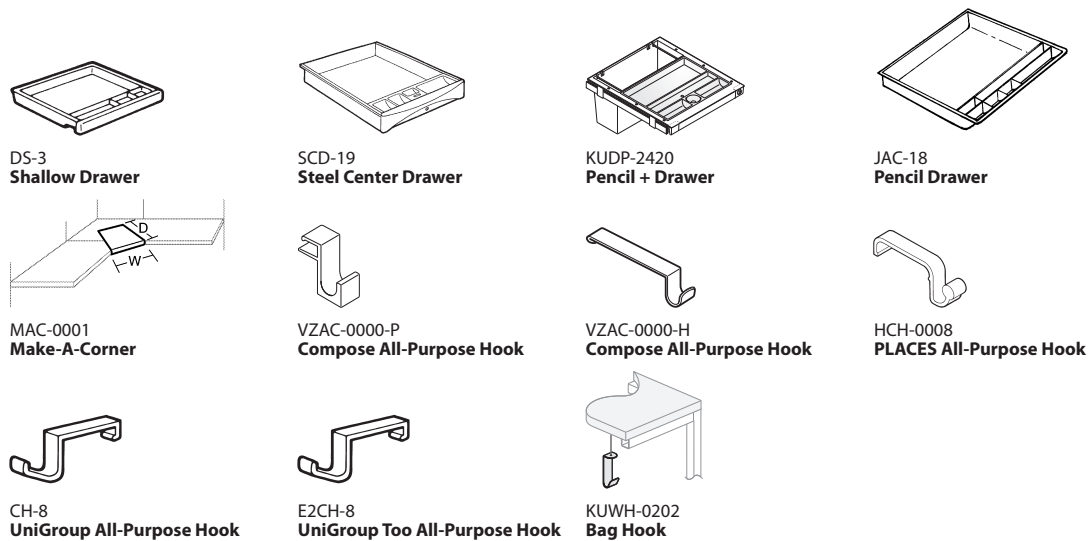

Lock Programs — pages 213-215

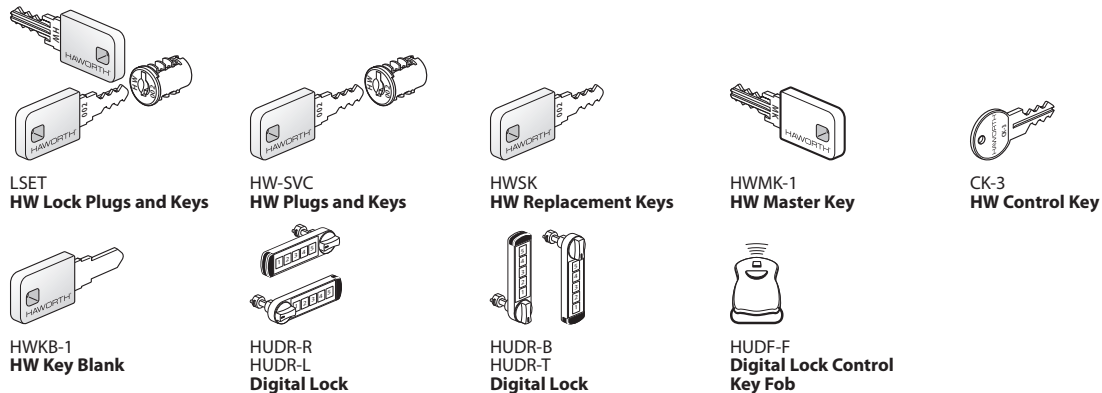

This page intentionally blank

Electrical Components

Belong

	Number	Price
Power Cube	EUC4-BIN1-31100YN	\$349.07

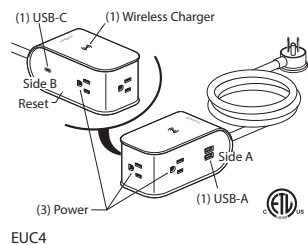

EUC4

Features

- Includes one power module with three 120V receptacles (NEMA 5-15R), one dual USB-A charging port, one USB-C charging port, one wireless charger, and 9’ (2743mm) hinged braided power cord with low profile plug (NEMA 5-15P).
- Can be freestanding on worksurface or be used with appropriate mounting bracket.
- 10W wireless charger on top of cube.
- USB-A and USB-C share 15W charging capability.
- USB-A provides two ports.
- USB-C provides one port for fast charge for a mobile phone.
- Power Cube has non-slip pad on bottom.

To Order, Specify:

- 1) Product number.
- 2) Trim color.
TR-K Charcoal
TR-FM Snow

Specification Tips

- Available in charcoal TR-K or snow TR-FM.
- Brackets (EUCB) are optional and can be separately specified.
- Application may require approval of local authority having jurisdiction (AHJ); ensure compliance before placing orders and installation.

Plug Strip

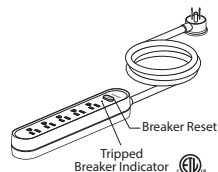

EUR1

	Number	Price
Plug Strip	EUR1-BIN1-50000	\$85.84

Features

- Includes one plug strip with five 120V receptacles (NEMA 5-15R), circuit breaker, and 9’ (2743mm) braided power cord with low profile plug (NEMA 5-15P).
- Plug Strip can mount in wire management tray or mount directly to the underside of the worksurface without additional bracket.
- Plug Strip has keyhole slots for mounting below worksurface.
- UL 962A listed Furniture Power Distribution Unit.

To Order, Specify:

- 1) Product number.
- 2) Trim color.
TR-K Charcoal
TR-FM Snow

Specification Tips

- Available in charcoal TR-K or snow TR-FM.
- Recommended for 23” (584mm) deep surfaces which cannot accommodate a wire management tray.
- Application may require approval of local authority having jurisdiction (AHJ); ensure compliance before placing orders and installation.

Power Suite

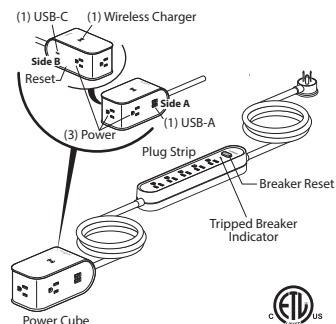

EUBS

	Number	Price
Power Suite	EUB5-BIN1-81100YN	\$406.30

Features

- Includes one power module with three 120V receptacles (NEMA 5-15R), one dual USB-A charging port, one USB-C charging port, one wireless charger, one connected plug strip with five 120V receptacles (NEMA 5-15R), circuit breaker, and 9’ (2743mm) hinged braided power cord with low profile plug (NEMA 5-15P).
- Cord connecting plug strip to power cube is 4’ (1219mm).
- Power Cube can be freestanding on worksurface or be used with appropriate mounting bracket. Plug strip can mount in wire management tray or mount directly to the underside of the worksurface without additional bracket.
- 10W wireless charger on top of cube.
- USB-A and USB-C share 15W charging capability.
- USB-A provides two ports.
- USB-C provides one port for fast charge for a mobile phone.
- Power Cube has non-slip pad on bottom.
- Plug Strip has keyhole slots for mounting below worksurface.
- Circuit breaker has a reset indicator light.

To Order, Specify:

- 1) Product number.
- 2) Trim color.
TR-K Charcoal
TR-FM Snow

Specification Tips

- Available in charcoal TR-K or snow TR-FM.
- Plug Strip designed to be mounted below worksurface for long term connection. Power Cube is mounted above the surface for a convenient power option.
- Recommended for 23” (584mm) deep surfaces which cannot accommodate a wire management tray.
- Application may require approval of local authority having jurisdiction (AHJ); ensure compliance before placing orders and installation.

Wire Management Tray General Specifications

Wire Management Tray

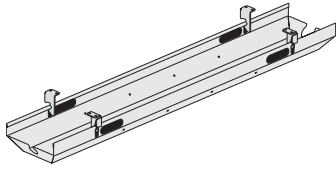

Product Name	Approved Table Depths	Approved Table Widths	Reduce Tray Width Leg Clearance	Example Calculation To Determine Tray Width
Upside – Height Adjustable Table C-Leg and T-Leg/ Rectangle Top	29"(737mm)	58"(1473mm), 64"(1626mm), 70"(1778mm), 76"(1930mm), 82"(2083mm)	22"(559mm)	64"(1626mm) Table Width - 22"(559mm) Reduce Tray Width 42"(1067mm) Tray Width
Planes – Height Adjustable Table C-Leg/Rectangle Top	29"(737mm)	58"(1473mm), 64"(1626mm), 70"(1778mm)	22"(559mm)	64"(1626mm) Table Width - 22"(559mm) Reduce Tray Width 42"(1067mm) Tray Width
Planes LT Model Height Adjustable Table C-Leg and T-Leg/ Rectangle Top	29"(737mm)	58"(1473mm), 64"(1626mm), 70"(1778mm)	22"(559mm)	64"(1626mm) Table Width - 22"(559mm) Reduce Tray Width 42"(1067mm) Tray Width
Masters Series Height Adjustable Table Rectangle Top	30"(762mm), 36"(914mm), 42"(1067mm)	60"(1524mm), 66"(1676mm), 72"(1829mm)	22"(559mm)	64"(1626mm) Table Width - 22"(559mm) Reduce Tray Width 42"(1067mm) Tray Width
Masters Series Height Adjustable Table with Storage Integration Rectangle Top	30"(762mm), 36"(914mm), 42"(1067mm)	66"(1676mm), 72"(1829mm), 78"(1981mm), 84"(2134mm)	30"(762mm)	66"(1676mm) Table Width - 30"(762mm) Reduce Tray Width 36"(914mm) Tray Width
Jive Table – Dual Disc Base Rectangle Top	30"(762mm), 36"(914mm), 42"(1067mm)	72"(1829mm), 84"(2134mm), 96"(2438mm)	36"(914mm)	72"(1829mm) Table Width - 36"(914mm) Reduce Tray Width 36"(914mm) Tray Width
Jive Table – T-Leg – Round Column Rectangle Top	36"(914mm)	66"(1676mm), 72"(1829mm), 84"(2134mm)	12"(305mm)	66"(1676mm) Table Width - 12"(305mm) Reduce Tray Width 54"(1372mm) Tray Width
Jive Table – T-Leg – Extruded Column Rectangle Top	30"(762mm), 36"(914mm)	54"(1372mm), 60"(1524mm), 66"(1676mm), 72"(1829mm)	18"(457mm)	60"(1524mm) Table Width - 18"(457mm) Reduce Tray Width 42"(1067mm) Tray Width
Jive Table – C-Leg Extruded and Round Column Rectangle Top	30"(762mm)	54"(1372mm), 60"(1524mm), 66"(1676mm), 72"(1829mm)	18"(457mm)	72"(1829mm) Table Width - 18"(457mm) Reduce Tray Width 54"(1372mm) Tray Width
Jive Table Post Round Base and Post Extruded Base Rectangle Top	30"(762mm), 36"(914mm)	42"(1067mm), 48"(1219mm), 54"(1372mm), 60"(1524mm), 66"(1676mm), 72"(1829mm), 84"(2134mm)	6"(152mm)	42"(1067mm) Table Width - 6"(152mm) Reduce Tray Width 36"(914mm) Tray Width
Adaptable Worksurface Rectangle Worksurface	30"(762mm)	42"(1067mm), 48"(1219mm), 54"(1372mm), 60"(1524mm), 72"(1829mm)	6"(152mm)	48"(1219mm) Table Width - 6"(152mm) Reduce Tray Width 42"(1067mm) Tray Width
Cultivate Table Frames	36"(914mm), 42"(1067mm)	60"(1524mm), 72"(1829mm) Wide Frames	12"(305mm)	60"(1524mm) Table Width - 12"(305mm) Reduce Tray Width 48"(1219mm) Tray Width
		84"(2134mm), 96"(2438mm) Wide Frames	12"(305mm)	84"(2134mm) Table Width - 12"(305mm) Reduce Tray Width 72"(1829mm) Tray Width (use two 36"(914mm) wide trays)

Electrical Components

Belong

Wire Management Tray

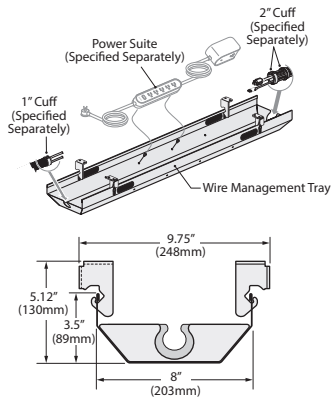

EUWT

Widths

- 36"(914mm)
- 42"(1067mm)
- 48"(1219mm)
- 54"(1372mm)
- 60"(1524mm)

Number

- EUWT-0836-P
- EUWT-0842-P
- EUWT-0848-P
- EUWT-0854-P
- EUWT-0860-P

Price

- \$242.30**
- 250.58**
- 258.86**
- 267.14**
- 275.42**

Features

- Includes one metal tray and four attachment brackets with thumb tabs to assist with opening tray.
- Tray flips down to provide access to power and data cords. It can be accessed by the back or the user side.
- Belong Plug Strip can be mounted into the tray.
- Tray can accept both the 1"(25mm) and 2"(51mm) Cuffs. Reverse tray for correct opening.

To Order, Specify:

- 1) Product number.
- 2) Trim color.

Specification Tips

- Tray width must be undersized due to the understructure of the table. See Wire Management Tray General Specifications application details.
- Not designed to be used on 23"(584mm) deep tables or worksurfaces due to knee clearance.
- 1.5H storage placed under a fixed worksurface will not have enough clearance for a Wire Management Tray.
- Not designed for use on Flip Top Tables (Planes or Jive).
- Product is available in all standard trim colors.

Electrical Components

Belong

	Description	Number	Price
Belong Power Cube 65W and Belong Power Suite 65W	Edgeband	EUCB-0000-WJP	\$ 57.23
	Knife Edge	EUCB-0000-WFP	131.62
	VSU/Tackboard	EUCB-0000-TJP	57.23
	Undersurface	EUUB-0503-UP	28.61

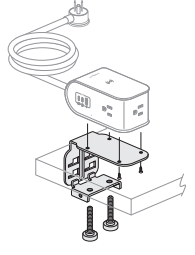

Standard Edge Worksurface Mount

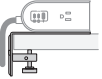

EUCB-WJP

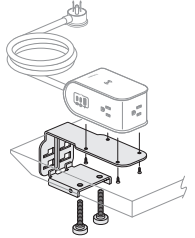

Knife Edge Worksurface Mount

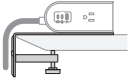

EUCB-WFP

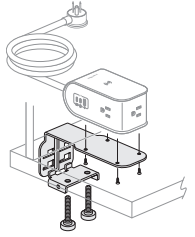

Knife Edge Worksurface Mount



EUCB-TJP

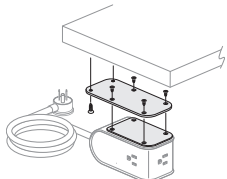

Under Worksurface Mount

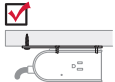

Above Worksurface Application
(Bracket NOT Fastened or Needed)

EUUB-UP

Features

- Includes mounting bracket and mounting hardware.
- For use with Belong Power Solutions cube and suite. Not for use with the Power Strip.

Specification Tips

- Accommodates 1.18" thick tops with clear space below.
- Available in standard finishes.
- Application may require approval of local authority having jurisdiction (AHJ); ensure compliance before placing orders and installation.

To Order, Specify:

- 1) Product number.
- 2) Trim color.

TR-K	Charcoal
TR-FM	Snow

Electrical Components

Belong

	Description	Number	Price
Cord Management Cuff	1"(25mm) Bag of 50	EUAC-0001-C	\$200.29
	2"(51mm) Bag of 26	EUAC-0002-C	160.23

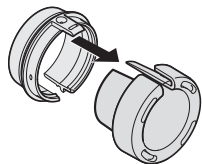

EUAC

Features

- Includes one bag of 26 - 2"(51mm) Cuffs or one bag of 50 - 1"(25mm) Cuffs.
- Product is applied to both ends of the separately specified Mesh Cord Manager and one end snaps into the Belong Wire Management Tray.

To Order, Specify:

- 1) Product number.

Specification Tips

- The size of the cuff aligns with the size of the Mesh Cord Wire Manager used.
- The Wire Management Tray can accept both the 1"(25mm) and 2"(51mm) cuff.
- Split cuff allows side insertion of cord or cable less than .5"(13mm) diameter. The shape or size of plug does not impede installation of cuff over cord cables.
- Available in charcoal TR-K only.
- Loom Insertion Tool Epart 2442-4401 is recommended for easier installation.

Mesh Cord Manager with Cuffs

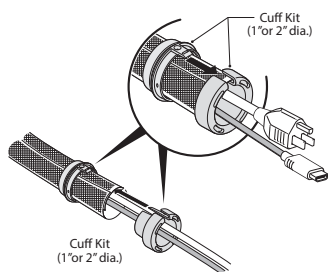

EUAW

Description	Number	Price	
100'	1"(25mm) with 50 Cuffs	Grey EUAW-A001-CG \$1058.96 White EUAW-A001-CW 1058.96 Black EUAW-A001-CB 1058.96	
	1"(25mm) with No Cuffs	Grey EUAW-A001-NG 887.28 White EUAW-A001-NW 887.28 Black EUAW-A001-NB 887.28	
		50'	2"(51mm) with 26 Cuffs
2"(51mm) with No Cuffs			Grey EUAW-5002-NG 887.28 White EUAW-5002-NW 887.28 Black EUAW-5002-NB 887.28

Features

- Includes one bag of 26 - 2"(51mm) Cuffs or one bag of 50 - 1"(25mm) Cuffs and Cord Manager.
- Product is applied to both ends of the Mesh Cord Manager and one end snaps into the Belong Wire Management Tray.

To Order, Specify:

- 1) Product number.

Specification Tips

- The size of the Cuff aligns with the size of the Mesh Cord Wire Manager used.
- The Wire Management Tray can accept both the 1"(25mm) and 2"(51mm) Cuff.
- Available in grey, white or black.
- Loom Insertion Tool Epart 24424401 is recommended for easier installation.

Electrical Components

Belong Power Tap — Horizontal

Power Tap — Horizontal

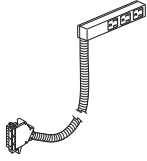

EUET-0030-3M3N
EUET-0030-2M3N
EUET-0030-4M3N



Description	Circuit Access	Number	Price
3-Circuit Conduit Length — Horizontal			
30"(762mm)	1	EUET-0030-3M3N1NL	\$224.65
	2	EUET-0030-3M3N2NL	224.65
	3	EUET-0030-3M3N3NL	224.65
6'(1829mm)	1	EUET-0072-3M3N1NL	\$261.33
	2	EUET-0072-3M3N2NL	261.33
	3	EUET-0072-3M3N3NL	261.33
9'(2743mm)	1	EUET-00A8-3M3N1NL	\$292.77
	2	EUET-00A8-3M3N2NL	292.77
	3	EUET-00A8-3M3N3NL	292.77
4-Circuit, (2+2) Conduit Length — Horizontal			
30"(762mm)	1	EUET-0030-2M3N1NL	\$224.65
	2	EUET-0030-2M3N2NL	224.65
	3	EUET-0030-2M3N3NL	224.65
	4	EUET-0030-2M3N4NL	224.65
6'(1829mm)	1	EUET-0072-2M3N1NL	\$261.33
	2	EUET-0072-2M3N2NL	261.33
	3	EUET-0072-2M3N3NL	261.33
	4	EUET-0072-2M3N4NL	261.33
9'(2743mm)	1	EUET-00A8-2M3N1NL	\$292.77
	2	EUET-00A8-2M3N2NL	292.77
	3	EUET-00A8-2M3N3NL	292.77
	4	EUET-00A8-2M3N4NL	292.77
4-Circuit, (3+1) Conduit Length — Horizontal			
30"(762mm)	1	EUET-0030-4M3N1NL	\$224.65
	2	EUET-0030-4M3N2NL	224.65
	3	EUET-0030-4M3N3NL	224.65
	4	EUET-0030-4M3N4NL	224.65
6'(1829mm)	1	EUET-0072-4M3N1NL	\$261.33
	2	EUET-0072-4M3N2NL	261.33
	3	EUET-0072-4M3N3NL	261.33
	4	EUET-0072-4M3N4NL	261.33
9'(2743mm)	1	EUET-00A8-4M3N1NL	\$292.77
	2	EUET-00A8-4M3N2NL	292.77
	3	EUET-00A8-4M3N3NL	292.77
	4	EUET-00A8-4M3N4NL	292.77

Features

- Includes Power Tap housing with three 15A receptacle outlets (NEMA 5-15R) with 0.375"(10mm) conduit and Power Base connector.
- **Power Base connector is used to connect to PDA.**
- Power Tap housing with receptacles available in charcoal or graphite finish; conduit standard in black only.
- Field installed.

To Order, Specify:

- 1) Product number.
- 2) Trim color.
TR-K Charcoal
TR-J Graphite

Specification Tips:

- Specify conduit length, circuit configuration and circuit access with Power Base connector.
- Specify mounting bracket separately.
 - Fixed Bracket with three patch cord holder mounts Power Tap to edge of worksurface with mounting screws. **Horizontal Power Tap required.**
 - Adjustable bracket mounts Power Tap to edge of worksurface with thumb screws for ease of relocation. **Horizontal Power Tap required.**
- Application may require approval of local authority having jurisdiction (AHJ); ensure compliance before placing orders and installation.
- Do not mix 3-circuit and 6-circuit with 4-circuit components. Do not mix 2+2 and 3+1 components. Components have unique polarity key and color coding (3-circuit=black, 6-circuit=ivory, 2+2=blue and 3+1=green).

Electrical Components

Belong Power Tap — Vertical

Power Tap — Vertical

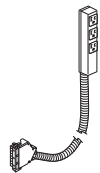

EUET-0030-3M3N
EUET-0030-2M3N
EUET-0030-4M3N



Description	Circuit Access	Number	Price
3-Circuit Conduit Length — Vertical			
30"(762mm)	1	EUET-0030-3M3N1NS	\$224.65
	2	EUET-0030-3M3N2NS	224.65
	3	EUET-0030-3M3N3NS	224.65
6'(1829mm)	1	EUET-0072-3M3N1NS	\$261.33
	2	EUET-0072-3M3N2NS	261.33
	3	EUET-0072-3M3N3NS	261.33
9'(2743mm)	1	EUET-00A8-3M3N1NS	\$292.77
	2	EUET-00A8-3M3N2NS	292.77
	3	EUET-00A8-3M3N3NS	292.77
4-Circuit (2+2) Conduit Length — Vertical			
30"(762mm)	1	EUET-0030-2M3N1NS	\$224.65
	2	EUET-0030-2M3N2NS	224.65
	3	EUET-0030-2M3N3NS	224.65
	4	EUET-0030-2M3N4NS	224.65
6'(1829mm)	1	EUET-0072-2M3N1NS	\$261.33
	2	EUET-0072-2M3N2NS	261.33
	3	EUET-0072-2M3N3NS	261.33
	4	EUET-0072-2M3N4NS	261.33
9'(2743mm)	1	EUET-00A8-2M3N1NS	\$292.77
	2	EUET-00A8-2M3N2NS	292.77
	3	EUET-00A8-2M3N3NS	292.77
	4	EUET-00A8-2M3N4NS	292.77
4-Circuit (3+1) Conduit Length — Vertical			
30"(762mm)	1	EUET-0030-4M3N1NS	\$224.65
	2	EUET-0030-4M3N2NS	224.65
	3	EUET-0030-4M3N3NS	224.65
	4	EUET-0030-4M3N4NS	224.65
6'(1829mm)	1	EUET-0072-4M3N1NS	\$261.33
	2	EUET-0072-4M3N2NS	261.33
	3	EUET-0072-4M3N3NS	261.33
	4	EUET-0072-4M3N4NS	261.33
9'(2743mm)	1	EUET-00A8-4M3N1NS	\$292.77
	2	EUET-00A8-4M3N2NS	292.77
	3	EUET-00A8-4M3N3NS	292.77
	4	EUET-00A8-4M3N4NS	292.77

Features

- Includes Power Tap housing with three 15A receptacle outlets (NEMA 5-15R) with 0.375"(10mm) conduit and Power Base connector.
- **Power Base connector is used to connect to PDA.**
- Power Tap housing with receptacles available in charcoal or graphite finish; conduit standard in black only.
- Field installed.

To Order, Specify:

- 1) Product number.
- 2) Trim color.



TR-K	Charcoal
TR-J	Graphite

Specification Tips:

- Specify conduit length, circuit configuration and circuit access with Power Base connector.
- Specify mounting bracket separately.
 - Fixed Bracket with three patch cord holder mounts Power Tap to edge of worksurface with mounting screws. **Horizontal Power Tap required.**
 - Adjustable bracket mounts Power Tap to edge of worksurface with thumb screws for ease of relocation. **Horizontal Power Tap required.**
- Application may require approval of local authority having jurisdiction (AHJ); ensure compliance before placing orders and installation.
- Do not mix 3-circuit and 6-circuit with 4-circuit components. Do not mix 2+2 and 3+1 components. Components have unique polarity key and color coding (3-circuit=black, 6-circuit=ivory, 2+2=blue and 3+1=green).

Electrical Components

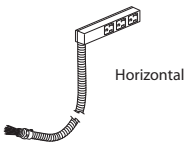
Belong Power Tap — Hardwire and Corded

	Description	Circuit	Number	Price	
Power Tap — Hardwire  Horizontal  Vertical EUET-0030-CM3N 	Hardwire Length — Horizontal				
	30'(762mm)	1	EUET-0030-CM3N1NL	\$224.65	
	6'(1829mm)	1	EUET-0072-CM3N1NL	261.33	
	9'(2743mm)	1	EUET-00A8-CM3N1NL	292.77	
	15'(4572mm)	1	EUET-00J0-CM3N1NL	355.65	
	Hardwire Length — Vertical				
	30'(762mm)	1	EUET-0030-CM3N1NS	\$224.65	
	6'(1829mm)	1	EUET-0072-CM3N1NS	261.33	
	9'(2743mm)	1	EUET-00A8-CM3N1NS	292.77	
	15'(4572mm)	1	EUET-00J0-CM3N1NS	355.65	

Features



- Includes Power Tap with three 15A receptacle outlets (MEMA 5-15) with conduit and conduit fitting.
- Hardwire option for connection to field wired junction box with 0.5"(13mm) knockout.
- Power Tap housing with receptacles available in charcoal or graphite finish; conduit standard in black only.
- Field installed.

To Order, Specify:

- 1) Product number.
- 2) Trim color.
 TR-K Charcoal
 TR-J Graphite

Specification Tips

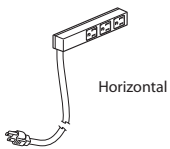
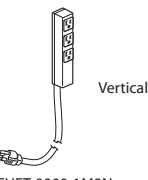
- **For use with 120 volt 60 hertz power source only.**
- **Specify mounting bracket separately.**
 - Fixed Bracket with three patch cord holder mounts Power Tap to edge of worksurface with mounting screws. **Horizontal Power Tap required.**
 - Adjustable bracket mounts Power Tap to edge of worksurface with thumb screws for ease of relocation. **Horizontal Power Tap required.**
 - Under Surface bracket mounts Power Tap under worksurface. **Vertical Power Tap required.**
- Application may require approval of local authority having jurisdiction (AHJ); ensure compliance before placing orders and installation.

	Description	Circuit	Number	Price	
Power Tap — Corded Horizontal and Vertical  Horizontal  Vertical EUET-0000-1M3N 	Corded Length — Horizontal				
	6'(1829mm)	1	EUET-0000-1M3N16L	\$159.12	
	9'(2743mm)	1	EUET-0000-1M3N19L	170.34	
	15'(4572mm)	1	EUET-0000-1M3N1EL	192.78	
	25'(7620mm)	1	EUET-0000-1M3N1YL	230.18	
	Corded Length — Vertical				
	6'(1829mm)	1	EUET-0000-1M3N16S	\$159.12	
	9'(2743mm)	1	EUET-0000-1M3N19S	170.34	
	15'(4572mm)	1	EUET-0000-1M3N1ES	192.78	
	25'(7620mm)	1	EUET-0000-1M3N1YS	230.18	

Features

- Includes Power Tap with three 15A receptacle outlets (MEMA 5-15R) with cord and plug (15A NEMA 5-15-P).
- Power Tap housing with receptacles available in charcoal or graphite finish; cord standard in black only.
- Field installed.

To Order, Specify:

- 1) Product number.
- 2) Trim color.
 TR-K Charcoal
 TR-J Graphite

Specification Tips

- **For use with 120 volt 60 hertz power source only.**
- **Specify mounting bracket separately.**
 - Fixed Bracket with three patch cord holder mounts Power Tap to edge of worksurface with mounting screws. **Horizontal Power Tap required.**
 - Adjustable bracket mounts Power Tap to edge of worksurface with thumb screws for ease of relocation. **Horizontal Power Tap required.**
 - Under Surface bracket mounts Power Tap under worksurface. **Vertical Power Tap required.**
- Application may require approval of local authority having jurisdiction (AHJ); ensure compliance before placing orders and installation.

Electrical Components

Belong Power Tap Brackets

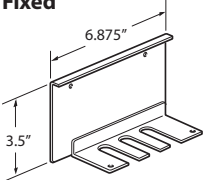
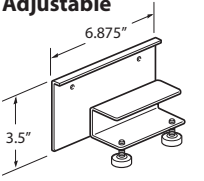
	Description	Number	Trim	
			A	B
Power Tap Bracket — Fixed  ZUAP-0000-PFD	Fixed Features <ul style="list-style-type: none"> Includes one Power Tap mounting bracket and mounting hardware. Fixed Bracket mounts Power Tap to edge of worksurface with mounting screws. Fixed bracket accommodates three patch cords. Horizontal Power Tap required. <hr/> Specification Tips <ul style="list-style-type: none"> Accommodates 1.18" (30mm) thick tops with clear space below. Power Tap applications should be reviewed by local authorities (electrical inspector) prior to ordering due to varying local codes. Not compatible with the Power Tap-Corded shipped prior to July 2013. 	ZUAP-0000-PFD	\$65.52	74.91
Power Tap Bracket — Adjustable  ZUAP-0000-PAN	Adjustable Features <ul style="list-style-type: none"> Includes one Power Tap mounting bracket and mounting hardware. Adjustable bracket mounts Power Tap to back edge of worksurface with thumb screws for ease of relocation. Horizontal Power Tap required. <hr/> Specification Tips <ul style="list-style-type: none"> Accommodates 1.18" (30mm) thick tops with clear space below. Adjustable Power Tap Bracket may interfere with Screen application. Power Tap applications should be reviewed by local authorities (electrical inspector) prior to ordering due to varying local codes. Not compatible with the Power Tap-Corded shipped prior to July 2013. 	ZUAP-0000-PAN	\$82.36	91.75

Electrical Components

Belong Power Tap Brackets

	Description	Number	Trim	
			A	B
Power Tap Bracket — Under Surface	Under Surface — Right-hand	ZUAP-0000-PUR	\$65.52	\$74.91
	Under Surface — Left-hand	ZUAP-0000-PUL	65.52	74.91

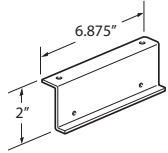

ZUAP-0000-PUR

Features

- Includes one Power Tap mounting bracket and mounting hardware.
- Under Surface bracket mounts Power Tap under worksurface.
- **Vertical Power Tap required.**

To Order, Specify:

- 1) Product number.
- 2) Trim color.

Specification Tips

- **Accommodates 1.18" (30mm) thick tops with clear space below.**
- Under surface bracket may be used on top of worksurface in restricted reach (ADA) applications. Mounting screws will deface top of worksurface.
- Power Tap applications should be reviewed by local authorities (electrical inspector) prior to ordering due to varying local codes.
- **Not compatible with the Power Tap-Corded shipped prior to July 2013.**

Power Tap Bracket with Grommet

Fixed Grommet — Horizontal	ZUAP-0000-PGH	\$147.88	\$157.27
Fixed Grommet — Vertical	ZUAP-0000-PGV	147.88	157.27

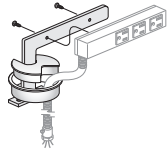

ZUAP-0000-PGH

Features

- Includes one Power Tap bracket, grommet with cover and mounting hardware.
- Horizontal bracket mounts to top through field installed grommet. Horizontal Power Tap required.
- Vertical bracket mounts to top through field installed grommet. Vertical Power Tap required.

To Order, Specify:

- 1) Product number.
- 2) Trim color.

Specification Tips

- **Accommodates 1.18" (30mm) thick tops with clear space below.**
- Application may require approval of local authority having jurisdiction (AHJ); ensure compliance before placing orders and installation.
- Power Tap Bracket with grommet can only be used with 3-Circuit, 4-Circuit and Hardwired power taps.

Electrical Components

Bezel Utility Module

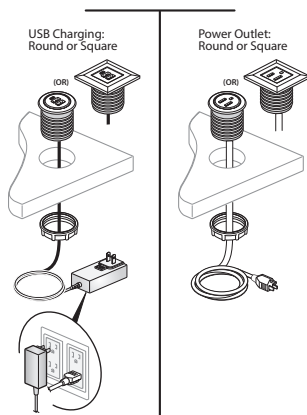

EURT-0072-1100
EURT-0072-1010



Features

- Includes: Either a round or square faced Power Module and mounting hardware.
- For use on surfaces 0.75”(19mm) - 1.44”(37mm) thick.
- Available with either:
 - One power outlet (NEMA 5-15R)
 - One two port USB charger. Consists of two USB outlets with 1000mA of charging power (5 volts) per USB outlet.
 - One data/video jack
- Available in black or supplier white only.

Specification Tips

- For use with 120 volt 60 hertz power source only.
- Power configuration has one cord with plug (NEMA 5-15P).
- USB configuration has one cord with 2”(51mm) x 1”(25mm) x 3”(76mm) voltage transformer plug. Transformer may block adjacent outlets (see illustration).
- Data jacks and AV cables field supplied.
- Data jack adapters accommodate most varieties of field supplied data jacks or separately specified AV cables.
- Requires field cut 1.75”(44mm) hole and field installation.
- Application may require approval of local authority having jurisdiction (AHJ); ensure compliance before placing orders and installing.

To Order, Specify:

1) Product number, including:

1 Shape:

S Square

C Round

2 Color Options:

B Black

W White

Description	Depth	Number	1 2	Price
6' Cord				
Power	1.75”(44mm)	EURT-0072-1100	■ ■	\$120.54
USB		EURT-0072-1010	■ ■	361.66
12' Cord				
Power	1.75”(44mm)	EURT-00E4-1100	■ ■	\$206.65
USB		EURT-00E4-1010	■ ■	447.77

Data Bezel

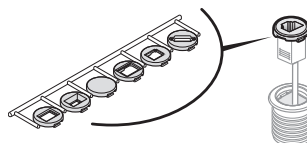

EURT-0000-N001CB
EURT-0000-N001CW

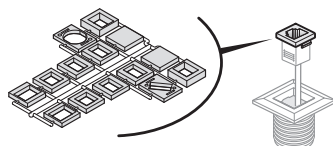

EURT-0000-N001SB
EURT-0000-N001SW

Description

Round

Black EURT-0000-N001CB \$120.54

White EURT-0000-N001CW 120.54

Square

Black EURT-0000-N001SB \$120.54

White EURT-0000-N001SW 120.54

Feature

- Includes one round or square bezel for the Bezel Utility Module.
- Available in black or supplier white only.

To Order, Specify:

1) Product number.
(No finish specification required.)

Electrical Components

Cables

	Length	Description	Color	Number	Price
Cables	HDMI Coupler				
	N/A	HDMI	Black	EUDX-H000-B	\$214.26
	N/A	HDMI	White	EUDX-H000-W	214.26
	VGA Cable				
	120"(3048mm)	VGA	Black	EUDX-V000-B	\$257.12
		VGA	White	EUDX-V000-W	257.12
Audio Cable — 3.5mm					
120"(3048mm)	VGA	Black	EUDX-3000-B	\$ 60.01	
	VGA	White	EUDX-3000-W	60.01	

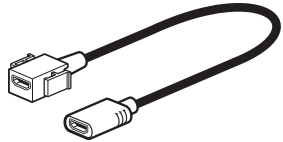

EUDX-H000-B

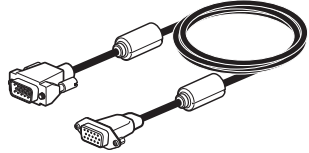

EUDX-V000-B



EUDX-3000-B

Features

- Includes one black HDMI Coupler, one VGA cable or one 3.5mm mini audio cable.
- Installs in an open data port in one of the following products:
 - Flip Top Unit
 - Double Sided Flip Top Unit
 - Quick Connect Power
 - Flush Mount Module
 - Enhanced Power Module
 - Data Bezel

To Order, Specify:

- 1) Product number.
(No finish specification required.)

Specification Tips

- Provides communication between components: i.e. laptop, processor, monitor, etc.
- HDMI transmits digital video signals.
- VGA transmits analog video signals without audio.

Retrofit USB Charging Cable	72"(1829mm)		Black	EUDX-U000-B	\$197.38
			White	EUDX-U000-W	197.38

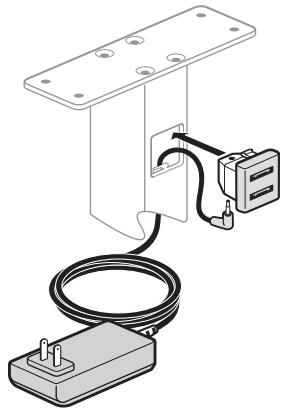

EUDX-U000-B



Features

- Includes one USB charging simplex (with two USB outlets) with 72"(1829mm) cord and power supply.
- Installs in an open data port in one of the following products:
 - Flip Top Unit
 - Double Sided Flip Top Unit
 - Quick Connect Power
 - Flush Mount Module
 - Enhanced Power Module
- USB Charging Port consists of 2 USB outlets. 1,000mA of charging power per USB outlet.

To Order, Specify:

- 1) Product number.
(No finish specification required.)

Electrical Components

Classic Power Module

Width	Depth	Cord Length	Trim Color	Color	Port	Configuration	Number	Price
Corded								
		6'(1829mm)	Black	Black	3	2 Power Receptacles, 1 USB Charging	EUF1-PF0B-21000	\$286.81
					4	3 Power Receptacles, 1 USB Charging	EUF1-PF0B-31000	301.64
		6'(1829mm)	White	White	3	2 Power Receptacles, 1 USB Charging	EUF1-PF0W-21000	\$286.81
					4	3 Power Receptacles, 1 USB Charging	EUF1-PF0W-31000	301.64
		10'(3048mm)	Black	Black	3	2 Power Receptacles, 1 USB Charging	EUF1-PJ0B-21000	\$308.70
					4	3 Power Receptacles, 1 USB Charging	EUF1-PJ0B-31000	323.53
		10'(3048mm)	White	White	3	2 Power Receptacles, 1 USB Charging	EUF1-PJ0W-21000	\$308.70
					4	3 Power Receptacles, 1 USB Charging	EUF1-PJ0W-31000	323.53

Classic Power Module

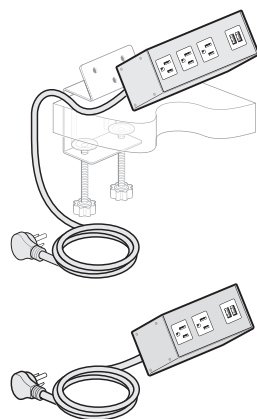

EUF1

Features

- Includes power module with 3 or 4 ports configured with simplex outlets (NEMA-5-15R), USB charging port (with two USB outlets).
- Corded power module with 15 amp - 6'(1829mm) or 10'(3048mm) long cord with plug (NEMA 5-15P).
- USB Charging Port consists of two 5V USB 2.0 style A outlets, each with 10.5W (2.1Amp) charging capacity.
- Attaches to surface with separately specified mounting brackets.
- Color option of black or white front.

Specification Tips

- Not for use with tackboards.
- Configuration and quantity of power and USB ports cannot be modified in the field.
- For use with 120 volt 60 hertz power source only.
- Requires field installation.
- Application may require approval of local authority having jurisdiction (AHJ); ensure compliance before placing orders and installation.
- Separately specified:
 - Mounting Bracket

To Order, Specify:

- 1) Product number.
(No finish specification required.)

Electrical Components

Classic Power Module Brackets

	Description	Number	Price
Classic Power Module Bracket - Angled	Black	EUFB-0000-AB	\$68.80
	White	EUFB-0000-AW	68.80

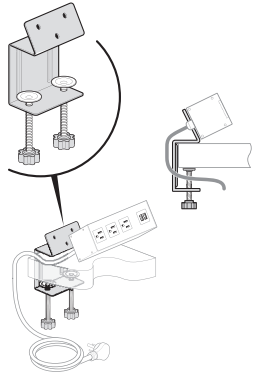

EUFB-0000-AB

Features

- Includes one Classic Power Module mounting bracket and mounting hardware.
- Fixed Bracket mounts Classic Power Module to edge of worksurface with thumb screws for ease of relocation.

Specification Tips

- Accommodates 1.18" (30mm) and 2" (51mm) thick tops with clear space below.
- Classic Power Module applications should be reviewed by local authorities (electrical inspector) prior to ordering due to varying local codes.
- Recommended for use on panel mounted worksurface or freestanding table top.

To Order, Specify:

- 1) Product number.
(No finish specification required.)

Classic Power Module Bracket - Vertical Bracket	Black	EUFB-0000-SB	\$68.80
	White	EUFB-0000-SW	68.80

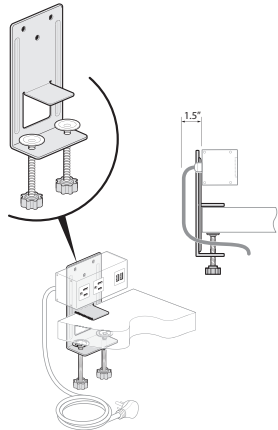

EUFB-0000-SB

Features

- Includes one Classic Power Module mounting bracket and mounting hardware.
- Adjustable bracket mounts Classic Power Module to edge of worksurface with thumb screws for ease of relocation.

Specification Tips

- Accommodates 1.18" (30mm) and 2" (51mm) thick tops with clear space below.
- Adjustable Classic Power Module Bracket may interfere with Screen application.
- Classic Power Module applications should be reviewed by local authorities (electrical inspector) prior to ordering due to varying local codes.
- Recommended for use on freestanding table top.

To Order, Specify:

- 1) Product number.
(No finish specification required.)

Classic Power Module Bracket - Under Surface	Black	EUFB-0000-UB	\$68.80
	White	EUFB-0000-UW	68.80

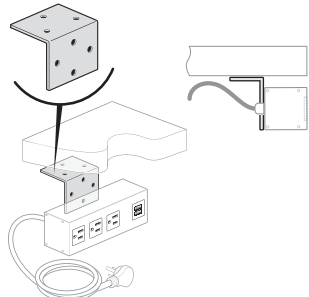

EUFB-0000-UB

Features

- Includes one Classic Power Module mounting bracket and mounting hardware.
- Under Surface bracket mounts Classic Power Module under worksurface with mounting screws.

Specification Tips

- Under surface Classic Power Module bracket may be used on top of worksurface in restricted reach (ADA) applications. Mounting screws will deface top of worksurface.
- Classic Power Module applications should be reviewed by local authorities (electrical inspector) prior to ordering due to varying local codes.

To Order, Specify:

- 1) Product number.
(No finish specification required.)

Electrical Components

Collaborative Power Station

	Color	Number	Price
Collaborative Power Station	Fog/Matte Fog	EUCN-PJ0F-311	\$1386.65
	Storm/Matte Storm	EUCN-PJ0S-311	1386.65
	Black/Matte Black	EUCN-PJ0B-311	1386.65
	Fog/Weathered Aspen Veneer	EUCN-PJ0V-311	1914.00

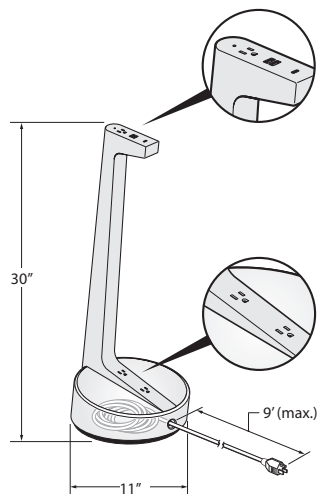

EUCN-PJ



Features

- Includes power module with 5 ports (3 on the top and 2 on the bottom) configured with simplex outlets (NEMA-5-15R) and USB charging port.
- Corded power module with 15 amp - 9'(2743mm) long cord with plug (NEMA 5-15P). Ensure power is within 9'(2743mm) of desired location.
- USB-A provides two 10W charging ports.
- USB-C 18W provides a single 18w USB-C port that can provide a fast charge for mobile phones and tablets.
- Color options:
 - Fog/Matte Fog
 - Storm/Matte Storm
 - Black/Matte Black
 - Fog/Weathered Aspen Veneer

To Order, Specify:

- 1) Product number.
(No finish specification required.)

Specification Tips

- Configuration and quantity of power and data ports cannot be modified in the field.
- For use with 120 volt 60 hertz power source only.
- Requires field installation.
- Application may require approval of local authority having jurisdiction (AHJ); ensure compliance before placing orders and installation.

This page intentionally blank

Electrical Components

Enhanced Power Module — Seamless

Enhanced Power Module — Seamless

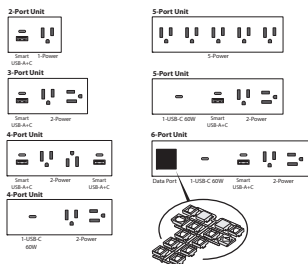
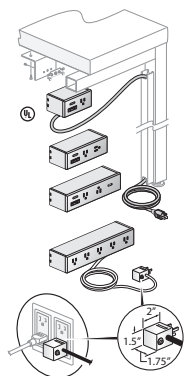

EUS1-PF0B
EUS1-PF0W
EUS1-HLOB
EUS1-HLOW

Features

- Includes power module with 2, 3, 4, 5 or 6 ports configured with simplex outlets (NEMA-5-15R), USB charging port (Smart USB-A+C) or data ports and mounting hardware.
- Power Modules specified with a data port includes a variety of data port adapters and blank covers, which accommodate most varieties of field supplied data/AV Jacks.
- The Smart USB-A+C allows for the 20W to be transferred between the 2 ports. If the USB-A is being used, the full wattage is sent to the USB-A, and the same for the USB-C. If both are being used, the wattage is distributed to each port and the port drawing the most power will receive more watts than the one that is not.
- Corded power module with 15 amp - 6’(1829mm) or 12’(3658mm) long cord with plug (NEMA 5-15P).
- Hardwire power module with 12’(3658mm) flexible galvanized metal conduit with fitting for 0.5”(13mm) knockout and wires for hardwire connection.
- USB-C 60W charging ports not available for hardwire.
- Smart USB-A+C can provide fast charge for a mobile phone and tablets. Occupies one charging port.
- USB-C 60W can charge a computer. Occupies two charging ports.
- Attaches to surface with separately specified mounting brackets.
- Enhanced Power Module Bracket EUDB-0000-B_ for perimeter edge power.
- Color option of black or white plastic front.

Specification Tips

- Configuration and quantity of power and data ports cannot be modified in the field.
- For use with 120 volt 60 hertz power source only.
- Requires field installation.
- Specify AV cables separately.
- Application may require approval of local authority having jurisdiction (AHJ); ensure compliance before placing orders and installation.
- Separately specified:
 - Mounting Bracket
 - Horizontal and Vertical Wire Management

To Order, Specify:

- 1) Product number.
(No finish specification required.)

Electrical Components

Enhanced Power Module — Seamless

Width	Depth	Cord Length	Trim Color	Color	Port	Configuration	Number	Price
Corded								
4"(102mm)	1.875"(48mm)	6'(1829mm)	Black	Black	2	1 Power Receptacles, 1 Data Port	EUS1-PF0B-1010	\$ 504.34
						1 Power Receptacles, 1 Smart USB-A+C Charging	EUS1-PF0B-1100	603.24
						2 Power Receptacles	EUS1-PF0B-2000	504.34
5.5"(140mm)					3	1 Power Receptacles, 1 USB-C 60W Charging	EUS1-PF0B-100001	\$ 863.53
						2 Power Receptacles, 1 Data Port	EUS1-PF0B-2010	590.05
						2 Power Receptacles, 1 Smart USB-A+C Charging	EUS1-PF0B-2100	688.95
						3 Power Receptacles	EUS1-PF0B-3000	590.05
7"(178mm)					4	2 Power Receptacles, 2 Smart USB-A+C Charging	EUS1-PF0B-210010	787.85
						2 Power Receptacles, 1 USB-C 60W Charging	EUS1-PF0B-200001	863.53
						2 Power Receptacles, 1 Data Port, 1 Smart USB-A+C Charging	EUS1-PF0B-201010	688.95
9.5"(241mm)					5	2 Power Receptacles, 1 Smart USB-A+C Charging, 1 USB-C 60W Charging	EUS1-PF0B-210001	\$1048.13
						3 Power Receptacles, 1 Smart USB-A+C Charging, 1 Data Port	EUS1-PF0B-3110	774.65
						3 Power Receptacles, 2 Smart USB-A+C Charging	EUS1-PF0B-3200	873.55
						4 Power Receptacles, 1 Data Port	EUS1-PF0B-4010	675.75
						5 Power Receptacles	EUS1-PF0B-5000	675.75
11"(279mm)					6	2 Power Receptacles, 1 Smart USB-A+C Charging, 1 Data Port, 1 USB-C 60W Charging	EUS1-PF0B-211001	\$1133.83
4"(102mm)	1.875"(48mm)	6'(1829mm)	White	White	2	1 Power Receptacles, 1 Data Port	EUS1-PF0W-1010	\$ 332.93
						1 Power Receptacles, 1 Smart USB-A+C Charging	EUS1-PF0W-1100	431.83
						2 Power Receptacles	EUS1-PF0W-2000	332.93
5.5"(140mm)					3	1 Power Receptacles, 1 USB-C 60W Charging	EUS1-PF0W-100001	\$ 692.12
						2 Power Receptacles, 1 Data Port	EUS1-PF0W-2010	418.64
						2 Power Receptacles, 1 Smart USB-A+C Charging	EUS1-PF0W-2100	517.54
						3 Power Receptacles	EUS1-PF0W-3000	418.64
7"(178mm)					4	2 Power Receptacles, 2 Smart USB-A+C Charging	EUS1-PF0W-210010	616.44
						2 Power Receptacles, 1 USB-C 60W Charging	EUS1-PF0W-200001	692.12
						2 Power Receptacles, 1 Data Port, 1 Smart USB-A+C Charging	EUS1-PF0W-201010	517.54
9.5"(241mm)					5	2 Power Receptacles, 1 Smart USB-A+C Charging, 1 USB-C 60W Charging	EUS1-PF0W-210001	\$ 876.72
						3 Power Receptacles, 1 Smart USB-A+C Charging, 1 Data Port	EUS1-PF0W-3110	603.24
						3 Power Receptacles, 2 Smart USB-A+C Charging	EUS1-PF0W-3200	702.14
						4 Power Receptacles, 1 Data Port	EUS1-PF0W-4010	504.34
						5 Power Receptacles	EUS1-PF0W-5000	504.34
11"(279mm)					6	2 Power Receptacles, 1 Smart USB-A+C Charging, 1 Data Port, 1 USB-C 60W Charging	EUS1-PF0W-211001	\$ 962.42
4"(102mm)	1.875"(48mm)	12'(3658mm)	Black	Black	2	1 Power Receptacles, 1 Data Port	EUS1-PL0B-1010	\$ 584.91
						1 Power Receptacles, 1 Smart USB-A+C Charging	EUS1-PL0B-1100	683.81
						2 Power Receptacles	EUS1-PL0B-2000	584.91
5.5"(140mm)					3	1 Power Receptacles, 1 USB-C 60W Charging	EUS1-PL0B-100001	\$ 944.10
						2 Power Receptacles, 1 Data Port	EUS1-PL0B-2010	670.62
						2 Power Receptacles, 1 Smart USB-A+C Charging	EUS1-PL0B-2100	769.52
						3 Power Receptacles	EUS1-PL0B-3000	670.62
7"(178mm)					4	2 Power Receptacles, 2 Smart USB-A+C Charging	EUS1-PL0B-210010	868.42
						2 Power Receptacles, 1 USB-C 60W Charging	EUS1-PL0B-200001	944.10
						2 Power Receptacles, 1 Data Port, 1 Smart USB-A+C Charging	EUS1-PL0B-201010	769.52
9.5"(241mm)					5	2 Power Receptacles, 1 Smart USB-A+C Charging, 1 USB-C 60W Charging	EUS1-PL0B-210001	\$1128.70
						3 Power Receptacles, 1 Smart USB-A+C Charging, 1 Data Port	EUS1-PL0B-3110	855.22
						3 Power Receptacles, 2 Smart USB-A+C Charging	EUS1-PL0B-3200	954.12
						4 Power Receptacles, 1 Data Port	EUS1-PL0B-4010	756.32
						5 Power Receptacles	EUS1-PL0B-5000	756.32
11"(279mm)					6	2 Power Receptacles, 1 Smart USB-A+C Charging, 1 Data Port, 1 USB-C 60W Charging	EUS1-PL0B-211001	\$1214.40

Electrical Components

Enhanced Power Module — Seamless

Width	Depth	Cord Length	Trim Color	Color	Port	Configuration	Number	Price						
Corded														
4"(102mm)	1.875"(48mm)	12'(3658mm)	White	White	2	1 Power Receptacles, 1 Data Port	EUS1-PL0W-1010	\$ 413.50						
						1 Power Receptacles, 1 Smart USB-A+C Charging	EUS1-PL0W-1100	512.40						
						2 Power Receptacles	EUS1-PL0W-2000	413.50						
5.5"(140mm)					3	1 Power Receptacles, 1 USB-C 60W Charging	EUS1-PL0W-100001	\$ 772.69						
						2 Power Receptacles, 1 Data Port	EUS1-PL0W-2010	499.21						
						2 Power Receptacles, 1 Smart USB-A+C Charging	EUS1-PL0W-2100	598.11						
7"(178mm)					4	3 Power Receptacles	EUS1-PL0W-3000	499.21						
						2 Power Receptacles, 2 Smart USB-A+C Charging	EUS1-PL0W-210010	697.01						
						2 Power Receptacles, 1 USB-C 60W Charging	EUS1-PL0W-200001	772.69						
9.5"(241mm)					5	2 Power Receptacles, 1 Data Port, 1 Smart USB-A+C Charging	EUS1-PL0W-201010	598.11						
						2 Power Receptacles, 1 Smart USB-A+C Charging, 1 USB-C 60W Charging	EUS1-PL0W-210001	\$ 957.29						
						3 Power Receptacles, 1 Smart USB-A+C Charging, 1 Data Port	EUS1-PL0W-3110	683.81						
11"(279mm)					6	3 Power Receptacles, 2 USB-A+C Charging	EUS1-PL0W-3200	782.71						
						4 Power Receptacles, 1 Data Port	EUS1-PL0W-4010	584.91						
						5 Power Receptacles	EUS1-PL0W-5000	584.91						
11"(279mm)					6	2 Power Receptacles, 1 Smart USB-A+C Charging, 1 Data Port, 1 USB-C 60W Charging	EUS1-PL0W-211001	1042.99						
						Hardwire								
						4"(102mm)	1.875"(48mm)	12'(3658mm)	Black	Black	2	1 Power Receptacles, 1 Data Port	EUS1-HL0B-1010	\$ 685.91
1 Power Receptacles, 1 Smart USB-A+C Charging	EUS1-HL0B-1100	784.81												
2 Power Receptacles	EUS1-HL0B-2000	685.91												
5.5"(140mm)					3	2 Power Receptacles, 1 Data Port	EUS1-HL0B-2010	\$ 771.62						
						2 Power Receptacles, 1 Smart USB-A+C Charging	EUS1-HL0B-2100	870.52						
						3 Power Receptacles	EUS1-HL0B-3000	771.62						
7"(178mm)					4	2 Power Receptacles, 1 Smart USB-A+C Charging, 1 Data Port	EUS1-HL0B-2110	870.52						
						2 Power Receptacles, 2 Smart USB-A+C Charging	EUS1-HL0B-2200	\$ 969.42						
						3 Power Receptacles, 1 Smart USB-A+C Charging, 1 Data Port	EUS1-HL0B-3110	\$ 956.22						
9.5"(241mm)					5	3 Power Receptacles, 2 Smart USB-A+C Charging	EUS1-HL0B-3200	1055.12						
						4 Power Receptacles, 1 Data Port	EUS1-HL0B-4010	857.32						
						5 Power Receptacles	EUS1-HL0B-5000	857.32						
4"(102mm)	1.875"(48mm)	12'(3658mm)	White	White	2	1 Power Receptacles, 1 Data Port	EUS1-HL0W-1010	\$ 514.50						
						1 Power Receptacles, 1 Smart USB-A+C Charging	EUS1-HL0W-1100	613.40						
						2 Power Receptacles	EUS1-HL0W-2000	514.50						
5.5"(140mm)					3	2 Power Receptacles, 1 Data Port	EUS1-HL0W-2010	\$ 600.21						
						2 Power Receptacles, 1 Smart USB-A+C Charging	EUS1-HL0W-2100	699.11						
						3 Power Receptacles	EUS1-HL0W-3000	600.21						
7"(178mm)					4	2 Power Receptacles, 1 Smart USB-A+C Charging, 1 Data Port	EUS1-HL0W-2110	699.11						
						2 Power Receptacles, 2 Smart USB-A+C Charging	EUS1-HL0W-2200	\$ 798.01						
						3 Power Receptacles, 1 Smart USB-A+C Charging, 1 Data Port	EUS1-HL0W-3110	\$ 784.81						
9.5"(241mm)					5	3 Power Receptacles, 2 Smart USB-A+C Charging	EUS1-HL0W-3200	883.71						
						4 Power Receptacles, 1 Data Port	EUS1-HL0W-4010	685.91						
						5 Power Receptacles	EUS1-HL0W-5000	685.91						

This page intentionally blank

Electrical Components

Enhanced Power Module — Corded

3-Port:

- (2) Power
- (1) Smart USB-A+C



EUD1-PF0B-2010

4-Port:

- (2) Power
- (1) Smart USB-A+C
- (1) Data



EUD1-PF0B-2110

6-Port:

- (2) Power
- (1) Smart USB-A+C
- (1) Data
- (1) Cable Bay

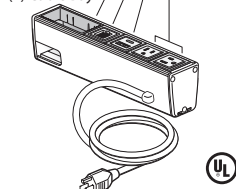

EUD1-PF0B-2112

4-Port:

- (4) Power

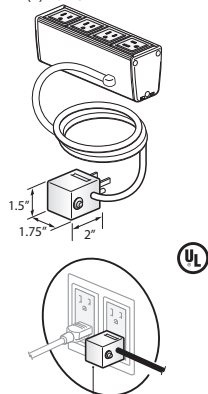

NOTE:
Always Circuit Breaker Plug
when more than 3
power outlets specified.

EUD1-PF0B-4000

Features

- Includes power module with 3, 4 or 6 ports that can be configured with simplex outlets (NEMA-5-15R), USB charging port (Smart USB-A+C), data ports or cable bay(s) that can accept up to two pull out data/AV cables and mounting hardware.
- Data port accommodate most varieties of field supplied data/AV jacks.
- Attaches to surface with use of separately specified mounting brackets.
- Corded power module available with 15 amp - 6'(1829mm) or 12'(3658mm) long cord with plug (NEMA 5-15P).
- The Smart USB-A+C allows for the 20W to be transferred between the 2 ports. If the USB-A is being used, the full wattage is sent to the USB-A, and the same for the USB-C. If both are being used, the wattage is distributed to each port and the port drawing the most power will receive more watts than the one that is not.
- Color option of black anodized housing with black receptacles or clear anodized housing with white receptacles.

To Order, Specify:

- 1) Product number.
(No finish specification required.)

Specification Tips

- **Configuration and quantity of power and data ports cannot be modified in the field.**
- **For use with 120 volt 60 hertz power source only.**
- Separately specify attachment hardware for desired application.
- Requires field installation.
- Specify AV cables separately.
- Cable Bay requires cables less than 0.3"(7.6mm) diameter.
- Application may require approval of local authority having jurisdiction (AHJ); ensure compliance before placing orders and installation.

Electrical Components

Enhanced Power Module — Corded

Top Width	Top Depth	Cord Length	Housing Color	Port Color	Port	Configuration	Number	Price
5" (127mm)	3" (76mm)	6' (1829mm)	Black Anodized	Black	3	1 Power Receptacle, 1 Cable Bay	EUD1-PF0B-1002	\$ 579.99
						1 Power Receptacle, 2 Data Ports	EUD1-PF0B-1020	579.99
						1 Power Receptacle, 1 Data Port, 1 Smart USB-A+C Charging	EUD1-PF0B-1110	678.89
						1 Power Receptacle, 2 Smart USB-A+C Charging	EUD1-PF0B-1200	777.79
						2 Power Receptacles, 1 Data Port	EUD1-PF0B-2010	579.99
						2 Power Receptacles, 1 Smart USB-A+C Charging	EUD1-PF0B-2100	678.89
6.5" (165mm)	3" (76mm)				4	1 Power Receptacle, 1 Data Port, 1 Cable Bay	EUD1-PF0B-1012	\$ 579.99
						1 Power Receptacle, 3 Data Ports	EUD1-PF0B-1030	579.99
						1 Power Receptacle, 1 Smart USB-A+C Charging, 1 Cable Bay	EUD1-PF0B-1102	678.89
						1 Power Receptacle, 3 Smart USB-A+C Charging	EUD1-PF0B-1300	876.69
						2 Power Receptacles, 1 Cable Bay	EUD1-PF0B-2002	579.99
						2 Power Receptacles, 2 Data Ports	EUD1-PF0B-2020	579.99
						2 Power Receptacles, 1 Smart USB-A+C Charging, 1 Data Port	EUD1-PF0B-2110	678.89
						2 Power Receptacles, 2 Smart USB-A+C Charging	EUD1-PF0B-2200	777.79
						3 Power Receptacles, 1 Data Port	EUD1-PF0B-3010	579.99
						3 Power Receptacles, 1 Smart USB-A+C Charging	EUD1-PF0B-3100	678.89
						4 Power Receptacles	EUD1-PF0B-4000	579.99
						9.5" (241mm)	3" (76mm)	
1 Power Receptacle, 1 Smart USB-A+C Charging, 2 Data Ports, 1 Cable Bay	EUD1-PF0B-1122	764.59						
1 Power Receptacle, 1 Smart USB-A+C Charging, 4 Data Ports	EUD1-PF0B-1140	764.59						
1 Power Receptacle, 2 Smart USB-A+C Charging, 1 Data Port, 1 Cable Bay	EUD1-PF0B-1212	863.49						
1 Power Receptacle, 2 Smart USB-A+C Charging, 3 Data Ports	EUD1-PF0B-1230	863.49						
1 Power Receptacle, 3 Smart USB-A+C Charging, 1 Cable Bay	EUD1-PF0B-1302	962.39						
1 Power Receptacle, 3 Smart USB-A+C Charging, 2 Data Ports	EUD1-PF0B-1320	962.39						
1 Power Receptacle, 4 Smart USB-A+C Charging, 1 Data Port	EUD1-PF0B-1410	1061.29						
2 Power Receptacles, 2 Cable Bays	EUD1-PF0B-2004	665.69						
2 Power Receptacles, 2 Data Ports, 1 Cable Bay	EUD1-PF0B-2022	665.69						
2 Power Receptacles, 4 Data Ports	EUD1-PF0B-2040	665.69						
2 Power Receptacles, 1 Smart USB-A+C Charging, 1 Data Port, 1 Cable Bay	EUD1-PF0B-2112	764.59						
2 Power Receptacles, 1 Smart USB-A+C Charging, 3 Data Ports	EUD1-PF0B-2130	764.59						
2 Power Receptacles, 2 Smart USB-A+C Charging, 1 Cable Bay	EUD1-PF0B-2202	863.49						
2 Power Receptacles, 2 Smart USB-A+C Charging, 2 Data Ports	EUD1-PF0B-2220	863.49						
2 Power Receptacles, 3 Smart USB-A+C Charging, 1 Data Port	EUD1-PF0B-2310	962.39						
2 Power Receptacles, 4 Smart USB-A+C Charging	EUD1-PF0B-2400	1061.29						
3 Power Receptacles, 3 Data Ports	EUD1-PF0B-3030	665.69						
3 Power Receptacles, 1 Smart USB-A+C Charging, 1 Cable Bay	EUD1-PF0B-3102	764.59						
3 Power Receptacles, 1 Smart USB-A+C Charging, 2 Data Ports	EUD1-PF0B-3120	764.59						
3 Power Receptacles, 2 Smart USB-A+C Charging, 1 Data Port	EUD1-PF0B-3210	863.49						
3 Power Receptacles, 3 Smart USB-A+C Charging	EUD1-PF0B-3300	962.39						
4 Power Receptacles, 1 Cable Bay	EUD1-PF0B-4002	665.69						
4 Power Receptacles, 2 Data Ports	EUD1-PF0B-4020	665.69						
4 Power Receptacles, 1 Smart USB-A+C Charging, 1 Data Port	EUD1-PF0B-4110	764.59						
4 Power Receptacles, 2 Smart USB-A+C Charging	EUD1-PF0B-4200	863.49						
5 Power Receptacles, 1 Data Port	EUD1-PF0B-5010	665.69						
5 Power Receptacles, 1 Smart USB-A+C Charging	EUD1-PF0B-5100	764.59						
6 Power Receptacles	EUD1-PF0B-6000	665.69						

Electrical Components

Enhanced Power Module — Corded

Top Width	Top Depth	Cord Length	Housing Color	Port Color	Port	Configuration	Number	Price	
9.5" (241mm)	3" (76mm)	6' (1829mm)	Clear Anodized	White	3	1 Power Receptacle, 1 Cable Bay	EUD1-PF0W-1002	\$408.58	
						1 Power Receptacle, 2 Data Ports	EUD1-PF0W-1020	408.58	
						1 Power Receptacle, 1 Data Port, 1 Smart USB-A+C Charging	EUD1-PF0W-1110	507.48	
					1 Power Receptacle, 2 Smart USB-A+C Charging	EUD1-PF0W-1200	606.38		
					2 Power Receptacles, 1 Data Port	EUD1-PF0W-2010	408.58		
					2 Power Receptacles, 1 Smart USB-A+C Charging	EUD1-PF0W-2100	507.48		
					3 Power Receptacles	EUD1-PF0W-3000	408.58		
					4	1 Power Receptacle, 1 Data Port, 1 Cable Bay	EUD1-PF0W-1012	\$408.58	
						1 Power Receptacle, 3 Data Ports	EUD1-PF0W-1030	408.58	
						1 Power Receptacle, 1 Smart USB-A+C Charging, 1 Cable Bay	EUD1-PF0W-1102	507.48	
						1 Power Receptacle, 3 Smart USB-A+C Charging	EUD1-PF0W-1300	705.28	
						2 Power Receptacles, 1 Cable Bay	EUD1-PF0W-2002	408.58	
						2 Power Receptacles, 2 Data Ports	EUD1-PF0W-2020	408.58	
						2 Power Receptacles, 1 Smart USB-A+C Charging, 1 Data Port	EUD1-PF0W-2110	507.48	
						2 Power Receptacles, 2 Smart USB-A+C Charging	EUD1-PF0W-2200	606.38	
						3 Power Receptacles, 1 Data Port	EUD1-PF0W-3010	408.58	
						3 Power Receptacles, 1 Smart USB-A+C Charging	EUD1-PF0W-3100	507.48	
						4 Power Receptacles	EUD1-PF0W-4000	408.58	
						6	1 Power Receptacle, 1 Smart USB-A+C Charging, 2 Cable Bays	EUD1-PF0W-1104	\$593.18
							1 Power Receptacle, 1 Smart USB-A+C Charging, 2 Data Ports, 1 Cable Bay	EUD1-PF0W-1122	593.18
							1 Power Receptacle, 1 Smart USB-A+C Charging, 4 Data Ports	EUD1-PF0W-1140	593.18
							1 Power Receptacle, 2 Smart USB-A+C Charging, 1 Data Port, 1 Cable Bay	EUD1-PF0W-1212	692.08
					1 Power Receptacle, 2 Smart USB-A+C Charging, 3 Data Ports		EUD1-PF0W-1230	692.08	
					1 Power Receptacle, 3 Smart USB-A+C Charging, 1 Cable Bay		EUD1-PF0W-1302	790.98	
					1 Power Receptacle, 3 Smart USB-A+C Charging, 2 Data Ports		EUD1-PF0W-1320	790.98	
					1 Power Receptacle, 4 Smart USB-A+C Charging, 1 Data Port		EUD1-PF0W-1410	889.88	
					2 Power Receptacles, 2 Cable Bays		EUD1-PF0W-2004	494.28	
					2 Power Receptacles, 2 Data Ports, 1 Cable Bay		EUD1-PF0W-2022	494.28	
					2 Power Receptacles, 4 Data Ports		EUD1-PF0W-2040	494.28	
					2 Power Receptacles, 1 Smart USB-A+C Charging, 1 Data Port, 1 Cable Bay		EUD1-PF0W-2112	593.18	
2 Power Receptacles, 1 Smart USB-A+C Charging, 3 Data Ports	EUD1-PF0W-2130	593.18							
2 Power Receptacles, 2 Smart USB-A+C Charging, 1 Cable Bay	EUD1-PF0W-2202	692.08							
2 Power Receptacles, 2 Smart USB-A+C Charging, 2 Data Ports	EUD1-PF0W-2220	692.08							
2 Power Receptacles, 3 Smart USB-A+C Charging, 1 Data Port	EUD1-PF0W-2310	790.98							
2 Power Receptacles, 4 Smart USB-A+C Charging	EUD1-PF0W-2400	889.88							
3 Power Receptacles, 3 Data Ports	EUD1-PF0W-3030	494.28							
3 Power Receptacles, 1 Smart USB-A+C Charging, 1 Cable Bay	EUD1-PF0W-3102	593.18							
3 Power Receptacles, 1 Smart USB-A+C Charging, 2 Data Ports	EUD1-PF0W-3120	593.18							
3 Power Receptacles, 2 Smart USB-A+C Charging, 1 Data Port	EUD1-PF0W-3210	692.08							
3 Power Receptacles, 3 Smart USB-A+C Charging	EUD1-PF0W-3300	790.98							
4 Power Receptacles, 1 Cable Bay	EUD1-PF0W-4002	494.28							
4 Power Receptacles, 2 Data Ports	EUD1-PF0W-4020	494.28							
4 Power Receptacles, 1 Smart USB-A+C Charging, 1 Data Port	EUD1-PF0W-4110	593.18							
4 Power Receptacles, 2 Smart USB-A+C Charging	EUD1-PF0W-4200	692.08							
5 Power Receptacles, 1 Data Port	EUD1-PF0W-5010	494.28							
5 Power Receptacles, 1 Smart USB-A+C Charging	EUD1-PF0W-5100	593.18							
6 Power Receptacles	EUD1-PF0W-6000	494.28							

Electrical Components

Enhanced Power Module — Corded

Top Width	Top Depth	Cord Length	Housing Color	Port Color	Port	Configuration	Number	Price	
9.5" (241mm)	3" (76mm)	12' (3658mm)	Black Anodized	Black	3	1 Power Receptacle, 1 Cable Bay	EUD1-PL0B-1002	\$ 660.56	
						1 Power Receptacle, 2 Data Ports	EUD1-PL0B-1020	660.56	
						1 Power Receptacle, 1 Data Port, 1 Smart USB-A+C Charging	EUD1-PL0B-1110	759.46	
					1 Power Receptacle, 2 Smart USB-A+C Charging	EUD1-PL0B-1200	858.36		
					2 Power Receptacles, 1 Data Port	EUD1-PL0B-2010	660.56		
					2 Power Receptacles, 1 Smart USB-A+C Charging	EUD1-PL0B-2100	759.46		
					3 Power Receptacles	EUD1-PL0B-3000	660.56		
					4	1 Power Receptacle, 1 Data Port, 1 Cable Bay	EUD1-PL0B-1012	\$ 660.56	
						1 Power Receptacle, 3 Data Ports	EUD1-PL0B-1030	660.56	
						1 Power Receptacle, 1 Smart USB-A+C Charging, 1 Cable Bay	EUD1-PL0B-1102	759.46	
						1 Power Receptacle, 3 Smart USB-A+C Charging	EUD1-PL0B-1300	957.26	
						2 Power Receptacles, 1 Cable Bay	EUD1-PL0B-2002	660.56	
						2 Power Receptacles, 2 Data Ports	EUD1-PL0B-2020	660.56	
						2 Power Receptacles, 1 Smart USB-A+C Charging, 1 Data Port	EUD1-PL0B-2110	759.46	
						2 Power Receptacles, 2 Smart USB-A+C Charging	EUD1-PL0B-2200	858.36	
						3 Power Receptacles, 1 Data Port	EUD1-PL0B-3010	660.56	
						3 Power Receptacles, 1 Smart USB-A+C Charging	EUD1-PL0B-3100	759.46	
						4 Power Receptacles	EUD1-PL0B-4000	660.56	
						6	1 Power Receptacle, 1 Smart USB-A+C Charging, 2 Cable Bays	EUD1-PL0B-1104	\$ 845.16
							1 Power Receptacle, 1 Smart USB-A+C Charging, 2 Data Ports, 1 Cable Bay	EUD1-PL0B-1122	845.16
							1 Power Receptacle, 1 Smart USB-A+C Charging, 4 Data Ports	EUD1-PL0B-1140	845.16
							1 Power Receptacle, 2 Smart USB-A+C Charging, 1 Data Port, 1 Cable Bay	EUD1-PL0B-1212	944.06
					1 Power Receptacle, 2 Smart USB-A+C Charging, 3 Data Ports		EUD1-PL0B-1230	944.06	
					1 Power Receptacle, 3 Smart USB-A+C Charging, 1 Cable Bay		EUD1-PL0B-1302	1042.96	
					1 Power Receptacle, 3 Smart USB-A+C Charging, 2 Data Ports		EUD1-PL0B-1320	1042.96	
					1 Power Receptacle, 4 Smart USB-A+C Charging, 1 Data Port		EUD1-PL0B-1410	1141.86	
					2 Power Receptacles, 2 Cable Bays		EUD1-PL0B-2004	746.26	
					2 Power Receptacles, 2 Data Ports, 1 Cable Bay		EUD1-PL0B-2022	746.26	
					2 Power Receptacles, 4 Data Ports		EUD1-PL0B-2040	746.26	
					2 Power Receptacles, 1 Smart USB-A+C Charging, 1 Data Port, 1 Cable Bay		EUD1-PL0B-2112	845.16	
					2 Power Receptacles, 1 Smart USB-A+C Charging, 3 Data Ports		EUD1-PL0B-2130	845.16	
					2 Power Receptacles, 2 Smart USB-A+C Charging, 1 Cable Bay		EUD1-PL0B-2202	944.06	
					2 Power Receptacles, 2 Smart USB-A+C Charging, 2 Data Ports		EUD1-PL0B-2220	944.06	
2 Power Receptacles, 3 Smart USB-A+C Charging, 1 Data Port	EUD1-PL0B-2310	1042.96							
2 Power Receptacles, 4 Smart USB-A+C Charging	EUD1-PL0B-2400	1141.86							
3 Power Receptacles, 3 Data Ports	EUD1-PL0B-3030	746.26							
3 Power Receptacles, 1 Smart USB-A+C Charging, 1 Cable Bay	EUD1-PL0B-3102	845.16							
3 Power Receptacles, 1 Smart USB-A+C Charging, 2 Data Ports	EUD1-PL0B-3120	845.16							
3 Power Receptacles, 2 Smart USB-A+C Charging, 1 Data Port	EUD1-PL0B-3210	944.06							
3 Power Receptacles, 3 Smart USB-A+C Charging	EUD1-PL0B-3300	1042.96							
4 Power Receptacles, 1 Cable Bay	EUD1-PL0B-4002	746.26							
4 Power Receptacles, 2 Data Ports	EUD1-PL0B-4020	746.26							
4 Power Receptacles, 1 Smart USB-A+C Charging, 1 Data Port	EUD1-PL0B-4110	845.16							
4 Power Receptacles, 2 Smart USB-A+C Charging	EUD1-PL0B-4200	944.06							
5 Power Receptacles, 1 Data Port	EUD1-PL0B-5010	746.26							
5 Power Receptacles, 1 Smart USB-A+C Charging	EUD1-PL0B-5100	845.16							
6 Power Receptacles	EUD1-PL0B-6000	746.26							

Electrical Components

Enhanced Power Module — Corded

Top Width	Top Depth	Cord Length	Housing Color	Port Color	Port	Configuration	Number	Price	
9.5" (241mm)	3" (76mm)	12' (3658mm)	Clear Anodized	White	3	1 Power Receptacle, 1 Cable Bay	EUD1-PL0W-1002	\$489.15	
						1 Power Receptacle, 2 Data Ports	EUD1-PL0W-1020	489.15	
						1 Power Receptacle, 1 Data Port, 1 Smart USB-A+C Charging	EUD1-PL0W-1110	588.05	
						1 Power Receptacle, 2 Smart USB-A+C Charging	EUD1-PL0W-1200	686.95	
						2 Power Receptacles, 1 Data Port	EUD1-PL0W-2010	489.15	
						2 Power Receptacles, 1 Smart USB-A+C Charging	EUD1-PL0W-2100	588.05	
						3 Power Receptacles	EUD1-PL0W-3000	489.15	
						4	1 Power Receptacle, 1 Data Port, 1 Cable Bay	EUD1-PL0W-1012	\$489.15
							1 Power Receptacle, 3 Data Ports	EUD1-PL0W-1030	489.15
							1 Power Receptacle, 1 Smart USB-A+C Charging, 1 Cable Bay	EUD1-PL0W-1102	588.05
							1 Power Receptacle, 3 Smart USB-A+C Charging	EUD1-PL0W-1300	785.85
							2 Power Receptacles, 1 Cable Bay	EUD1-PL0W-2002	489.15
							2 Power Receptacles, 2 Data Ports	EUD1-PL0W-2020	489.15
							2 Power Receptacles, 1 Smart USB-A+C Charging, 1 Data Port	EUD1-PL0W-2110	588.05
							2 Power Receptacles, 2 Smart USB-A+C Charging	EUD1-PL0W-2200	686.95
							3 Power Receptacles, 1 Data Port	EUD1-PL0W-3010	489.15
							3 Power Receptacles, 1 Smart USB-A+C Charging	EUD1-PL0W-3100	588.05
							4 Power Receptacles	EUD1-PL0W-4000	489.15
							6	1 Power Receptacle, 1 Smart USB-A+C Charging, 2 Cable Bays	EUD1-PL0W-1104
						1 Power Receptacle, 1 Smart USB-A+C Charging, 2 Data Ports, 1 Cable Bay		EUD1-PL0W-1122	673.75
						1 Power Receptacle, 1 Smart USB-A+C Charging, 4 Data Ports		EUD1-PL0W-1140	673.75
						1 Power Receptacle, 2 Smart USB-A+C Charging, 1 Data Port, 1 Cable Bay		EUD1-PL0W-1212	772.65
						1 Power Receptacle, 2 Smart USB-A+C Charging, 3 Data Ports		EUD1-PL0W-1230	772.65
						1 Power Receptacle, 3 Smart USB-A+C Charging, 1 Cable Bay		EUD1-PL0W-1302	871.55
						1 Power Receptacle, 3 Smart USB-A+C Charging, 2 Data Ports		EUD1-PL0W-1320	871.55
						1 Power Receptacle, 4 Smart USB-A+C Charging, 1 Data Port		EUD1-PL0W-1410	970.45
						2 Power Receptacles, 2 Cable Bays		EUD1-PL0W-2004	574.85
						2 Power Receptacles, 2 Data Ports, 1 Cable Bay		EUD1-PL0W-2022	574.85
						2 Power Receptacles, 4 Data Ports		EUD1-PL0W-2040	574.85
						2 Power Receptacles, 1 Smart USB-A+C Charging, 1 Data Port, 1 Cable Bay		EUD1-PL0W-2112	673.75
2 Power Receptacles, 1 Smart USB-A+C Charging, 3 Data Ports	EUD1-PL0W-2130	673.75							
2 Power Receptacles, 2 Smart USB-A+C Charging, 1 Cable Bay	EUD1-PL0W-2202	772.65							
2 Power Receptacles, 2 Smart USB-A+C Charging, 2 Data Ports	EUD1-PL0W-2220	772.65							
2 Power Receptacles, 3 Smart USB-A+C Charging, 1 Data Port	EUD1-PL0W-2310	871.55							
2 Power Receptacles, 4 Smart USB-A+C Charging	EUD1-PL0W-2400	970.45							
3 Power Receptacles, 3 Data Ports	EUD1-PL0W-3030	574.85							
3 Power Receptacles, 1 Smart USB-A+C Charging, 1 Cable Bay	EUD1-PL0W-3102	673.75							
3 Power Receptacles, 1 Smart USB-A+C Charging, 2 Data Ports	EUD1-PL0W-3120	673.75							
3 Power Receptacles, 2 Smart USB-A+C Charging, 1 Data Port	EUD1-PL0W-3210	772.65							
3 Power Receptacles, 3 Smart USB-A+C Charging	EUD1-PL0W-3300	871.55							
4 Power Receptacles, 1 Cable Bay	EUD1-PL0W-4002	574.85							
4 Power Receptacles, 2 Data Ports	EUD1-PL0W-4020	574.85							
4 Power Receptacles, 1 Smart USB-A+C Charging, 1 Data Port	EUD1-PL0W-4110	673.75							
4 Power Receptacles, 2 Smart USB-A+C Charging	EUD1-PL0W-4200	772.65							
5 Power Receptacles, 1 Data Port	EUD1-PL0W-5010	574.85							
5 Power Receptacles, 1 Smart USB-A+C Charging	EUD1-PL0W-5100	673.75							
6 Power Receptacles	EUD1-PL0W-6000	574.85							

This page intentionally blank

Electrical Components

Enhanced Power Module — Hardwire

3-Port:

- (2) Power
- (1) Smart USB-A+C

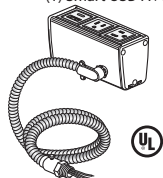

Hard Wired

EUD1-HF0B-2010

4-Port:

- (2) Power
- (1) Smart USB-A+C
- (1) Data

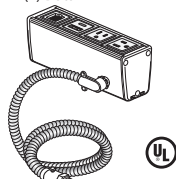

Hard Wired

EUD1-HF0B-2110

6-Port:

- (2) Power
- (1) Smart USB-A+C
- (1) Data
- (1) Cable Bay

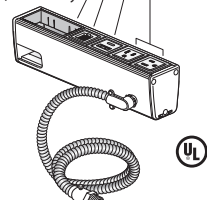

Hard Wired

EUD1-HF0B-2112

Features

- Includes power module with 3, 4 or 6 ports that can be configured with simplex outlets (NEMA-5-15R), USB charging port (Smart USB-A+C), data ports or cable bay(s) that can accept up to two pull out data/AV cables and mounting hardware.
- Data port accommodate most varieties of field supplied data/AV jacks.
- Attaches to surface with use of separately specified mounting brackets.
- Hardwired power module with 6’(1829mm) or 12’(3658mm) long flexible metal conduit feed, 0.5”(13mm) conduit fitting and wires for hardwire connection.
- The Smart USB-A+C allows for the 20W to be transferred between the 2 ports. If the USB-A is being used, the full wattage is sent to the USB-A, and the same for the USB-C. If both are being used, the wattage is distributed to each port and the port drawing the most power will receive more watts than the one that is not.
- Color option of black anodized housing with black receptacles or clear anodized housing with white receptacles.

To Order, Specify:

- 1) Product number.
(No finish specification required.)

Specification Tips

- **Configuration and quantity of power and data ports cannot be modified in the field.**
- **For use with 120 volt 60 hertz power source only.**
- Separately specify attachment hardware for desired application.
- Requires field installation.
- Specify AV cables separately.
- Cable Bay requires cables less than 0.3”(7.6mm) diameter.
- Application may require approval of local authority having jurisdiction (AHJ); ensure compliance before placing orders and installation.

Electrical Components

Enhanced Power Module — Hardwire

Top Width	Top Depth	Conduit Length	Housing Color	Port Color	Port	Configuration	Number	Price						
5" (127mm)	3" (76mm)	6' (1829mm)	Black Anodized	Black	3	1 Power Receptacle, 1 Cable Bay	EUD1-HF0B-1002	\$ 680.99						
						1 Power Receptacle, 2 Data Ports	EUD1-HF0B-1020	680.99						
						1 Power Receptacle, 1 Data Port, 1 Smart USB-A+C Charging	EUD1-HF0B-1110	779.89						
						1 Power Receptacle, 2 Smart USB-A+C Charging	EUD1-HF0B-1200	878.79						
						2 Power Receptacles, 1 Data Port	EUD1-HF0B-2010	680.99						
						2 Power Receptacles, 1 Smart USB-A+C Charging	EUD1-HF0B-2100	779.89						
						3 Power Receptacles	EUD1-HF0B-3000	680.99						
6.5" (165mm)	3" (76mm)				4	1 Power Receptacle, 1 Data Port, 1 Cable Bay	EUD1-HF0B-1012	\$ 680.99						
						1 Power Receptacle, 3 Data Ports	EUD1-HF0B-1030	680.99						
						1 Power Receptacle, 1 Smart USB-A+C Charging, 1 Cable Bay	EUD1-HF0B-1102	779.89						
						1 Power Receptacle, 3 Smart USB-A+C Charging	EUD1-HF0B-1300	977.69						
						2 Power Receptacles, 1 Cable Bay	EUD1-HF0B-2002	680.99						
						2 Power Receptacles, 2 Data Ports	EUD1-HF0B-2020	680.99						
						2 Power Receptacles, 1 Smart USB-A+C Charging, 1 Data Port	EUD1-HF0B-2110	779.89						
						2 Power Receptacles, 2 Smart USB-A+C Charging	EUD1-HF0B-2200	878.79						
						3 Power Receptacles, 1 Data Port	EUD1-HF0B-3010	680.99						
						3 Power Receptacles, 1 Smart USB-A+C Charging	EUD1-HF0B-3100	779.89						
						4 Power Receptacles	EUD1-HF0B-4000	680.99						
						9.5" (241mm)	3" (76mm)				6	1 Power Receptacle, 1 Smart USB-A+C Charging, 2 Cable Bays	EUD1-HF0B-1104	\$ 865.59
												1 Power Receptacle, 1 Smart USB-A+C Charging, 2 Data Ports, 1 Cable Bay	EUD1-HF0B-1122	865.59
1 Power Receptacle, 1 Smart USB-A+C Charging, 4 Data Ports	EUD1-HF0B-1140	865.59												
1 Power Receptacle, 2 Smart USB-A+C Charging, 1 Data Port, 1 Cable Bay	EUD1-HF0B-1212	964.49												
1 Power Receptacle, 2 Smart USB-A+C Charging, 3 Data Ports	EUD1-HF0B-1230	964.49												
1 Power Receptacle, 3 Smart USB-A+C Charging, 1 Cable Bay	EUD1-HF0B-1302	1063.39												
1 Power Receptacle, 3 Smart USB-A+C Charging, 2 Data Ports	EUD1-HF0B-1320	1063.39												
1 Power Receptacle, 4 Smart USB-A+C Charging, 1 Data Port	EUD1-HF0B-1410	1162.29												
2 Power Receptacles, 2 Cable Bays	EUD1-HF0B-2004	766.69												
2 Power Receptacles, 2 Data Ports, 1 Cable Bay	EUD1-HF0B-2022	766.69												
2 Power Receptacles, 4 Data Ports	EUD1-HF0B-2040	766.69												
2 Power Receptacles, 1 Smart USB-A+C Charging, 1 Data Port, 1 Cable Bay	EUD1-HF0B-2112	865.59												
2 Power Receptacles, 1 Smart USB-A+C Charging, 3 Data Ports	EUD1-HF0B-2130	865.59												
2 Power Receptacles, 2 Smart USB-A+C Charging, 1 Cable Bay	EUD1-HF0B-2202	964.49												
2 Power Receptacles, 2 Smart USB-A+C Charging, 2 Data Ports	EUD1-HF0B-2220	964.49												
2 Power Receptacles, 3 Smart USB-A+C Charging, 1 Data Port	EUD1-HF0B-2310	1063.39												
2 Power Receptacles, 4 Smart USB-A+C Charging	EUD1-HF0B-2400	1162.29												
3 Power Receptacles, 3 Data Ports	EUD1-HF0B-3030	766.69												
3 Power Receptacles, 1 Smart USB-A+C Charging, 1 Cable Bay	EUD1-HF0B-3102	865.59												
3 Power Receptacles, 1 Smart USB-A+C Charging, 2 Data Ports	EUD1-HF0B-3120	865.59												
3 Power Receptacles, 2 Smart USB-A+C Charging, 1 Data Port	EUD1-HF0B-3210	964.49												
3 Power Receptacles, 3 Smart USB-A+C Charging	EUD1-HF0B-3300	1063.39												
4 Power Receptacles, 1 Cable Bay	EUD1-HF0B-4002	766.69												
4 Power Receptacles, 2 Data Ports	EUD1-HF0B-4020	766.69												
4 Power Receptacles, 1 Smart USB-A+C Charging, 1 Data Port	EUD1-HF0B-4110	865.59												
4 Power Receptacles, 2 Smart USB-A+C Charging	EUD1-HF0B-4200	964.49												
5 Power Receptacles, 1 Data Port	EUD1-HF0B-5010	766.69												
5 Power Receptacles, 1 Smart USB-A+C Charging	EUD1-HF0B-5100	865.59												
6 Power Receptacles	EUD1-HF0B-6000	766.69												

Electrical Components

Enhanced Power Module — Hardwire

Top Width	Top Depth	Conduit Length	Housing Color	Port Color	Port	Configuration	Number	Price
5" (127mm)	3" (76mm)	6' (1829mm)	Clear Anodized	White	3	1 Power Receptacle, 1 Cable Bay	EUD1-HF0W-1002	\$509.58
						1 Power Receptacle, 2 Data Ports	EUD1-HF0W-1020	509.58
						1 Power Receptacle, 1 Data Port, 1 Smart USB-A+C Charging	EUD1-HF0W-1110	608.48
						1 Power Receptacle, 2 Smart USB-A+C Charging	EUD1-HF0W-1200	707.38
						2 Power Receptacles, 1 Data Port	EUD1-HF0W-2010	509.58
						2 Power Receptacles, 1 Smart USB-A+C Charging	EUD1-HF0W-2100	608.48
						3 Power Receptacles	EUD1-HF0W-3000	509.58
6.5" (165mm)	3" (76mm)				4	1 Power Receptacle, 1 Data Port, 1 Cable Bay	EUD1-HF0W-1012	\$509.58
						1 Power Receptacle, 3 Data Ports	EUD1-HF0W-1030	509.58
						1 Power Receptacle, 1 Smart USB-A+C Charging, 1 Cable Bay	EUD1-HF0W-1102	608.48
						1 Power Receptacle, 3 Smart USB-A+C Charging	EUD1-HF0W-1300	806.28
						2 Power Receptacles, 1 Cable Bay	EUD1-HF0W-2002	509.58
						2 Power Receptacles, 2 Data Ports	EUD1-HF0W-2020	509.58
						2 Power Receptacles, 1 Smart USB-A+C Charging, 1 Data Port	EUD1-HF0W-2110	608.48
						2 Power Receptacles, 2 Smart USB-A+C Charging	EUD1-HF0W-2200	707.38
						3 Power Receptacles, 1 Data Port	EUD1-HF0W-3010	509.58
						3 Power Receptacles, 1 Smart USB-A+C Charging	EUD1-HF0W-3100	608.48
						4 Power Receptacles	EUD1-HF0W-4000	509.58
9.5" (241mm)	3" (76mm)				6	1 Power Receptacle, 1 Smart USB-A+C Charging, 2 Cable Bays	EUD1-HF0W-1104	\$694.18
						1 Power Receptacle, 1 Smart USB-A+C Charging, 2 Data Ports, 1 Cable Bay	EUD1-HF0W-1122	694.18
						1 Power Receptacle, 1 Smart USB-A+C Charging, 4 Data Ports	EUD1-HF0W-1140	694.18
						1 Power Receptacle, 2 Smart USB-A+C Charging, 1 Data Port, 1 Cable Bay	EUD1-HF0W-1212	793.08
						1 Power Receptacle, 2 Smart USB-A+C Charging, 3 Data Ports	EUD1-HF0W-1230	793.08
						1 Power Receptacle, 3 Smart USB-A+C Charging, 1 Cable Bay	EUD1-HF0W-1302	891.98
						1 Power Receptacle, 3 Smart USB-A+C Charging, 2 Data Ports	EUD1-HF0W-1320	891.98
						1 Power Receptacle, 4 Smart USB-A+C Charging, 1 Data Port	EUD1-HF0W-1410	990.88
						2 Power Receptacles, 2 Cable Bays	EUD1-HF0W-2004	595.28
						2 Power Receptacles, 2 Data Ports, 1 Cable Bay	EUD1-HF0W-2022	595.28
						2 Power Receptacles, 4 Data Ports	EUD1-HF0W-2040	595.28
						2 Power Receptacles, 1 Smart USB-A+C Charging, 1 Data Port, 1 Cable Bay	EUD1-HF0W-2112	694.18
						2 Power Receptacles, 1 Smart USB-A+C Charging, 3 Data Ports	EUD1-HF0W-2130	694.18
						2 Power Receptacles, 2 Smart USB-A+C Charging, 1 Cable Bay	EUD1-HF0W-2202	793.08
						2 Power Receptacles, 2 Smart USB-A+C Charging, 2 Data Ports	EUD1-HF0W-2220	793.08
						2 Power Receptacles, 3 Smart USB-A+C Charging, 1 Data Port	EUD1-HF0W-2310	891.98
						2 Power Receptacles, 4 Smart USB-A+C Charging	EUD1-HF0W-2400	990.88
						3 Power Receptacles, 3 Data Ports	EUD1-HF0W-3030	595.28
						3 Power Receptacles, 1 Smart USB-A+C Charging, 1 Cable Bay	EUD1-HF0W-3102	694.18
						3 Power Receptacles, 1 Smart USB-A+C Charging, 2 Data Ports	EUD1-HF0W-3120	694.18
						3 Power Receptacles, 2 Smart USB-A+C Charging, 1 Data Port	EUD1-HF0W-3210	793.08
3 Power Receptacles, 3 Smart USB-A+C Charging	EUD1-HF0W-3300	891.98						
4 Power Receptacles, 1 Cable Bay	EUD1-HF0W-4002	595.28						
4 Power Receptacles, 2 Data Ports	EUD1-HF0W-4020	595.28						
4 Power Receptacles, 1 Smart USB-A+C Charging, 1 Data Port	EUD1-HF0W-4110	694.18						
4 Power Receptacles, 2 Smart USB-A+C Charging	EUD1-HF0W-4200	793.08						
5 Power Receptacles, 1 Data Port	EUD1-HF0W-5010	595.28						
5 Power Receptacles, 1 Smart USB-A+C Charging	EUD1-HF0W-5100	694.18						
6 Power Receptacles	EUD1-HF0W-6000	595.28						

Electrical Components

Enhanced Power Module — Hardwire

Top Width	Top Depth	Conduit Length	Housing Color	Port Color	Port	Configuration	Number	Price						
5" (127mm)	3" (76mm)	12' (3658mm)	Black Anodized	Black	3	1 Power Receptacle, 1 Cable Bay	EUD1-HL0B-1002	\$ 761.56						
						1 Power Receptacle, 2 Data Ports	EUD1-HL0B-1020	761.56						
						1 Power Receptacle, 1 Data Port, 1 Smart USB-A+C Charging	EUD1-HL0B-1110	860.46						
						1 Power Receptacle, 2 Smart USB-A+C Charging	EUD1-HL0B-1200	959.36						
						2 Power Receptacles, 1 Data Port	EUD1-HL0B-2010	761.56						
						2 Power Receptacles, 1 Smart USB-A+C Charging	EUD1-HL0B-2100	860.46						
						3 Power Receptacles	EUD1-HL0B-3000	761.56						
6.5" (165mm)	3" (76mm)				4	1 Power Receptacle, 1 Data Port, 1 Cable Bay	EUD1-HL0B-1012	\$ 761.56						
						1 Power Receptacle, 3 Data Ports	EUD1-HL0B-1030	761.56						
						1 Power Receptacle, 1 Smart USB-A+C Charging, 1 Cable Bay	EUD1-HL0B-1102	860.46						
						1 Power Receptacle, 3 Smart USB-A+C Charging	EUD1-HL0B-1300	1058.26						
						2 Power Receptacles, 1 Cable Bay	EUD1-HL0B-2002	761.56						
						2 Power Receptacles, 2 Data Ports	EUD1-HL0B-2020	761.56						
						2 Power Receptacles, 1 Smart USB-A+C Charging, 1 Data Port	EUD1-HL0B-2110	860.46						
						2 Power Receptacles, 2 Smart USB-A+C Charging	EUD1-HL0B-2200	959.36						
						3 Power Receptacles, 1 Data Port	EUD1-HL0B-3010	761.56						
						3 Power Receptacles, 1 Smart USB-A+C Charging	EUD1-HL0B-3100	860.46						
						4 Power Receptacles	EUD1-HL0B-4000	761.56						
						9.5" (241mm)	3" (76mm)				6	1 Power Receptacle, 1 Smart USB-A+C Charging, 2 Cable Bays	EUD1-HL0B-1104	\$ 946.16
												1 Power Receptacle, 1 Smart USB-A+C Charging, 2 Data Ports, 1 Cable Bay	EUD1-HL0B-1122	946.16
1 Power Receptacle, 1 Smart USB-A+C Charging, 4 Data Ports	EUD1-HL0B-1140	946.16												
1 Power Receptacle, 2 Smart USB-A+C Charging, 1 Data Port, 1 Cable Bay	EUD1-HL0B-1212	1045.06												
1 Power Receptacle, 2 Smart USB-A+C Charging, 3 Data Ports	EUD1-HL0B-1230	1045.06												
1 Power Receptacle, 3 Smart USB-A+C Charging, 1 Cable Bay	EUD1-HL0B-1302	1143.96												
1 Power Receptacle, 3 Smart USB-A+C Charging, 2 Data Ports	EUD1-HL0B-1320	1143.96												
1 Power Receptacle, 4 Smart USB-A+C Charging, 1 Data Port	EUD1-HL0B-1410	1242.86												
2 Power Receptacles, 2 Cable Bays	EUD1-HL0B-2004	847.26												
2 Power Receptacles, 2 Data Ports, 1 Cable Bay	EUD1-HL0B-2022	847.26												
2 Power Receptacles, 4 Data Ports	EUD1-HL0B-2040	847.26												
2 Power Receptacles, 1 Smart USB-A+C Charging, 1 Data Port, 1 Cable Bay	EUD1-HL0B-2112	946.16												
2 Power Receptacles, 1 Smart USB-A+C Charging, 3 Data Ports	EUD1-HL0B-2130	946.16												
2 Power Receptacles, 2 Smart USB-A+C Charging, 1 Cable Bay	EUD1-HL0B-2202	1045.06												
2 Power Receptacles, 2 Smart USB-A+C Charging, 2 Data Ports	EUD1-HL0B-2220	1045.06												
2 Power Receptacles, 3 Smart USB-A+C Charging, 1 Data Port	EUD1-HL0B-2310	1143.96												
2 Power Receptacles, 4 Smart USB-A+C Charging	EUD1-HL0B-2400	1242.86												
3 Power Receptacles, 3 Data Ports	EUD1-HL0B-3030	847.26												
3 Power Receptacles, 1 Smart USB-A+C Charging, 1 Cable Bay	EUD1-HL0B-3102	946.16												
3 Power Receptacles, 1 Smart USB-A+C Charging, 2 Data Ports	EUD1-HL0B-3120	946.16												
3 Power Receptacles, 2 Smart USB-A+C Charging, 1 Data Port	EUD1-HL0B-3210	1045.06												
3 Power Receptacles, 3 Smart USB-A+C Charging	EUD1-HL0B-3300	1143.96												
4 Power Receptacles, 1 Cable Bay	EUD1-HL0B-4002	847.26												
4 Power Receptacles, 2 Data Ports	EUD1-HL0B-4020	847.26												
4 Power Receptacles, 1 Smart USB-A+C Charging, 1 Data Port	EUD1-HL0B-4110	946.16												
4 Power Receptacles, 2 Smart USB-A+C Charging	EUD1-HL0B-4200	1045.06												
5 Power Receptacles, 1 Data Port	EUD1-HL0B-5010	847.26												
5 Power Receptacles, 1 Smart USB-A+C Charging	EUD1-HL0B-5100	946.16												
6 Power Receptacles	EUD1-HL0B-6000	847.26												

Electrical Components

Enhanced Power Module — Hardwire

Top Width	Top Depth	Conduit Length	Housing Color	Port Color	Port	Configuration	Number	Price
5" (127mm)	3" (76mm)	12' (3658mm)	Clear Anodized	White	3	1 Power Receptacle, 1 Cable Bay	EUD1-HLOW-1002	\$ 590.15
						1 Power Receptacle, 2 Data Ports	EUD1-HLOW-1020	590.15
						1 Power Receptacle, 1 Data Port, 1 Smart USB-A+C Charging	EUD1-HLOW-1110	689.05
						1 Power Receptacle, 2 Smart USB-A+C Charging	EUD1-HLOW-1200	787.95
						2 Power Receptacles, 1 Data Port	EUD1-HLOW-2010	590.15
						2 Power Receptacles, 1 Smart USB-A+C Charging	EUD1-HLOW-2100	689.05
						3 Power Receptacles	EUD1-HLOW-3000	590.15
						6.5" (165mm)	3" (76mm)	
1 Power Receptacle, 3 Data Ports	EUD1-HLOW-1030	590.15						
1 Power Receptacle, 1 Smart USB-A+C Charging, 1 Cable Bay	EUD1-HLOW-1102	689.05						
1 Power Receptacle, 3 Smart USB-A+C Charging	EUD1-HLOW-1300	886.85						
2 Power Receptacles, 1 Cable Bay	EUD1-HLOW-2002	590.15						
2 Power Receptacles, 2 Data Ports	EUD1-HLOW-2020	590.15						
2 Power Receptacles, 1 Smart USB-A+C Charging, 1 Data Port	EUD1-HLOW-2110	689.05						
2 Power Receptacles, 2 Smart USB-A+C Charging	EUD1-HLOW-2200	787.95						
9.5" (241mm)	3" (76mm)				6	1 Power Receptacle, 1 Smart USB-A+C Charging, 2 Cable Bays	EUD1-HLOW-1104	\$ 774.75
						1 Power Receptacle, 1 Smart USB-A+C Charging, 2 Data Ports, 1 Cable Bay	EUD1-HLOW-1122	774.75
						1 Power Receptacle, 1 Smart USB-A+C Charging, 4 Data Ports	EUD1-HLOW-1140	774.75
						1 Power Receptacle, 2 Smart USB-A+C Charging, 1 Data Port, 1 Cable Bay	EUD1-HLOW-1212	873.65
						1 Power Receptacle, 2 Smart USB-A+C Charging, 3 Data Ports	EUD1-HLOW-1230	873.65
						1 Power Receptacle, 3 Smart USB-A+C Charging, 1 Cable Bay	EUD1-HLOW-1302	972.55
						1 Power Receptacle, 3 Smart USB-A+C Charging, 2 Data Ports	EUD1-HLOW-1320	972.55
						1 Power Receptacle, 4 Smart USB-A+C Charging, 1 Data Port	EUD1-HLOW-1410	1071.45
						2 Power Receptacles, 2 Cable Bays	EUD1-HLOW-2004	675.85
						2 Power Receptacles, 2 Data Ports, 1 Cable Bay	EUD1-HLOW-2022	675.85
						2 Power Receptacles, 4 Data Ports	EUD1-HLOW-2040	675.85
						2 Power Receptacles, 1 Smart USB-A+C Charging, 1 Data Port, 1 Cable Bay	EUD1-HLOW-2112	774.75
						2 Power Receptacles, 1 Smart USB-A+C Charging, 3 Data Ports	EUD1-HLOW-2130	774.75
						2 Power Receptacles, 2 Smart USB-A+C Charging, 1 Cable Bay	EUD1-HLOW-2202	873.65
						2 Power Receptacles, 2 Smart USB-A+C Charging, 2 Data Ports	EUD1-HLOW-2220	873.65
						2 Power Receptacles, 3 Smart USB-A+C Charging, 1 Data Port	EUD1-HLOW-2310	972.55
						2 Power Receptacles, 4 Smart USB-A+C Charging	EUD1-HLOW-2400	1071.45
						3 Power Receptacles, 3 Data Ports	EUD1-HLOW-3030	675.85
3 Power Receptacles, 1 Smart USB-A+C Charging, 1 Cable Bay	EUD1-HLOW-3102	774.75						
3 Power Receptacles, 1 Smart USB-A+C Charging, 2 Data Ports	EUD1-HLOW-3120	774.75						
3 Power Receptacles, 2 Smart USB-A+C Charging, 1 Data Port	EUD1-HLOW-3210	873.65						
3 Power Receptacles, 3 Smart USB-A+C Charging	EUD1-HLOW-3300	972.55						
4 Power Receptacles, 1 Cable Bay	EUD1-HLOW-4002	675.85						
4 Power Receptacles, 2 Data Ports	EUD1-HLOW-4020	675.85						
4 Power Receptacles, 1 Smart USB-A+C Charging, 1 Data Port	EUD1-HLOW-4110	774.75						
4 Power Receptacles, 2 Smart USB-A+C Charging	EUD1-HLOW-4200	873.65						
5 Power Receptacles, 1 Data Port	EUD1-HLOW-5010	675.85						
5 Power Receptacles, 1 Smart USB-A+C Charging	EUD1-HLOW-5100	774.75						
6 Power Receptacles	EUD1-HLOW-6000	675.85						

Electrical Components

Enhanced Power Module — Spiral Corded — Height Adjustable

Top Depth	Top Width	Cord Length	Housing Color	Port Color	Port	Configuration	Number	Price
3" (76mm)	6.5" (165mm)	10'(3048mm)-12'(3658mm)	Black Anodized	Black	4	2 Power Receptacles, 1 Smart USB-A+C Charging, 1 Data Port	EUD1-SF0B-2110	\$1047.43
					4	2 Power Receptacles, 2 Smart USB-A+C Charging	EUD1-SF0B-2200	1146.33
					4	3 Power Receptacles, 1 Data Port	EUD1-SF0B-3010	948.53
					4	3 Power Receptacles, 1 Smart USB-A+C Charging	EUD1-SF0B-3100	1047.43
					4	4 Power Receptacles	EUD1-SF0B-4000	948.53
			Clear Anodized	White	4	2 Power Receptacles, 1 Smart USB-A+C Charging, 1 Data Port	EUD1-SF0W-2110	\$ 876.02
					4	2 Power Receptacles, 2 Smart USB-A+C Charging	EUD1-SF0W-2200	974.92
					4	3 Power Receptacles, 1 Data Port	EUD1-SF0W-3010	777.12
					4	3 Power Receptacles, 1 Smart USB-A+C Charging	EUD1-SF0W-3100	876.02
					4	4 Power Receptacles	EUD1-SF0W-4000	777.12

4-Port:

- (2) Power
- (1) Smart USB-A+C
- (1) Data

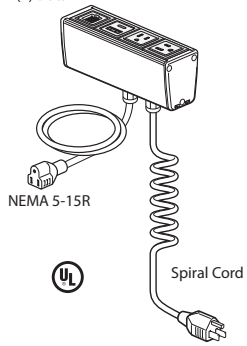

EUD1-SF0B-2110

4-Port:
(4) Power

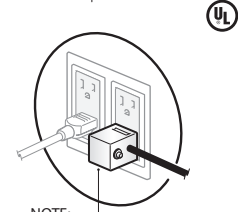
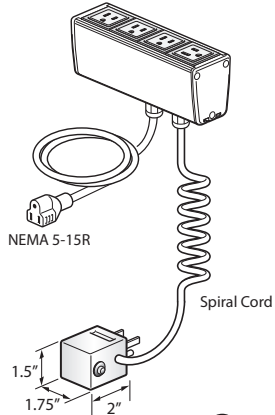

NOTE:
Always Circuit Breaker Plug when more than 3 power outlets specified.

EUD1-SF0B-4000

Features

- Includes power module with 3, 4 or 6 ports that can be configured with simplex outlets (NEMA-5-15R), USB charging port (Smart USB-A+C) , data ports or cable bay(s) that can accept up to two pull out data/AV cables and mounting hardware.
- Data port accommodate most varieties of field supplied data/ AV jacks.
- Spiral Cord includes 15 amp plug (NEMA 5-15P) and expands to 12'(3658mm) when stretched.
- Auxiliary 24"(610mm) power cord with NEMA 5-15R used to provide power to table motor controller.
- Attaches to surface with use of separately specified mounting brackets.
- The Smart USB-A+C allows for the 20W to be transferred between the 2 ports. If the USB-A is being used, the full wattage is sent to the USB-A, and the same for the USB-C. If both are being used, the wattage is distributed to each port and the port drawing the most power will receive more watts than the one that is not.
- Color option of black anodized housing with black receptacles or clear anodized housing with white receptacles.

To Order, Specify:

- 1) Product number.
(No finish specification required.)

Specification Tips

- **Configuration and quantity of power and data ports cannot be modified in the field.**
- **For use with 120 volt 60 hertz power source only.**
- **For use with:**
 - Planes or Planes LT Model Height Adjustable Tables
 - Planes or Planes LT Model Height Adjustable Bench
 - Upside+ or Upside Model Height Adjustable Tables
- Separately specify attachment hardware for desired application.
- Not for use with cable chain.
- Requires field installation.
- Application may require approval of local authority having jurisdiction (AHJ); ensure compliance before placing orders and installation.

Electrical Components

Enhanced Power Module — Cord for Height Adjustable

Top Depth	Top Width	Cord Length	Housing Color	Port Color	Port	Configuration	Number	Price
3" (76mm)	6.5" (165mm)	10'(3048mm)- 12'(3658mm)	Black Anodized	Black	4	2 Power Receptacles, 1 Smart USB-A+C Charging, 1 Data Port	EUD1-SL0B-2110	\$1128.00
					4	2 Power Receptacles, 2 Smart USB-A+C Charging	EUD1-SL0B-2200	1226.90
					4	3 Power Receptacles, 1 Data Port	EUD1-SL0B-3010	1029.10
					4	3 Power Receptacles, 1 Smart USB-A+C Charging	EUD1-SL0B-3100	1128.00
					4	4 Power Receptacles	EUD1-SL0B-4000	1029.10
			Clear Anodized	White	4	2 Power Receptacles, 1 Smart USB-A+C Charging, 1 Data Port	EUD1-SL0W-2110	\$ 956.59
					4	2 Power Receptacles, 2 Smart USB-A+C Charging	EUD1-SL0W-2200	1055.49
					4	3 Power Receptacles, 1 Data Port	EUD1-SL0W-3010	857.69
					4	3 Power Receptacles, 1 Smart USB-A+C Charging	EUD1-SL0W-3100	956.59
					4	4 Power Receptacles	EUD1-SL0W-4000	857.69

4-Port:

- (2) Power
- (1) Smart USB-A+C
- (1) Data

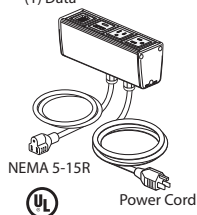

EUD1-SL0B-2110

4-Port:

- (4) Power

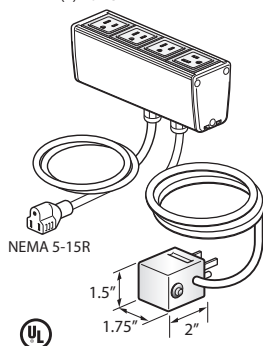

EUD1-SL0B-4000

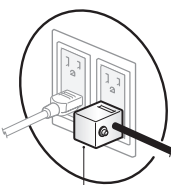

NOTE:
Always Circuit Breaker Plug
when more than 3
power outlets specified.

Features

- Includes power module with 3, 4 or 6 ports that can be configured with simplex outlets (NEMA-5-15R), USB charging port (Smart USB-A+C), data ports or cable bay(s) that can accept up to two pull out data/AV cables and mounting hardware.
- Data port accommodate most varieties of field supplied data/AV jacks.
- Corded power module with 15 amp - 12'(3658mm) long cord with plug (NEMA 5-15P).
- Auxiliary 24"(610mm) power cord with NEMA 5-15R used to provide power to table motor controller.
- Attaches to surface with use of separately specified mounting brackets.
- The Smart USB-A+C allows for the 20W to be transferred between the 2 ports. If the USB-A is being used, the full wattage is sent to the USB-A, and the same for the USB-C. If both are being used, the wattage is distributed to each port and the port drawing the most power will receive more watts than the one that is not.
- Color option of black anodized housing with black receptacles or clear anodized housing with white receptacles.

To Order, Specify:

- 1) Product number.
(No finish specification required.)

Specification Tips

- **Configuration and quantity of power and data ports cannot be modified in the field.**
- **For use with 120 volt 60 hertz power source only.**
- **For use with:**
 - Planes or Planes LT Model Height Adjustable Tables
 - Planes or Planes LT Model Height Adjustable Benching
 - Upside+ or Upside Model Height Adjustable Tables
- Separately specify attachment hardware for desired application.
- Designed to be used with cable chain.
- Requires field installation.
- Application may require approval of local authority having jurisdiction (AHJ); ensure compliance before placing orders and installation.

Electrical Components

Enhanced Power Module Brackets

	Height	Width	Length	Description	Number	Price
Above Worksurface – Adjustable	4"(102mm)	3.5"(89mm)	3.5"(89mm)	Black Bracket	EUDB-0000-HB	\$89.96
				White Bracket	EUDB-0000-HW	89.96

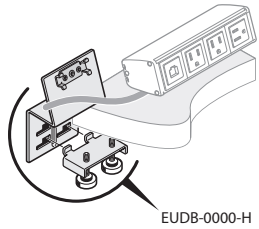

Features

- Includes bracket and mounting hardware.
- For use with 3, 4 or 6 port Enhanced Power Module and 2-6 port Seamless Enhanced Power Modules.
- Available in black or white.
- Mounts to back edge of 1.18"(30mm) to 2"(51mm) worktop.
- Not for use with a tack board.

To Order, Specify:

- 1) Product number.
(No finish specification required.)

Specification Tips

- Specify Enhanced Power Module separately.
- Requires field installation.
- Application may require approval of local authority having jurisdiction (AHJ); ensure compliance before placing orders and installation.

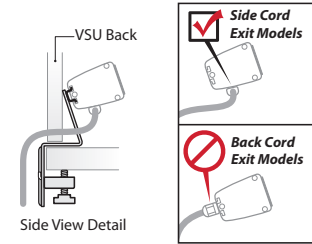

EUDB-0000-H
Class YA - SIN 33721
Discount Group XIII

Above Worksurface – Adjustable for Knife Edge	4"(102mm)	3.5"(89mm)	3.5"(89mm)	Black Bracket	EUDB-0000-NB	\$129.79
				White Bracket	EUDB-0000-NW	129.79

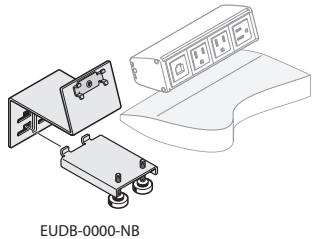

Features

- Includes bracket and mounting hardware.
- For use with 3, 4 or 6 port Enhanced Power Module and 2-6 port Seamless Enhanced Power Modules.
- Available in black or white.
- Mounts to worksurface edge.

To Order, Specify:

- 1) Product number.
(No finish specification required.)

Specification Tips

- Designed to be used with 1.18"(30mm) thick surfaces with clear space below.
- Specify Enhanced Power Module separately.
- Requires field installation.
- Application may require approval of local authority having jurisdiction (AHJ); ensure compliance before placing orders and installation.
- Designed to be used with knife edge worksurfaces.

EUDB-0000-N
Class YA – GSA: Open Market



Electrical Components

Enhanced Power Module Brackets

	Height	Width	Length	Description	Number	Price
Above Worksurface – Adjustable with Tackboard Offset	4"(102mm)	3.5"(89mm)	3.5"(89mm)	Black Bracket	EUDB-0000-TB	\$89.96
				White Bracket	EUDB-0000-TW	89.96

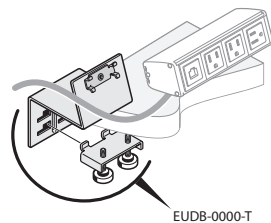

Features

- Includes bracket and mounting hardware.
- For use with 3, 4 or 6 port Enhanced Power Module and 2-6 port Seamless Enhanced Power Modules.
- Available in black or white.
- Mounts to back edge of 1.18"(30mm) to 2"(51mm) worktop when a tackboard or slat, glass, laminate or veneer tile is present.

To Order, Specify:

- 1) Product number.
(No finish specification required.)

Specification Tips

- Specify Enhanced Power Module separately.
- Requires field installation.
- Application may require approval of local authority having jurisdiction (AHJ); ensure compliance before placing orders and installation.

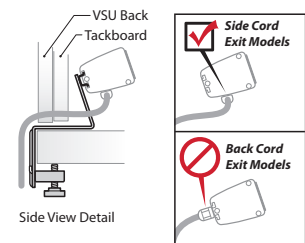

EUDB-0000-T

Above Worksurface – Fixed	4.25"(107mm)	3"(76mm)	2"(51mm)	Black Bracket	EUDB-0000-WB	\$89.96
				White Bracket	EUDB-0000-WW	89.96

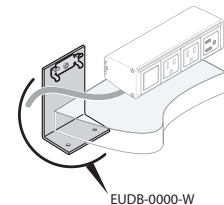

Features

- Includes bracket and mounting hardware.
- For use with 3, 4 or 6 port Enhanced Power Module and 2-6 port Seamless Enhanced Power Modules.
- Available in black or white.
- Mounts under worksurface with Enhanced Power Module above worksurface.

To Order, Specify:

- 1) Product number.
(No finish specification required.)

Specification Tips

- Designed to be used with 1.18" (30mm) thick surfaces with clear space below.
- Specify Enhanced Power Module separately.
- Requires field installation.
- Application may require approval of local authority having jurisdiction (AHJ); ensure compliance before placing orders and installation.

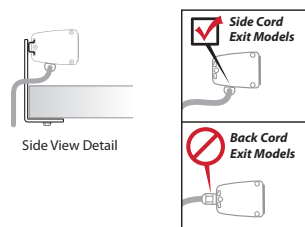

EUDB-0000-W

Under Worksurface – Fixed	2"(51mm)	3"(76mm)	2.5"(64mm)	Black Bracket	EUDB-0000-UB	\$89.96
				White Bracket	EUDB-0000-UW	89.96

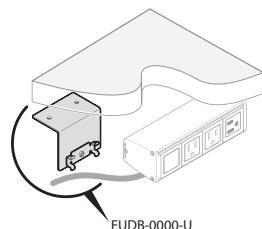

Features

- Includes bracket and mounting hardware.
- For use with 3, 4 or 6 port Enhanced Power Module and 2-6 port Seamless Enhanced Power Modules.
- Available in black or white.
- Mounts under worksurface with offset to accommodate most transformer plugs.

To Order, Specify:

- 1) Product number.
(No finish specification required.)

Specification Tips

- Designed to be used with 1.18"(30mm) thick surfaces with clear space below.
- Specify Enhanced Power Module separately.
- Requires field installation.
- Application may require approval of local authority having jurisdiction (AHJ); ensure compliance before placing orders and installation.

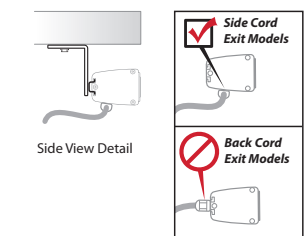

EUDB-0000-U

Electrical Components

Enhanced Power Module Bracket

	Height	Width	Depth	Trim Color	Number	Price
For Use with X Series	5"(127mm)	2.375"(60mm)	1.125"(29mm)	Black	EUDB-0000-JB	\$89.96
				White	EUDB-0000-JW	\$89.96

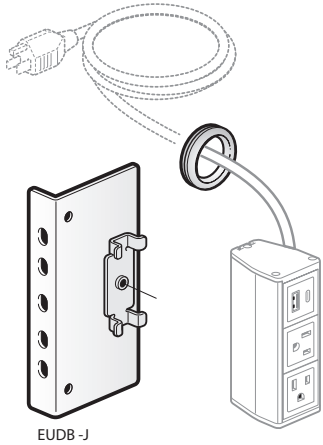

EUDB-J

Features

- Includes bracket, grommet and mounting hardware.
- Field installed.

Specification Tips

- Bracket designed to be used with Enhanced Power Module only.
- Designed to be used in X Series open storage cavities of lockers, group lockers, cubby lockers and combination units.
- Cannot be used in drawers or personal storage towers.
- A 1.25"(32mm) diameter Greenlee punch is recommended to punch the power hole through the back of our products (lockers).
- Application may require approval of local authority having jurisdiction (AHJ); ensure compliance before placing orders and installation.

To Order, Specify:

- 1) Product number.

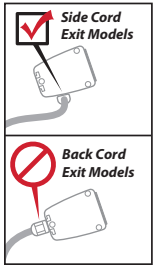

EUDB-J

Electrical Components

Flip Top Unit with Smooth Bezel – Corded – Single-Sided

Power, Data and USB

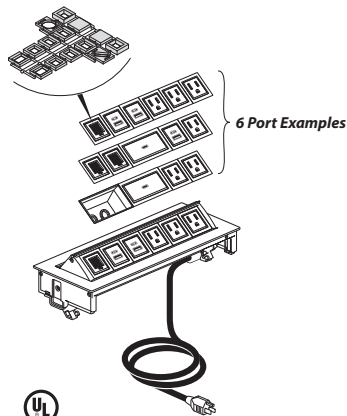

EUC1-PF0P-311010

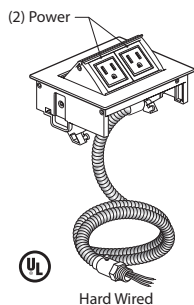

EUC1-PF0P-200000

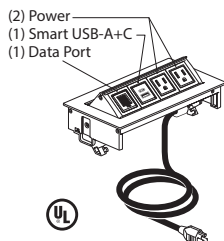

EUC1-PF0P-210010

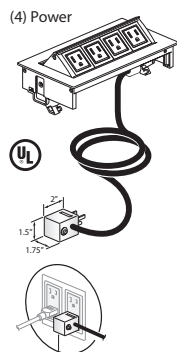

NOTE:
Always Circuit Breaker Plug when more than three power outlets specified.

EUC1-PF0P-400000

Features

- Includes flip top with smooth bezel module with 2, 4, or 6 ports configured with simplex outlets (NEMA 5-15R), USB charging port (USB-C 60W, Smart USB-A+C), data port(s) or cable bay, and mounting hardware.
- The Smart USB-A+C allows for the 20W to be transferred between the 2 ports. If the USB-A is being used, the full wattage is sent to the USB-A, and the same for the USB-C. If both are being used, the wattage is distributed to each port and the port drawing the most power will receive more watts than the one that is not.
- Data jack adapters accommodate most varieties of field supplied data jacks or separately specified AV cables. Occupies one port.
- Each cable bay can accept up to two pull out data/AV cables. Occupies two ports.
- Smart USB-A+C can provide fast charge for a mobile phone and tablets. Occupies one charging port.
- USB-C 60W can charge phone, tablets and some laptops. Occupies two ports.
- Smooth bezel is painted and features non mitered corners.
- Port color is either black or white based on smooth bezel color.
- Flip top unit is flush mounted with spring release cover.
- Flip top unit overall height is 2.75"(70mm) and will extend below the table top.
- Corded power module available with 15 amp - 6'(1829mm) or 10'(3048mm) long cord with plug (NEMA 5-15P).
- Ships assembled.

To Order, Specify:

- 1) Product number.
- 2) Finish color for Bezel/Port.
 TR-PM1 Silver/White
 TR-PM2 Midnight Black/Black
 TR-PM8 Matte White/White
 TR-PM9 Matte Grey/Black

Note: Order flip top units to match flip top unit cutout option specified for each top (A/B, F/V or J/K).

Specification Tips

- Designed to be used with 1.18"(30mm) and 2"(51mm) thick surfaces with clear space below.
- **Configuration and quantity of ports cannot be modified in the field.**
- **For use with 120 volt 60 hertz power source only.**
- Requires field installation.
- Specify factory cut hole or field cut hole as required.
- Specify AV cables separately.
- Cable Bay requires cables less than 0.3"(7.6mm) diameter.
- Corded flip top units with four or more receptacles utilize a circuit breaker plug that may block adjacent building receptacle outlet.
- Application may require approval of local authority having jurisdiction (AHJ); ensure compliance before placing orders and installation.

2, 4, and 6 Port Examples

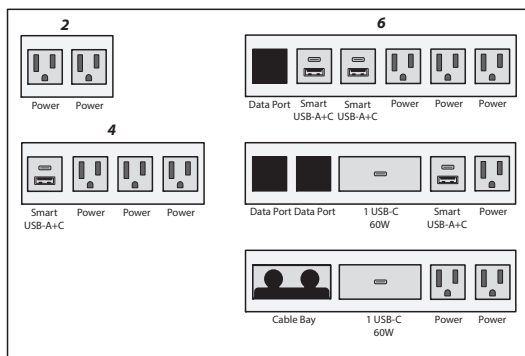

Electrical Components

Flip Top Unit with Smooth Bezel – Corded – Single-Sided

Bezel Width	Bezel Depth	Cord Length	Port	Configuration	Flip Top Unit Cutout Code Options	Number	Price
		6' (1829mm)	2	1 Receptacle, 1 Data Port	A, B	EUC1-PFOP-100010	\$ 707.29
				1 Receptacle, 1 Smart USB-A+C Charging	A, B	EUC1-PFOP-101000	810.81
				2 Receptacles	A, B	EUC1-PFOP-200000	707.29
			4	1 Receptacle, 1 Smart USB-A+C Charging, 1 Data Port	F, V	EUC1-PFOP-111010	943.07
				1 Receptacle, 1 Smart USB-A+C Charging, 1 Cable Bay	F, V	EUC1-PFOP-101001	839.55
				1 Receptacle, 1 USB-C 60W Charging, 1 Data Port	F, V	EUC1-PFOP-100110	1095.29
				2 Receptacles, 1 Cable Bay	F, V	EUC1-PFOP-200001	736.03
				2 Receptacles, 1 USB-C 60W Charging	F, V	EUC1-PFOP-200100	1095.29
				2 Receptacles, 1 Smart USB-A+C Charging, 1 Data Port	F, V	EUC1-PFOP-201010	839.55
				2 Receptacles, 2 Data Ports	F, V	EUC1-PFOP-200020	736.03
				2 Receptacles, 2 Smart USB-A+C Charging	F, V	EUC1-PFOP-202000	943.07
				3 Receptacles, 1 Data Port	F, V	EUC1-PFOP-300010	736.03
				3 Receptacles, 1 Smart USB-A+C Charging	F, V	EUC1-PFOP-301000	839.55
				4 Receptacles	F, V	EUC1-PFOP-400000	736.03
			6	1 Receptacle, 1 Smart USB-A+C Charging, 1 Data Port, 1 Cable Bay	J, K	EUC1-PFOP-111011	\$ 957.44
				1 Receptacle, 1 USB-C 60W Charging, 2 Data Ports	J, K	EUC1-PFOP-110120	1213.18
				1 Receptacle, 1 Smart USB-A+C Charging, 2 Data Ports, 1 Cable Bay	J, K	EUC1-PFOP-101021	853.92
				1 Receptacle, 1 USB-C 60W Charging, 1 Data Port, 1 Cable Bay	J, K	EUC1-PFOP-100111	1109.66
				2 Receptacles, 1 Smart USB-A+C Charging, 1 Cable Bay	J, K	EUC1-PFOP-211001	957.44
				2 Receptacles, 1 Smart USB-A+C Charging, 2 Data Ports	J, K	EUC1-PFOP-211020	957.44
				2 Receptacles, 1 Smart USB-A+C Charging, 3 Data Ports	J, K	EUC1-PFOP-201030	853.92
				2 Receptacles, 1 USB-C 60W Charging, 1 Cable Bay	J, K	EUC1-PFOP-200101	1109.66
				2 Receptacles, 1 USB-C 60W Charging, 2 Data Ports	J, K	EUC1-PFOP-200120	1109.66
				2 Receptacles, 2 Data Ports, 1 Cable Bay	J, K	EUC1-PFOP-200021	750.40
				2 Receptacles, 4 Data Ports	J, K	EUC1-PFOP-200040	750.40
				3 Receptacles, 1 Data Port, 1 Cable Bay	J, K	EUC1-PFOP-300011	750.40
				3 Receptacles, 1 USB-A Charging, 1 Smart USB-A+C Charging, 1 Data Port	J, K	EUC1-PFOP-311010	957.44
				3 Receptacles, 1 Smart USB-A+C Charging, 1 Cable Bay	J, K	EUC1-PFOP-301001	853.92
				3 Receptacles, 1 Smart USB-A+C Charging, 2 Data Ports	J, K	EUC1-PFOP-301020	853.92
				3 Receptacles, 1 USB-C 60W Charging, 1 Data Port	J, K	EUC1-PFOP-300110	1109.66
				3 Receptacles, 3 Data Ports	J, K	EUC1-PFOP-300030	750.40
				4 Receptacles, 1 Cable Bay	J, K	EUC1-PFOP-400001	750.40
				4 Receptacles, 1 Smart USB-A+C Charging, 1 Data Port	J, K	EUC1-PFOP-401010	853.92
				4 Receptacles, 1 USB-C 60W Charging	J, K	EUC1-PFOP-400100	1109.66
				4 Receptacles, 2 Data Ports	J, K	EUC1-PFOP-400020	750.40
				4 Receptacles, 2 Smart USB-A+C Charging	J, K	EUC1-PFOP-402000	957.44
				5 Receptacles, 1 Data Port	J, K	EUC1-PFOP-500010	750.40
				5 Receptacles, 1 Smart USB-A+C Charging	J, K	EUC1-PFOP-501000	853.92
				6 Receptacles	J, K	EUC1-PFOP-600000	750.40

Electrical Components

Flip Top Unit with Smooth Bezel – Corded – Single-Sided

Bezel Width	Bezel Depth	Cord Length	Port	Configuration	Flip Top Unit Cutout Code Options	Number	Price
		10' (3048mm)	2	1 Receptacle, 1 Data Port	A, B	EUC1-PJ0P-100010	\$ 777.78
				1 Receptacle, 1 Smart USB-A+C Charging	A, B	EUC1-PJ0P-101000	881.30
				2 Receptacles	A, B	EUC1-PJ0P-200000	777.78
			4	1 Receptacle, 1 Dual USB-A Charging, 1 Smart USB-A+C Charging, 1 Data Port	F, V	EUC1-PJ0P-111010	1013.56
				1 Receptacle, 1 Smart USB-A+C Charging, 1 Cable Bay	F, V	EUC1-PJ0P-101001	910.04
				1 Receptacle, 1 USB-C 60W Charging, 1 Data Port	F, V	EUC1-PJ0P-100110	1165.78
				2 Receptacles, 1 Cable Bay	F, V	EUC1-PJ0P-200001	806.52
				2 Receptacles, 1 Smart USB-A+C Charging, 1 Data Port	F, V	EUC1-PJ0P-201010	910.04
				2 Receptacles, 1 USB-C 60W Charging	F, V	EUC1-PJ0P-200100	1165.78
				2 Receptacles, 2 Data Ports	F, V	EUC1-PJ0P-200020	806.52
				2 Receptacles, 2 Smart USB-A+C Charging	F, V	EUC1-PJ0P-202000	1013.56
				3 Receptacles, 1 Data Port	F, V	EUC1-PJ0P-300010	806.52
				3 Receptacles, 1 Smart USB-A+C Charging	F, V	EUC1-PJ0P-301000	910.04
				4 Receptacles	F, V	EUC1-PJ0P-400000	806.52
			6	1 Receptacle, 1 Dual USB-A Charging, 1 Smart USB-A+C Charging, 1 Data Port, 1 Cable Bay	J, K	EUC1-PJ0P-111011	\$1027.93
				1 Receptacle, 1 Dual USB-A Charging, 1 USB-C 60W Charging, 2 Data Ports	J, K	EUC1-PJ0P-110120	1283.67
				1 Receptacle, 1 Smart USB-A+C Charging, 2 Data Ports, 1 Cable Bay	J, K	EUC1-PJ0P-101021	924.41
				1 Receptacle, 1 USB-C 60W Charging, 1 Data Port, 1 Cable Bay	J, K	EUC1-PJ0P-100111	1180.15
				2 Receptacles, 1 Dual USB-A Charging, 1 Smart USB-A+C Charging, 1 Cable Bay	J, K	EUC1-PJ0P-211001	1027.93
				2 Receptacles, 1 Dual USB-A Charging, 1 Smart USB-A+C Charging, 2 Data Ports	J, K	EUC1-PJ0P-211020	1027.93
				2 Receptacles, 1 Smart USB-A+C Charging, 3 Data Ports	J, K	EUC1-PJ0P-201030	924.41
				2 Receptacles, 1 USB-C 60W Charging, 1 Cable Bay	J, K	EUC1-PJ0P-200101	1180.15
				2 Receptacles, 1 USB-C 60W Charging, 2 Data Ports	J, K	EUC1-PJ0P-200120	1180.15
				2 Receptacles, 2 Data Ports, 1 Cable Bay	J, K	EUC1-PJ0P-200021	820.89
				2 Receptacles, 4 Data Ports	J, K	EUC1-PJ0P-200040	820.89
				3 Receptacles, 1 Data Port, 1 Cable Bay	J, K	EUC1-PJ0P-300011	820.89
				3 Receptacles, 1 Dual USB-A Charging, 1 Smart USB-A+C Charging, 1 Data Port	J, K	EUC1-PJ0P-311010	1027.93
				3 Receptacles, 1 Smart USB-A+C Charging, 1 Cable Bay	J, K	EUC1-PJ0P-301001	924.41
				3 Receptacles, 1 Smart USB-A+C Charging, 2 Data Ports	J, K	EUC1-PJ0P-301020	924.41
				3 Receptacles, 1 USB-C 60W Charging, 1 Data Port	J, K	EUC1-PJ0P-300110	1180.15
				3 Receptacles, 3 Data Ports	J, K	EUC1-PJ0P-300030	820.89
				4 Receptacles, 1 Cable Bay	J, K	EUC1-PJ0P-400001	820.89
				4 Receptacles, 1 Smart USB-A+C Charging, 1 Data Port	J, K	EUC1-PJ0P-401010	924.41
				4 Receptacles, 1 USB-C 60W Charging	J, K	EUC1-PJ0P-400100	1180.15
				4 Receptacles, 2 Data Ports	J, K	EUC1-PJ0P-400020	820.89
				4 Receptacles, 2 Smart USB-A+C Charging	J, K	EUC1-PJ0P-402000	1027.93
				5 Receptacles, 1 Data Port	J, K	EUC1-PJ0P-500010	820.89
				5 Receptacles, 1 Smart USB-A+C Charging	J, K	EUC1-PJ0P-501000	924.41
				6 Receptacles	J, K	EUC1-PJ0P-600000	820.89

This page intentionally blank

Electrical Components

Flip Top Unit with Smooth Bezel — Corded — Double-Sided

Power, Data and USB

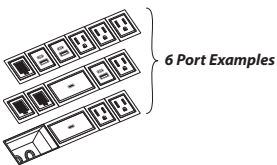
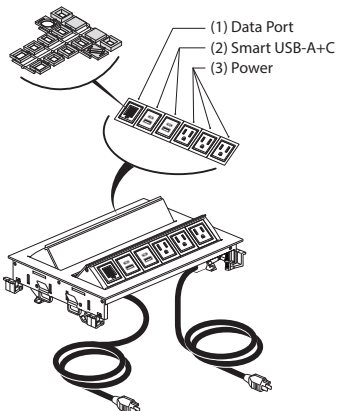

EUC2-PF0P-311010

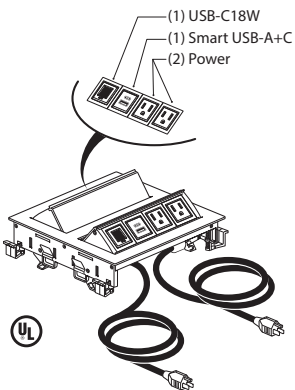

EUC2-PF0P-210010

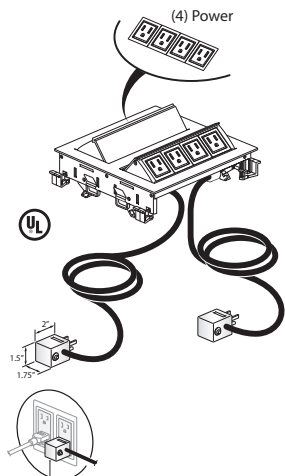

NOTE:
Always Circuit Breaker Plug when more than three power outlets specified.

EUC2-PF0P-400000

Features

- Includes double flip top with smooth bezel module with 2, 4, or 6 ports configured with simplex outlets (NEMA 5-15R), USB charging port (USB-C 60W, Smart USB-A+C), data port(s) or cable bay, and mounting hardware.
- The Smart USB-A+C allows for the 20W to be transferred between the 2 ports. If the USB-A is being used, the full wattage is sent to the USB-A, and the same for the USB-C. If both are being used, the wattage is distributed to each port and the port drawing the most power will receive more watts than the one that is not.
- Data jack adapters accommodate most varieties of field supplied data jacks or separately specified AV cables. Occupies one port.
- Each cable bay can accept up to two pull out data/AV cables. Occupies two ports.
- Smart USB-A+C can provide fast charge for a mobile phone and tablets. Occupies one charging port.
- USB-C 60W can charge phone, tablets and some laptops. Occupies two ports.
- Smooth bezel is painted and features non mitered corners.
- Port color is either black or white based on smooth bezel color.
- Flip top unit is flush mounted with spring release cover.
- Flip top unit overall height is 2.75”(70mm) and will extend below the table top.
- Corded power module available with two 15 amp - 6’(1829mm) or 10’(3048mm) long cord with plug (NEMA 5-15P).
- Ships assembled.

Specification Tips

- Designed to be used with 1.18”(30mm) and 2”(51mm) thick surfaces with clear space below.
- **Configuration and quantity of ports cannot be modified in the field.**
- **For use with 120 volt 60 hertz power source only.**
- Requires field installation.
- Specify factory cut hole or field cut hole as required.
- Specify AV cables separately.
- Cable Bay requires cables less than 0.3”(7.6mm) diameter.
- Corded flip top units with four receptacles utilize a circuit breaker plug that may block adjacent building receptacle outlet.
- Application may require approval of local authority having jurisdiction (AHJ); ensure compliance before placing orders and installation.

Note: Two cord feeds are provided from the double-sided flip top unit.

To Order, Specify:

- 1) Product number.
- 2) Finish color for Bezel/Port.

TR-PM1	Silver/White
TR-PM2	Midnight Black/Black
TR-PM8	Matte White/White
TR-PM9	Matte Grey/Black

Note: Order flip top units to match flip top unit cutout option specified for each top (M/P or Q/T).

Electrical Components

Flip Top Unit with Smooth Bezel — Corded — Double-Sided

Bezel Width	Bezel Depth	Cord Length	Port	Configuration	Flip Top Unit Cutout Code Options	Number	Price
		6' (1829mm)	4	1 Receptacle, 2 Smart USB-A+C Charging, 1 Data Port	M, P	EUC2-PF0P-111010	1702.65
				1 Receptacle, 1 Smart USB-A+C Charging, 1 Cable Bay	M, P	EUC2-PF0P-101001	1599.13
				1 Receptacle, 1 USB-C 60W Charging, 1 Data Port	M, P	EUC2-PF0P-100110	1854.87
				2 Receptacles, 1 USB-C 60W Charging	M, P	EUC2-PF0P-200100	1854.87
				2 Receptacles, 1 Cable Bay	M, P	EUC2-PF0P-200001	1495.61
				2 Receptacles, 1 Smart USB-A+C Charging, 1 Data Port	M, P	EUC2-PF0P-201010	1599.13
				2 Receptacles, 2 Data Ports	M, P	EUC2-PF0P-200020	1495.61
				2 Receptacles, 2 Smart USB-A+C Charging	M, P	EUC2-PF0P-202000	1702.65
				3 Receptacles, 1 Data Port	M, P	EUC2-PF0P-300010	1495.61
				3 Receptacles, 1 Smart USB-A+C Charging	M, P	EUC2-PF0P-301000	1599.13
				4 Receptacles	M, P	EUC2-PF0P-400000	1495.61
			6	1 Receptacle, 2 Smart USB-A+C Charging, 1 Data Port, 1 Cable Bay	Q, T	EUC2-PF0P-111011	\$1760.11
				1 Receptacle, 1 USB-C 60W Charging, 2 Data Ports	Q, T	EUC2-PF0P-110120	2015.85
				1 Receptacle, 1 Smart USB-A+C Charging, 2 Data Ports, 1 Cable Bay	Q, T	EUC2-PF0P-101021	1656.59
				1 Receptacle, 1 USB-C 60W Charging, 1 Data Port, 1 Cable Bay	Q, T	EUC2-PF0P-100111	1912.33
				2 Receptacles, 2 Smart USB-A+C Charging, 1 Cable Bay	Q, T	EUC2-PF0P-211001	1760.11
				2 Receptacles, 2 Smart USB-A+C Charging, 2 Data Ports	Q, T	EUC2-PF0P-211020	1760.11
				2 Receptacles, 1 Smart USB-A+C Charging, 2 Data Ports	Q, T	EUC2-PF0P-201030	1656.59
				2 Receptacles, 1 USB-C 60W Charging, 1 Cable Bay	Q, T	EUC2-PF0P-200101	1912.33
				2 Receptacles, 1 USB-C 60W Charging, 2 Data Ports	Q, T	EUC2-PF0P-200120	1912.33
				2 Receptacles, 2 Data Ports, 1 Cable Bay	Q, T	EUC2-PF0P-200021	1553.07
				2 Receptacles, 4 Data Ports	Q, T	EUC2-PF0P-200040	1553.07
				3 Receptacles, 1 Data Port, 1 Cable Bay	Q, T	EUC2-PF0P-300011	1553.07
				3 Receptacles, 2 Smart USB-A+C Charging, 1 Data Port	Q, T	EUC2-PF0P-311010	1760.11
				3 Receptacles, 1 Smart USB-A+C Charging, 1 Cable Bay	Q, T	EUC2-PF0P-301001	1656.59
				3 Receptacles, 1 Smart USB-A+C Charging, 2 Data Ports	Q, T	EUC2-PF0P-301020	1656.59
				3 Receptacles, 1 USB-C 60W Charging, 1 Data Port	Q, T	EUC2-PF0P-300110	1912.33
				3 Receptacles, 3 Data Ports	Q, T	EUC2-PF0P-300030	1553.07
				4 Receptacles, 2 Dual USB-A Charging	Q, T	EUC2-PF0P-420000	1760.11
				4 Receptacles, 1 Cable Bay	Q, T	EUC2-PF0P-400001	1553.07
				4 Receptacles, 1 Smart USB-A+C Charging, 1 Data Port	Q, T	EUC2-PF0P-401010	1656.59
				4 Receptacles, 1 USB-C 60W Charging	Q, T	EUC2-PF0P-400100	1912.33
				4 Receptacles, 2 Data Ports	Q, T	EUC2-PF0P-400020	1553.07
				4 Receptacles, 2 Smart USB-A+C Charging	Q, T	EUC2-PF0P-402000	1760.11
				5 Receptacles, 1 Data Port	Q, T	EUC2-PF0P-500010	1553.07
				5 Receptacles, 1 Smart USB-A+C Charging	Q, T	EUC2-PF0P-501000	1656.59
				6 Receptacles	Q, T	EUC2-PF0P-600000	1553.07

Electrical Components

Flip Top Unit with Smooth Bezel — Corded — Double-Sided

Bezel Width	Bezel Depth	Cord Length	Port	Configuration	Flip Top Unit Cutout Code Options	Number	Price
		10' (3048mm)	4	1 Receptacle, 2 Smart USB-A+C Charging, 1 Data Port	M, P	EUC2-PJ0P-111010	1773.14
				1 Receptacle, 1 Smart USB-A+C Charging, 1 Cable Bay	M, P	EUC2-PJ0P-101001	1669.62
				1 Receptacle, 1 USB-C 60W Charging, 1 Data Port	M, P	EUC2-PJ0P-100110	1925.36
				2 Receptacles, 1 USB-C 60W Charging	M, P	EUC2-PJ0P-200100	1925.36
				2 Receptacles, 1 Cable Bay	M, P	EUC2-PJ0P-200001	1566.10
				2 Receptacles, 1 Smart USB-A+C Charging, 1 Data Port	M, P	EUC2-PJ0P-201010	1669.62
				2 Receptacles, 2 Data Ports	M, P	EUC2-PJ0P-200020	1566.10
				2 Receptacles, 2 Smart USB-A+C Charging	M, P	EUC2-PJ0P-202000	1773.14
				3 Receptacles, 1 Data Port	M, P	EUC2-PJ0P-300010	1566.10
				3 Receptacles, 1 Smart USB-A+C Charging	M, P	EUC2-PJ0P-301000	1669.62
				4 Receptacles	M, P	EUC2-PJ0P-400000	1566.10
			6	1 Receptacle, 2 Smart USB-A+C Charging, 1 Data Port, 1 Cable Bay	Q, T	EUC2-PJ0P-111011	\$1830.60
				1 Receptacle, 1 USB-C 60W Charging, 2 Data Ports	Q, T	EUC2-PJ0P-110120	2086.34
				1 Receptacle, 1 Smart USB-A+C Charging, 2 Data Ports, 1 Cable Bay	Q, T	EUC2-PJ0P-101021	1727.08
				1 Receptacle, 1 USB-C 60W Charging, 1 Data Port, 1 Cable Bay	Q, T	EUC2-PJ0P-100111	1982.82
				2 Receptacles, 2 Smart USB-A+C Charging, 1 Cable Bay	Q, T	EUC2-PJ0P-211001	1830.60
				2 Receptacles, 2 Smart USB-A+C Charging, 2 Data Ports	Q, T	EUC2-PJ0P-211020	1830.60
				2 Receptacles, 1 Smart USB-A+C Charging, 3 Data Ports	Q, T	EUC2-PJ0P-201030	1727.08
				2 Receptacles, 1 USB-C 60W Charging, 1 Cable Bay	Q, T	EUC2-PJ0P-200101	1982.82
				2 Receptacles, 1 USB-C 60W Charging, 2 Data Ports	Q, T	EUC2-PJ0P-200120	1982.82
				2 Receptacles, 2 Data Ports, 1 Cable Bay	Q, T	EUC2-PJ0P-200021	1623.56
				2 Receptacles, 4 Data Ports	Q, T	EUC2-PJ0P-200040	1623.56
				3 Receptacles, 1 Data Port, 1 Cable Bay	Q, T	EUC2-PJ0P-300011	1623.56
				3 Receptacles, 2 Smart USB-A+C Charging, 1 Data Port	Q, T	EUC2-PJ0P-311010	1830.60
				3 Receptacles, 1 Smart USB-A+C Charging, 1 Cable Bay	Q, T	EUC2-PJ0P-301001	1727.08
				3 Receptacles, 1 Smart USB-A+C Charging, 2 Data Ports	Q, T	EUC2-PJ0P-301020	1727.08
				3 Receptacles, 1 USB-C 60W Charging, 1 Data Port	Q, T	EUC2-PJ0P-300110	1982.82
				3 Receptacles, 3 Data Ports	Q, T	EUC2-PJ0P-300030	1623.56
				4 Receptacles, 2 Dual USB-A Charging	Q, T	EUC2-PJ0P-420000	1830.60
				4 Receptacles, 1 Cable Bay	Q, T	EUC2-PJ0P-400001	1623.56
				4 Receptacles, 1 Smart USB-A+C Charging, 1 Data Port	Q, T	EUC2-PJ0P-401010	1727.08
				4 Receptacles, 1 USB-C 60W Charging	Q, T	EUC2-PJ0P-400100	1982.82
				4 Receptacles, 2 Data Ports	Q, T	EUC2-PJ0P-400020	1623.56
				4 Receptacles, 2 Smart USB-A+C Charging	Q, T	EUC2-PJ0P-402000	1830.60
				5 Receptacles, 1 Data Port	Q, T	EUC2-PJ0P-500010	1623.56
				5 Receptacles, 1 Smart USB-A+C Charging	Q, T	EUC2-PJ0P-501000	1727.08
				6 Receptacles	Q, T	EUC2-PJ0P-600000	1623.56

This page intentionally blank

Electrical Components

Flip Top Unit with Smooth Bezel — Hardwire — Single-Sided

Power, Data and USB

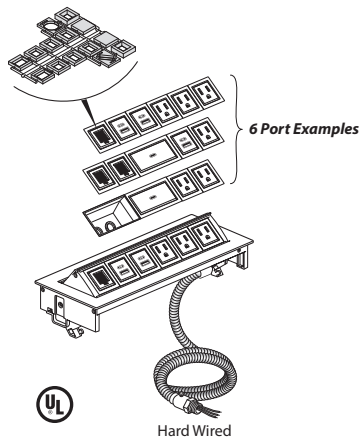

EUC1-HFOP-311010

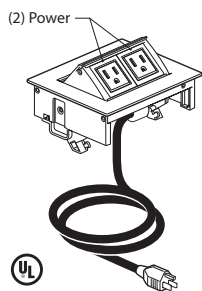

EUC1-HFOP-200000

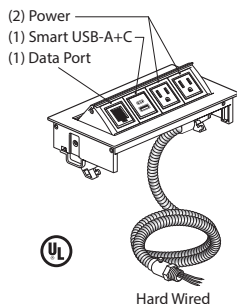

EUC1-HFOP-210010

Features

- Includes flip top with smooth bezel module with 2, 4, or 6 ports configured with simplex outlets (NEMA 5-15R), USB charging port (USB-A, USB-C 60W, Smart USB-A+C), data port(s) or cable bay, and mounting hardware.
- The Smart USB-A+C allows for the 20W to be transferred between the 2 ports. If the USB-A is being used, the full wattage is sent to the USB-A, and the same for the USB-C. If both are being used, the wattage is distributed to each port and the port drawing the most power will receive more watts than the one that is not.
- Data jack adapters accommodate most varieties of field supplied data jacks or separately specified AV cables. Occupies one port.
- Each cable bay can accept up to two pull out data/AV cables. Occupies two ports.
- Smart USB-A+C can provide fast charge for a mobile phone and tablets. Occupies one charging port.
- USB-C 60W can charge phone, tablets and some laptops. Occupies two ports.
- Smooth bezel is painted and features non mitered corners.
- Port color is either black or white based on smooth bezel color.
- Flip top unit is flush mounted with spring release cover.
- Flip top unit overall height is 2.75”(70mm) and will extend below the table top.
- Hardwired power module with 6’(1829mm) or 10’(3048mm) long flexible metal conduit feed, 0.5”(13mm) conduit fitting and wires for hardwire connection.
- Ships assembled.

Specification Tips

- Designed to be used with 1.18”(30mm) and 2”(51mm) thick surfaces with clear space below.
- **Configuration and quantity of ports cannot be modified in the field.**
- **For use with 120 volt 60 hertz power source only.**
- Requires field installation.
- Specify factory cut hole or field cut hole as required.
- Specify AV cables separately.
- Cable Bay requires cables less than 0.3”(7.6mm) diameter.
- Application may require approval of local authority having jurisdiction (AHJ); ensure compliance before placing orders and installation.

To Order, Specify:

- 1) Product number.
- 2) Finish color for Bezel/Port.

TR-PM1	Silver/White
TR-PM2	Midnight Black/Black
TR-PM8	Matte White/White
TR-PM9	Matte Grey/Black

Note: Order flip top units to match flip top unit cutout option specified for each top (A/B, F/V or J/K).

Electrical Components

Flip Top Unit with Smooth Bezel — Hardwire — Single-Sided

Bezel Width	Bezel Depth	Cord Length	Port	Configuration	Flip Top Unit Cutout Code Options	Number	Price
		6' (1829mm)	2	1 Receptacle, 1 Data Port	A, B	EUC1-HF0P-100010	\$ 822.62
				1 Receptacle, 1 Smart USB-A+C Charging	A, B	EUC1-HF0P-101000	926.14
				2 Receptacles	A, B	EUC1-HF0P-200000	822.62
			4	1 Receptacle, 2 Smart USB-A+C Charging, 1 Data Port	F, V	EUC1-HF0P-111010	1058.40
				1 Receptacle, 1 Smart USB-A+C Charging, 1 Cable Bay	F, V	EUC1-HF0P-101001	954.88
				1 Receptacle, 1 USB-C 60W Charging, 1 Data Port	F, V	EUC1-HF0P-100110	1210.62
				2 Receptacles, 1 Cable Bay	F, V	EUC1-HF0P-200001	851.36
				2 Receptacles, 1 USB-C 60W Charging	F, V	EUC1-HF0P-200100	1210.62
				2 Receptacles, 1 Smart USB-A+C Charging, 1 Data Port	F, V	EUC1-HF0P-201010	954.88
				2 Receptacles, 2 Data Ports	F, V	EUC1-HF0P-200020	851.36
				2 Receptacles, 2 Smart USB-A+C Charging	F, V	EUC1-HF0P-202000	1058.40
				3 Receptacles, 1 Data Port	F, V	EUC1-HF0P-300010	851.36
				3 Receptacles, 1 Smart USB-A+C Charging	F, V	EUC1-HF0P-301000	954.88
				4 Receptacles	F, V	EUC1-HF0P-400000	851.36
			6	1 Receptacle, 2 Smart USB-A+C Charging, 1 Data Port, 1 Cable Bay	J, K	EUC1-HF0P-111011	\$1072.77
				1 Receptacle, 1 USB-C 60W Charging, 2 Data Ports	J, K	EUC1-HF0P-110120	1328.51
				1 Receptacle, 1 Smart USB-A+C Charging, 2 Data Ports, 1 Cable Bay	J, K	EUC1-HF0P-101021	969.25
				1 Receptacle, 1 USB-C 60W Charging, 1 Data Port, 1 Cable Bay	J, K	EUC1-HF0P-100111	1224.99
				2 Receptacles, 2 Smart USB-A+C Charging, 1 Cable Bay	J, K	EUC1-HF0P-211001	1072.77
				2 Receptacles, 2 Smart USB-A+C Charging, 2 Data Ports	J, K	EUC1-HF0P-211020	1072.77
				2 Receptacles, 1 Smart USB-A+C Charging, 3 Data Ports	J, K	EUC1-HF0P-201030	969.25
				2 Receptacles, 1 USB-C 60W Charging, 1 Cable Bay	J, K	EUC1-HF0P-200101	1224.99
				2 Receptacles, 1 USB-C 60W Charging, 2 Data Ports	J, K	EUC1-HF0P-200120	1224.99
				2 Receptacles, 2 Data Ports, 1 Cable Bay	J, K	EUC1-HF0P-200021	865.73
				2 Receptacles, 4 Data Ports	J, K	EUC1-HF0P-200040	865.73
				3 Receptacles, 1 Data Port, 1 Cable Bay	J, K	EUC1-HF0P-300011	865.73
				3 Receptacles, 2 Smart USB-A+C Charging, 1 Data Port	J, K	EUC1-HF0P-311010	1072.77
				3 Receptacles, 1 Smart USB-A+C Charging, 1 Cable Bay	J, K	EUC1-HF0P-301001	969.25
				3 Receptacles, 1 Smart USB-A+C Charging, 2 Data Ports	J, K	EUC1-HF0P-301020	969.25
				3 Receptacles, 1 USB-C 60W Charging, 1 Data Port	J, K	EUC1-HF0P-300110	1224.99
				3 Receptacles, 3 Data Ports	J, K	EUC1-HF0P-300030	865.73
				4 Receptacles, 2 Smart USB-A+C Charging	J, K	EUC1-HF0P-402000	1072.77
				4 Receptacles, 1 Cable Bay	J, K	EUC1-HF0P-400001	865.73
				4 Receptacles, 1 Smart USB-A+C Charging, 1 Data Port	J, K	EUC1-HF0P-401010	969.25
				4 Receptacles, 1 USB-C 60W Charging	J, K	EUC1-HF0P-400100	1224.99
				4 Receptacles, 2 Data Ports	J, K	EUC1-HF0P-400020	865.73
				5 Receptacles, 1 Data Port	J, K	EUC1-HF0P-500010	865.73
				5 Receptacles, 1 Smart USB-A+C Charging	J, K	EUC1-HF0P-501000	969.25
				6 Receptacles	J, K	EUC1-HF0P-600000	865.73

Electrical Components

Flip Top Unit with Smooth Bezel — Hardwire — Single-Sided

Bezel Width	Bezel Depth	Cord Length	Port	Configuration	Flip Top Unit Cutout Code Options	Number	Price
		10' (3048mm)	2	1 Receptacle, 1 Data Port	A, B	EUC1-HJ0P-100010	\$ 893.11
				1 Receptacle, 1 Smart USB-A+C Charging	A, B	EUC1-HJ0P-101000	996.63
				2 Receptacles	A, B	EUC1-HJ0P-200000	893.11
			4	1 Receptacle, 2 Smart USB-A+C Charging, 1 Data Port	F, V	EUC1-HJ0P-111010	1128.89
				1 Receptacle, 1 Smart USB-A+C Charging, 1 Cable Bay	F, V	EUC1-HJ0P-101001	1025.37
				1 Receptacle, 1 USB-C 60W Charging, 1 Data Port	F, V	EUC1-HJ0P-100110	1281.11
				2 Receptacles, 1 Cable Bay	F, V	EUC1-HJ0P-200001	921.85
				2 Receptacles, 1 Smart USB-A+C Charging, 1 Data Port	F, V	EUC1-HJ0P-201010	1025.37
				2 Receptacles, 1 USB-C 60W Charging	F, V	EUC1-HJ0P-200100	1281.11
				2 Receptacles, 2 Data Ports	F, V	EUC1-HJ0P-200020	921.85
				2 Receptacles, 2 Smart USB-A+C Charging	F, V	EUC1-HJ0P-202000	1128.89
				3 Receptacles, 1 Data Port	F, V	EUC1-HJ0P-300010	921.85
				3 Receptacles, 1 Smart USB-A+C Charging	F, V	EUC1-HJ0P-301000	1025.37
				4 Receptacles	F, V	EUC1-HJ0P-400000	921.85
			6	1 Receptacle, 2 Smart USB-A+C Charging, 1 Data Port, 1 Cable Bay	J, K	EUC1-HJ0P-111011	\$1143.26
				1 Receptacle, 1 USB-C 60W Charging, 2 Data Ports	J, K	EUC1-HJ0P-110120	1399.00
				1 Receptacle, 1 Smart USB-A+C Charging, 2 Data Ports, 1 Cable Bay	J, K	EUC1-HJ0P-101021	1039.74
				1 Receptacle, 1 USB-C 60W Charging, 1 Data Port, 1 Cable Bay	J, K	EUC1-HJ0P-100111	1295.48
				2 Receptacles, 2 Smart USB-A+C Charging, 1 Cable Bay	J, K	EUC1-HJ0P-211001	1143.26
				2 Receptacles, 2 Smart USB-A+C Charging, 2 Data Ports	J, K	EUC1-HJ0P-211020	1143.26
				2 Receptacles, 1 Smart USB-A+C Charging, 3 Data Ports	J, K	EUC1-HJ0P-201030	1039.74
				2 Receptacles, 1 USB-C 60W Charging, 1 Cable Bay	J, K	EUC1-HJ0P-200101	1295.48
				2 Receptacles, 1 USB-C 60W Charging, 2 Data Ports	J, K	EUC1-HJ0P-200120	1295.48
				2 Receptacles, 2 Data Ports, 1 Cable Bay	J, K	EUC1-HJ0P-200021	936.22
				2 Receptacles, 4 Data Ports	J, K	EUC1-HJ0P-200040	936.22
				3 Receptacles, 1 Data Port, 1 Cable Bay	J, K	EUC1-HJ0P-300011	936.22
				3 Receptacles, 2 Smart USB-A+C Charging, 1 Data Port	J, K	EUC1-HJ0P-311010	1143.26
				3 Receptacles, 1 Smart USB-A+C Charging, 1 Cable Bay	J, K	EUC1-HJ0P-301001	1039.74
				3 Receptacles, 1 Smart USB-A+C Charging, 2 Data Ports	J, K	EUC1-HJ0P-301020	1039.74
				3 Receptacles, 1 USB-C 60W Charging, 1 Data Port	J, K	EUC1-HJ0P-300110	1295.48
				3 Receptacles, 3 Data Ports	J, K	EUC1-HJ0P-300030	936.22
				4 Receptacles, 1 Cable Bay	J, K	EUC1-HJ0P-400001	936.22
				4 Receptacles, 1 Smart USB-A+C Charging, 1 Data Port	J, K	EUC1-HJ0P-401010	1039.74
				4 Receptacles, 1 USB-C 60W Charging	J, K	EUC1-HJ0P-400100	1295.48
				4 Receptacles, 2 Data Ports	J, K	EUC1-HJ0P-400020	936.22
				4 Receptacles, 2 Smart USB-A+C Charging	J, K	EUC1-HJ0P-402000	1143.26
				5 Receptacles, 1 Data Port	J, K	EUC1-HJ0P-500010	936.22
				5 Receptacles, 1 Smart USB-A+C Charging	J, K	EUC1-HJ0P-501000	1039.74
				6 Receptacles	J, K	EUC1-HJ0P-600000	936.22

This page intentionally blank

Electrical Components

Flip Top Unit with Smooth Bezel — Hardwire — Double-Sided

Power, Data and USB

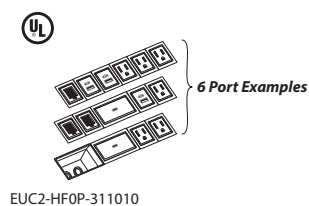
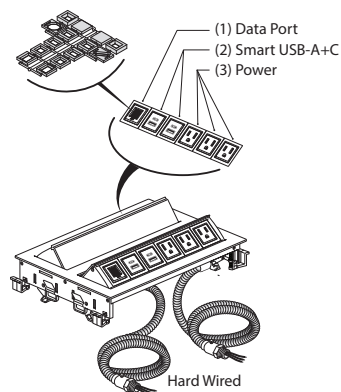

EUC2-HF0P-311010

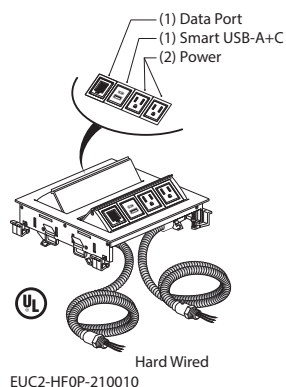

EUC2-HF0P-210010

Features

- Includes double flip top with smooth bezel module with 2, 4, or 6 ports configured with simplex outlets (NEMA 5-15R), USB charging port (USB-C 60W, Smart USB-A+C), data port(s) or cable bay, and mounting hardware.
- The Smart USB-A+C allows for the 20W to be transferred between the 2 ports. If the USB-A is being used, the full wattage is sent to the USB-A, and the same for the USB-C. If both are being used, the wattage is distributed to each port and the port drawing the most power will receive more watts than the one that is not.
- Data jack adapters accommodate most varieties of field supplied data jacks or separately specified AV cables. Occupies one port.
- Each cable bay can accept up to two pull out data/AV cables. Occupies two ports.
- USB-A provides two 10W charging ports. Occupies one port.
- Smart USB-A+C can provide fast charge for a mobile phone and tablets. Occupies one charging port.
- USB-C 60W can charge phone, tablets and some laptops. Occupies two ports.
- Smooth bezel is painted and features non mitered corners.
- Port color is either black or white based on smooth bezel color.
- Flip top unit is flush mounted with spring release cover.
- Flip top unit overall height is 2.75”(70mm) and will extend below the table top.
- Each flip top module within the bezel provided with two 6’(1829mm) or 10’(3048mm) long flexible metal conduit feed, 0.5”(13mm) conduit fitting and wires for hardwire connection.
- Ships assembled.

Specification Tips

- Designed to be used with 1.18”(30mm) and 2”(51mm) thick surfaces with clear space below.
- **Configuration and quantity of ports cannot be modified in the field.**
- **For use with 120 volt 60 hertz power source only.**
- Note two conduit feeds are provided from the double-sided flip top unit.
- Requires field installation.
- Specify factory cut hole or field cut hole as required.
- Specify AV cables separately.
- Cable Bay requires cables less than 0.3”(7.6mm) diameter.
- Application may require approval of local authority having jurisdiction (AHJ); ensure compliance before placing orders and installation.

To Order, Specify:

- 1) Product number.
- 2) Finish color for Bezel/Port.

TR-PM1	Silver/White
TR-PM2	Midnight Black/Black
TR-PM8	Matte White/White
TR-PM9	Matte Grey/Black

Note: Order flip top units to match flip top unit cutout option specified for each top (M/P or Q/V).

Electrical Components

Flip Top Unit with Smooth Bezel — Hardwire — Double-Sided

Bezel Width	Bezel Depth	Cord Length	Port	Configuration	Flip Top Unit Cutout Code Options	Number	Price
		6' (1829mm)	4	1 Receptacle, 2 Smart USB-A+C Charging, 1 Data Port	M, P	EUC2-HF0P-111010	1933.31
				1 Receptacle, 1 Smart USB-A+C Charging, 1 Cable Bay	M, P	EUC2-HF0P-101001	1829.79
				1 Receptacle, 1 USB-C 60W Charging, 1 Data Port	M, P	EUC2-HF0P-100110	2085.53
				2 Receptacles, 1 USB-C 60W Charging	M, P	EUC2-HF0P-200100	2085.53
				2 Receptacles, 1 Cable Bay	M, P	EUC2-HF0P-200001	1726.27
				2 Receptacles, 1 Smart USB-A+C Charging, 1 Data Port	M, P	EUC2-HF0P-201010	1829.79
				2 Receptacles, 2 Data Ports	M, P	EUC2-HF0P-200020	1726.27
				2 Receptacles, 2 Smart USB-A+C Charging	M, P	EUC2-HF0P-202000	1933.31
				3 Receptacles, 1 Data Port	M, P	EUC2-HF0P-300010	1726.27
				3 Receptacles, 1 Smart USB-A+C Charging	M, P	EUC2-HF0P-301000	1829.79
				4 Receptacles	M, P	EUC2-HF0P-400000	1726.27
			6	1 Receptacle, 2 Smart USB-A+C Charging, 1 Data Port, 1 Cable Bay	Q, V	EUC2-HF0P-111011	\$1990.77
				1 Receptacle, 1 USB-C 60W Charging, 2 Data Ports	Q, V	EUC2-HF0P-110120	2246.51
				1 Receptacle, 1 Smart USB-A+C Charging, 2 Data Ports, 1 Cable Bay	Q, V	EUC2-HF0P-101021	1887.25
				1 Receptacle, 1 USB-C 60W Charging, 1 Data Port, 1 Cable Bay	Q, V	EUC2-HF0P-100111	2142.99
				2 Receptacles, 2 Smart USB-A+C Charging, 1 Cable Bay	Q, V	EUC2-HF0P-211001	1990.77
				2 Receptacles, 2 Smart USB-A+C Charging, 2 Data Ports	Q, V	EUC2-HF0P-211020	1990.77
				2 Receptacles, 1 Smart USB-A+C Charging, 3 Data Ports	Q, V	EUC2-HF0P-201030	1887.25
				2 Receptacles, 1 USB-C 60W Charging, 1 Cable Bay	Q, V	EUC2-HF0P-200101	2142.99
				2 Receptacles, 1 USB-C 60W Charging, 2 Data Ports	Q, V	EUC2-HF0P-200120	2142.99
				2 Receptacles, 2 Data Ports, 1 Cable Bay	Q, V	EUC2-HF0P-200021	1783.73
				2 Receptacles, 4 Data Ports	Q, V	EUC2-HF0P-200040	1783.73
				3 Receptacles, 1 Data Port, 1 Cable Bay	Q, V	EUC2-HF0P-300011	1783.73
				3 Receptacles, 2 Smart USB-A+C Charging, 1 Data Port	Q, V	EUC2-HF0P-311010	1990.77
				3 Receptacles, 1 Smart USB-A+C Charging, 1 Cable Bay	Q, V	EUC2-HF0P-301001	1887.25
				3 Receptacles, 1 Smart USB-A+C Charging, 2 Data Ports	Q, V	EUC2-HF0P-301020	1887.25
				3 Receptacles, 1 USB-C 60W Charging, 1 Data Port	Q, V	EUC2-HF0P-300110	2142.99
				3 Receptacles, 3 Data Ports	Q, V	EUC2-HF0P-300030	1783.73
				4 Receptacles, 1 Cable Bay	Q, V	EUC2-HF0P-400001	1783.73
				4 Receptacles, 1 Smart USB-A+C Charging, 1 Data Port	Q, V	EUC2-HF0P-401010	1887.25
				4 Receptacles, 1 USB-C 60W Charging	Q, V	EUC2-HF0P-400100	2142.99
				4 Receptacles, 2 Data Ports	Q, V	EUC2-HF0P-400020	1783.73
				4 Receptacles, 2 Smart USB-A+C Charging	Q, V	EUC2-HF0P-402000	1990.77
				5 Receptacles, 1 Data Port	Q, V	EUC2-HF0P-500010	1783.73
				5 Receptacles, 1 Smart USB-A+C Charging	Q, V	EUC2-HF0P-501000	1887.25
				6 Receptacles	Q, V	EUC2-HF0P-600000	1783.73

Electrical Components

Flip Top Unit with Smooth Bezel — Hardwire — Double-Sided

Bezel Width	Bezel Depth	Cord Length	Port	Configuration	Flip Top Unit Cutout Code Options	Number	Price
		10' (3048mm)	4	1 Receptacle, 2 Smart USB-A+C Charging, 1 Data Port	M, P	EUC2-HJ0P-111010	2003.80
				1 Receptacle, 1 Smart USB-A+C Charging, 1 Cable Bay	M, P	EUC2-HJ0P-101001	1900.28
				1 Receptacle, 1 USB-C 60W Charging, 1 Data Port	M, P	EUC2-HJ0P-100110	2156.02
				2 Receptacles, 1 USB-C 60W Charging	M, P	EUC2-HJ0P-200100	2156.02
				2 Receptacles, 1 Cable Bay	M, P	EUC2-HJ0P-200001	1796.76
				2 Receptacles, 1 Smart USB-A+C Charging, 1 Data Port	M, P	EUC2-HJ0P-201010	1900.28
				2 Receptacles, 2 Data Ports	M, P	EUC2-HJ0P-200020	1796.76
				2 Receptacles, 2 Smart USB-A+C Charging	M, P	EUC2-HJ0P-202000	2003.80
				3 Receptacles, 1 Data Port	M, P	EUC2-HJ0P-300010	1796.76
				3 Receptacles, 1 Smart USB-A+C Charging	M, P	EUC2-HJ0P-301000	1900.28
				4 Receptacles	M, P	EUC2-HJ0P-400000	1796.76
			6	1 Receptacle, 2 Smart USB-A+C Charging, 1 Data Port, 1 Cable Bay	Q, V	EUC2-HJ0P-111011	\$2061.26
				1 Receptacle, 1 USB-C 60W Charging, 2 Data Ports	Q, V	EUC2-HJ0P-110120	2317.00
				1 Receptacle, 1 Smart USB-A+C Charging, 2 Data Ports, 1 Cable Bay	Q, V	EUC2-HJ0P-101021	1957.74
				1 Receptacle, 1 USB-C 60W Charging, 1 Data Port, 1 Cable Bay	Q, V	EUC2-HJ0P-100111	2213.48
				2 Receptacles, 2 Smart USB-A+C Charging, 1 Cable Bay	Q, V	EUC2-HJ0P-211001	2061.26
				2 Receptacles, 2 Smart USB-A+C Charging, 2 Data Ports	Q, V	EUC2-HJ0P-211020	2061.26
				2 Receptacles, 1 Smart USB-A+C Charging, 3 Data Ports	Q, V	EUC2-HJ0P-201030	1957.74
				2 Receptacles, 1 USB-C 60W Charging, 1 Cable Bay	Q, V	EUC2-HJ0P-200101	2213.48
				2 Receptacles, 1 USB-C 60W Charging, 2 Data Ports	Q, V	EUC2-HJ0P-200120	2213.48
				2 Receptacles, 2 Data Ports, 1 Cable Bay	Q, V	EUC2-HJ0P-200021	1854.22
				2 Receptacles, 4 Data Ports	Q, V	EUC2-HJ0P-200040	1854.22
				3 Receptacles, 1 Data Port, 1 Cable Bay	Q, V	EUC2-HJ0P-300011	1854.22
				3 Receptacles, 2 Smart USB-A+C Charging, 1 Data Port	Q, V	EUC2-HJ0P-311010	2061.26
				3 Receptacles, 1 Smart USB-A+C Charging, 1 Cable Bay	Q, V	EUC2-HJ0P-301001	1957.74
				3 Receptacles, 1 Smart USB-A+C Charging, 2 Data Ports	Q, V	EUC2-HJ0P-301020	1957.74
				3 Receptacles, 1 USB-C 60W Charging, 1 Data Port	Q, V	EUC2-HJ0P-300110	2213.48
				3 Receptacles, 3 Data Ports	Q, V	EUC2-HJ0P-300030	1854.22
				4 Receptacles, 1 Cable Bay	Q, V	EUC2-HJ0P-400001	1854.22
				4 Receptacles, 1 Smart USB-A+C Charging, 1 Data Port	Q, V	EUC2-HJ0P-401010	1957.74
				4 Receptacles, 1 USB-C 60W Charging	Q, V	EUC2-HJ0P-400100	2213.48
				4 Receptacles, 2 Smart USB-A+C Charging	Q, V	EUC2-HJ0P-402000	2061.26
				5 Receptacles, 1 Data Port	Q, V	EUC2-HJ0P-500010	1854.22
				5 Receptacles, 1 Smart USB-A+C Charging	Q, V	EUC2-HJ0P-501000	1957.74
				6 Receptacles	Q, V	EUC2-HJ0P-600000	1854.22

This page intentionally blank

Electrical Components

Flip Top Units

Power and Data

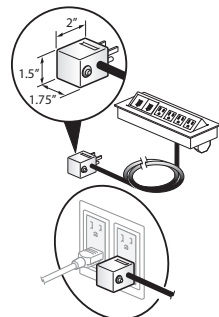
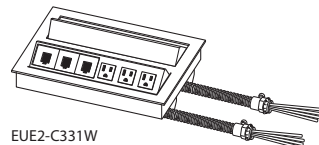
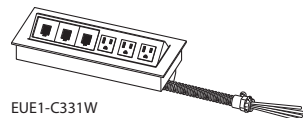
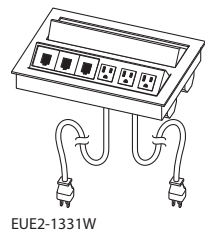
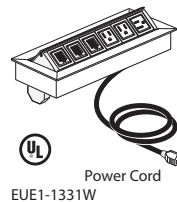
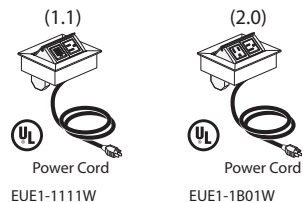

Circuit Breaker Plug Detail

Width	Bezel Depth	Configuration	Number	Price
Corded Single-Sided Outlets				
5.24"(133mm)	4.37"(111mm)	1 Power, 1 Data	EUE1-0000-1111W	\$ 599.80
		2 Power, 0 Data	EUE1-0000-1B01W	599.80
8.31"(211mm)	4.37"(111mm)	2 Power, 2 Data	EUE1-0000-1221W	817.10
		3 Power, 1 Data	EUE1-0000-1311W	817.10
11.25"(286mm)		3 Power, 3 Data	EUE1-0000-1331W	817.10
		4 Power, 2 Data	EUE1-0000-1421W	817.10
Corded Double-Sided Outlets				
8.31"(211mm)	8"(203mm)	2 Power, 2 Data	EUE2-0000-1221W	\$1634.14
		3 Power, 1 Data	EUE2-0000-1311W	1634.14
11.25"(286mm)		3 Power, 3 Data	EUE2-0000-1331W	1634.14
		4 Power, 2 Data	EUE2-0000-1421W	1634.14
Hardwire Single-Sided Outlets				
8.31"(211mm)	4.37"(111mm)	2 Power, 2 Data	EUE1-0000-C221W	\$ 847.83
11.25"(286mm)		3 Power, 3 Data	EUE1-0000-C331W	847.83
Hardwire Double-Sided Outlets				
8.31"(211mm)	8"(203mm)	2 Power, 2 Data	EUE2-0000-C221W	\$1780.20
11.25"(286mm)		3 Power, 3 Data	EUE2-0000-C331W	1780.20

Features

- Hardwire flip top unit includes one flip top unit with power outlets and communication openings, mounting clips, 6 foot flexible metal conduit feed with wires for hardwire, multiple data jack adapters to accommodate most varieties of field supplied data jacks, also includes blank data covers.
- Corded flip top unit includes one flip top unit with power outlets and communication openings, 12 foot long – 15-amp cord with plug, mounting clips, multiple data jack adapters to accommodate most varieties of field supplied data jacks, also includes blank data covers.
- Flip top unit is flush mounted with spring release cover.
- Flip top unit overall height is 2.75"(70mm) and will extend below the table tops.
- Standard in anodized finish.
- Ships assembled.

Specification Tips

- Designed to be used with 1.18"(30mm) and 2"(51mm) thick surfaces with clear space below.
- **For use with 120 volt 60 hertz power source only.**
- Flip top unit plug-in cord drops down from bottom of unit to plug into external power outlet.
- Flip top unit must be field installed on worksurfaces by field cutting hole.
- Application may require approval of local authority having jurisdiction (AHJ); ensure compliance before placing orders and installation.

To Order, Specify:

- 1) Product number.
(No finish specification required.)

Electrical Components

Flip Top Unit — Non-Powered

Width	Bezel Depth	Trim Color	Port Color	Port	Configuration	Number	Price
Single-Sided Outlets							
5.32"(135mm)	4.37"(111mm)	Black Anodized	Black	2	1 Cable Bay	EUE1-000B-0002	\$1102.23
					2 Data Ports	EUE1-000B-0020	1102.23
8.31"(211mm)	4.37"(111mm)			4	2 Data Ports, 1 Cable Bay	EUE1-000B-0022	\$1102.23
					4 Data Ports	EUE1-000B-0040	1102.23
11.3"(287mm)	4.37"(111mm)			6	4 Data Ports, 1 Cable Bay	EUE1-000B-0042	\$1102.23
					6 Data Ports	EUE1-000B-0060	1102.23
5.32"(135mm)	4.37"(111mm)	Clear Anodized	White	2	1 Cable Bay	EUE1-000W-0002	\$ 822.24
					2 Data Ports	EUE1-000W-0020	822.24
8.31"(211mm)	4.37"(111mm)			4	2 Data Ports, 1 Cable Bay	EUE1-000W-0022	\$ 822.24
					4 Data Ports	EUE1-000W-0040	822.24
11.3"(287mm)	4.37"(111mm)			6	4 Data Ports, 1 Cable Bay	EUE1-000W-0042	\$ 822.24
					6 Data Ports	EUE1-000W-0060	822.24
Double-Sided Outlets							
8.31"(211mm)	8.07"(205mm)	Black Anodized	Black	4	2 Data Ports, 1 Cable Bay	EUE2-000B-0022	\$1919.27
					4 Data Ports	EUE2-000B-0040	1919.27
11.3"(287mm)	8.07"(205mm)			6	4 Data Ports, 1 Cable Bay	EUE2-000B-0042	\$1919.27
					6 Data Ports	EUE2-000B-0060	1919.27
8.31"(211mm)	8.07"(205mm)	Clear Anodized	White	4	2 Data Ports, 1 Cable Bay	EUE2-000W-0022	\$1639.28
					4 Data Ports	EUE2-000W-0040	1639.28
11.3"(287mm)	8.07"(205mm)			6	4 Data Ports, 1 Cable Bay	EUE2-000W-0042	\$1639.28
					6 Data Ports	EUE2-000W-0060	1639.28

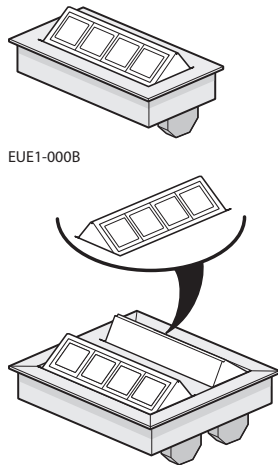

EUE1-000B

EUE2-000B



Features

- Includes bezel and nonpowered flip top module with 2, 4 or 6 ports that can be configured with data ports or cable bays and mounting hardware.
- Data port accommodate most varieties of field supplied data/AV jacks.
- Each Cable Bay can accept up to 2 pull out data/AV cables
- Flip top unit is flush mounted with spring release flip module(s).
- Flip top unit overall height is 2.75"(70mm) and will extend below the table tops.
- Color option of black anodized housing with black receptacles or clear anodized housing with white receptacles.
- Ships assembled.

Specification Tips

- Designed to be used with 1.18"(30mm) and 2"(51mm) thick surfaces with clear space below.
- **Configuration and quantity of power and data ports cannot be modified in the field.**
- Requires field installation.
- Specify factory cut hole or field cut hole as required.
- Specify AV cables separately.
- Cable Bay requires cables less than 0.3"(7.6mm) diameter.
- Application may require approval of local authority having jurisdiction (AHJ); ensure compliance before placing orders and installation.

To Order, Specify:

- 1) Product number.
(No finish specification required.)

Electrical Components

Flip Top Unit – Corded – Single-Sided

Power, Data and USB

4-Port:

- (2) Power
- (1) Smart USB-A+C
- (1) Data

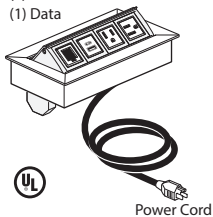

EUE1-PF0B-2110

6-Port:

- (4) Power
- (1) Smart USB-A+C
- (1) Data

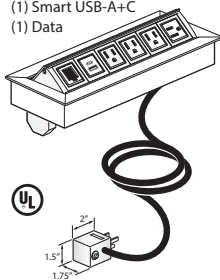

NOTE:
Always Circuit Breaker Plug when more than three power outlets specified.

EUE1-PF0B-1212

4-Port:

- (4) Power

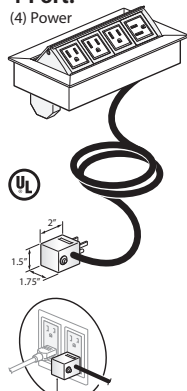

NOTE:
Always Circuit Breaker Plug when more than three power outlets specified.

EUE1-PF0B-4000

Features

- Includes bezel and flip top module with 2, 4 or 6 ports that can be configured with simplex outlets (NEMA-5-15R), USB charging port (Smart USB-A+C), data ports or cable bay(s) that can accept up to 2 pull out data/AV cables and mounting hardware.
- Data port accommodate most varieties of field supplied data/AV jacks.
- Corded power module available with 15 amp - 6'(1829mm) or 12'(3658mm) long cord with plug (NEMA 5-15P).
- The Smart USB-A+C allows for the 20W to be transferred between the 2 ports. If the USB-A is being used, the full wattage is sent to the USB-A, and the same for the USB-C. If both are being used, the wattage is distributed to each port and the port drawing the most power will receive more watts than the one that is not.
- Flip top unit is flush mounted with spring release flip module.
- Flip top unit overall height is 2.75"(70mm) and will extend below the table tops.
- Color option of black anodized housing with black receptacles or clear anodized housing with white receptacles.
- Ships assembled.

Specification Tips

- Designed to be used with 1.18"(30mm) and 2"(51mm) thick surfaces with clear space below.
- **Configuration and quantity of power and data ports cannot be modified in the field.**
- **For use with 120 volt 60 hertz power source only.**
- Requires field installation.
- Specify factory cut hole or field cut hole as required.
- Specify AV cables separately.
- Cable Bay requires cables less than 0.3"(7.6mm) diameter.
- Application may require approval of local authority having jurisdiction (AHJ); ensure compliance before placing orders and installation.

To Order, Specify:

- 1) Product number.
(No finish specification required.)

Note: Order flip top units to match flip top unit cutout option specified for each top (A/B, F/V or J/K).

Electrical Components

Flip Top Unit – Corded – Single-Sided

Bezel Width	Bezel Depth	Cord Length	Trim Color	Port Color	Port	Configuration	Flip Top Unit								
							Cutout Code Options	Number	Price						
5.31" (135mm)	4.37" (111mm)	6' (1829mm)	Black Anodized	Black	2	1 Power Receptacle, 1 Data Port	A, B	EUE1-PF0B-1010	\$1102.23						
						1 Power Receptacle, 1 Smart USB-A+C Charging	A, B	EUE1-PF0B-1100	1205.75						
						2 Power Receptacles	A, B	EUE1-PF0B-2000	1102.23						
8.31" (211mm)	4.37" (111mm)				4	1 Power Receptacle, 1 Data Port, 1 Cable Bay	F, V	EUE1-PF0B-1012	\$1102.23						
						1 Power Receptacle, 3 Data Ports	F, V	EUE1-PF0B-1030	1102.23						
						1 Power Receptacle, 1 Smart USB-A+C Charging, 1 Cable Bay	F, V	EUE1-PF0B-1102	1205.75						
						1 Power Receptacle, 1 Smart USB-A+C Charging, 2 Data Ports	F, V	EUE1-PF0B-1120	1205.75						
						1 Power Receptacle, 3 Smart USB-A+C Charging	F, V	EUE1-PF0B-1300	1412.79						
						2 Power Receptacles, 1 Cable Bay	F, V	EUE1-PF0B-2002	1102.23						
						2 Power Receptacles, 2 Data Ports	F, V	EUE1-PF0B-2020	1102.23						
						2 Power Receptacles, 1 Smart USB-A+C Charging, 1 Data Port	F, V	EUE1-PF0B-2110	1205.75						
						2 Power Receptacles, 2 Smart USB-A+C Charging	F, V	EUE1-PF0B-2200	1309.27						
						3 Power Receptacles, 1 Data Port	F, V	EUE1-PF0B-3010	1102.23						
						3 Power Receptacles, 1 Smart USB-A+C Charging	F, V	EUE1-PF0B-3100	1205.75						
						4 Power Receptacles	F, V	EUE1-PF0B-4000	1102.23						
						11.3" (287mm)	4.37" (111mm)				6	1 Power Receptacle, 3 Data Ports, 1 Cable Bay	J, K	EUE1-PF0B-1032	\$1102.23
												1 Power Receptacle, 5 Data Ports	J, K	EUE1-PF0B-1050	1102.23
												1 Power Receptacle, 1 Smart USB-A+C Charging, 2 Data Ports, 1 Cable Bay	J, K	EUE1-PF0B-1122	1205.75
1 Power Receptacle, 1 Smart USB-A+C Charging, 4 Data Ports	J, K	EUE1-PF0B-1140	1205.75												
1 Power Receptacle, 2 Smart USB-A+C Charging, 1 Data Port, 1 Cable Bay	J, K	EUE1-PF0B-1212	1309.27												
1 Power Receptacle, 2 Smart USB-A+C Charging, 3 Data Ports	J, K	EUE1-PF0B-1230	1309.27												
1 Power Receptacle, 3 Smart USB-A+C Charging, 1 Cable Bay	J, K	EUE1-PF0B-1302	1412.79												
1 Power Receptacle, 3 Smart USB-A+C Charging, 2 Data Ports	J, K	EUE1-PF0B-1320	1412.79												
2 Power Receptacles, 2 Data Ports, 1 Cable Bay	J, K	EUE1-PF0B-2022	1102.23												
2 Power Receptacles, 4 Data Ports	J, K	EUE1-PF0B-2040	1102.23												
2 Power Receptacles, 1 Smart USB-A+C Charging, 1 Data Port, 1 Cable Bay	J, K	EUE1-PF0B-2112	1205.75												
2 Power Receptacles, 1 Smart USB-A+C Charging, 3 Data Ports	J, K	EUE1-PF0B-2130	1205.75												
2 Power Receptacles, 2 Smart USB-A+C Charging, 1 Cable Bay	J, K	EUE1-PF0B-2202	1309.27												
2 Power Receptacles, 2 Smart USB-A+C Charging, 2 Data Ports	J, K	EUE1-PF0B-2220	1309.27												
2 Power Receptacles, 3 Smart USB-A+C Charging, 1 Data Port	J, K	EUE1-PF0B-2310	1412.79												
2 Power Receptacles, 4 Smart USB-A+C Charging	J, K	EUE1-PF0B-2400	1516.31												
3 Power Receptacles, 1 Data Port, 1 Cable Bay	J, K	EUE1-PF0B-3012	1102.23												
3 Power Receptacles, 3 Data Ports	J, K	EUE1-PF0B-3030	1102.23												
3 Power Receptacles, 1 Smart USB-A+C Charging, 1 Cable Bay	J, K	EUE1-PF0B-3102	1205.75												
3 Power Receptacles, 1 Smart USB-A+C Charging, 2 Data Ports	J, K	EUE1-PF0B-3120	1205.75												
3 Power Receptacles, 2 Smart USB-A+C Charging, 1 Data Port	J, K	EUE1-PF0B-3210	1309.27												
3 Power Receptacles, 3 Smart USB-A+C Charging	J, K	EUE1-PF0B-3300	1412.79												
4 Power Receptacles, 1 Cable Bay	J, K	EUE1-PF0B-4002	1102.23												
4 Power Receptacles, 2 Data Ports	J, K	EUE1-PF0B-4020	1102.23												
4 Power Receptacles, 1 Smart USB-A+C Charging, 1 Data Port	J, K	EUE1-PF0B-4110	1205.75												
4 Power Receptacles, 2 Smart USB-A+C Charging	J, K	EUE1-PF0B-4200	1309.27												
5 Power Receptacles, 1 Data Port	J, K	EUE1-PF0B-5010	1102.23												
5 Power Receptacles, 1 Smart USB-A+C Charging	J, K	EUE1-PF0B-5100	1205.75												
6 Power Receptacles	J, K	EUE1-PF0B-6000	1102.23												

Electrical Components

Flip Top Unit – Corded – Single-Sided

Bezel Width	Bezel Depth	Cord Length	Trim Color	Port Color	Port	Configuration	Flip Top Unit Cutout Code Options	Number	Price						
5.31" (135mm)	4.37" (111mm)	6' (1829mm)	Clear Anodized	White	2	1 Power Receptacle, 1 Data Port	A, B	EUE1-PFOW-1010	\$ 822.24						
						1 Power Receptacle, 1 Smart USB-A+C Charging	A, B	EUE1-PFOW-1100	925.76						
						2 Power Receptacles	A, B	EUE1-PFOW-2000	822.24						
8.31" (211mm)	4.37" (111mm)				4	1 Power Receptacle, 1 Data Port, 1 Cable Bay	F, V	EUE1-PFOW-1012	\$ 822.24						
						1 Power Receptacle, 3 Data Ports	F, V	EUE1-PFOW-1030	822.24						
						1 Power Receptacle, 1 Smart USB-A+C Charging, 1 Cable Bay	F, V	EUE1-PFOW-1102	925.76						
						1 Power Receptacle, 1 Smart USB-A+C Charging, 2 Data Ports	F, V	EUE1-PFOW-1120	925.76						
						1 Power Receptacle, 3 Smart USB-A+C Charging	F, V	EUE1-PFOW-1300	1132.80						
						2 Power Receptacles, 1 Cable Bay	F, V	EUE1-PFOW-2002	822.24						
						2 Power Receptacles, 2 Data Ports	F, V	EUE1-PFOW-2020	822.24						
						2 Power Receptacles, 1 Smart USB-A+C Charging, 1 Data Port	F, V	EUE1-PFOW-2110	925.76						
						2 Power Receptacles, 2 Smart USB-A+C Charging	F, V	EUE1-PFOW-2200	1029.28						
						3 Power Receptacles, 1 Data Port	F, V	EUE1-PFOW-3010	822.24						
						3 Power Receptacles, 1 Smart USB-A+C Charging	F, V	EUE1-PFOW-3100	925.76						
						4 Power Receptacles	F, V	EUE1-PFOW-4000	822.24						
						11.3" (287mm)	4.37" (111mm)				6	1 Power Receptacle, 3 Data Ports, 1 Cable Bay	J, K	EUE1-PFOW-1032	\$ 822.24
												1 Power Receptacle, 5 Data Ports	J, K	EUE1-PFOW-1050	822.24
1 Power Receptacle, 1 Smart USB-A+C Charging, 2 Data Ports, 1 Cable Bay	J, K	EUE1-PFOW-1122	925.76												
1 Power Receptacle, 1 Smart USB-A+C Charging, 4 Data Ports	J, K	EUE1-PFOW-1140	925.76												
1 Power Receptacle, 2 Smart USB-A+C Charging, 1 Data Port, 1 Cable Bay	J, K	EUE1-PFOW-1212	1029.28												
1 Power Receptacle, 2 Smart USB-A+C Charging, 3 Data Ports	J, K	EUE1-PFOW-1230	1029.28												
1 Power Receptacle, 3 Smart USB-A+C Charging, 1 Cable Bay	J, K	EUE1-PFOW-1302	1132.80												
1 Power Receptacle, 3 Smart USB-A+C Charging, 2 Data Ports	J, K	EUE1-PFOW-1320	1132.80												
2 Power Receptacles, 2 Data Ports, 1 Cable Bay	J, K	EUE1-PFOW-2022	822.24												
2 Power Receptacles, 4 Data Ports	J, K	EUE1-PFOW-2040	822.24												
2 Power Receptacles, 1 Smart USB-A+C Charging, 1 Data Port, 1 Cable Bay	J, K	EUE1-PFOW-2112	925.76												
2 Power Receptacles, 1 Smart USB-A+C Charging, 3 Data Ports	J, K	EUE1-PFOW-2130	925.76												
2 Power Receptacles, 2 Smart USB-A+C Charging, 1 Cable Bay	J, K	EUE1-PFOW-2202	1029.28												
2 Power Receptacles, 2 Smart USB-A+C Charging, 2 Data Ports	J, K	EUE1-PFOW-2220	1029.28												
2 Power Receptacles, 3 Smart USB-A+C Charging, 1 Data Port	J, K	EUE1-PFOW-2310	1132.80												
2 Power Receptacles, 4 Smart USB-A+C Charging	J, K	EUE1-PFOW-2400	1236.32												
3 Power Receptacles, 1 Data Port, 1 Cable Bay	J, K	EUE1-PFOW-3012	822.24												
3 Power Receptacles, 3 Data Ports	J, K	EUE1-PFOW-3030	822.24												
3 Power Receptacles, 1 Smart USB-A+C Charging, 1 Cable Bay	J, K	EUE1-PFOW-3102	925.76												
3 Power Receptacles, 1 Smart USB-A+C Charging, 2 Data Ports	J, K	EUE1-PFOW-3120	925.76												
3 Power Receptacles, 2 Smart USB-A+C Charging, 1 Data Port	J, K	EUE1-PFOW-3210	1029.28												
3 Power Receptacles, 3 Smart USB-A+C Charging	J, K	EUE1-PFOW-3300	1132.80												
4 Power Receptacles, 1 Cable Bay	J, K	EUE1-PFOW-4002	822.24												
4 Power Receptacles, 2 Data Ports	J, K	EUE1-PFOW-4020	822.24												
4 Power Receptacles, 1 Smart USB-A+C Charging, 1 Data Port	J, K	EUE1-PFOW-4110	925.76												
4 Power Receptacles, 2 Smart USB-A+C Charging	J, K	EUE1-PFOW-4200	1029.28												
5 Power Receptacles, 1 Data Port	J, K	EUE1-PFOW-5010	822.24												
5 Power Receptacles, 1 Smart USB-A+C Charging	J, K	EUE1-PFOW-5100	925.76												
6 Power Receptacles	J, K	EUE1-PFOW-6000	822.24												

Electrical Components

Flip Top Unit – Corded – Single-Sided

Bezel Width	Bezel Depth	Cord Length	Trim Color	Port Color	Port	Configuration	Flip Top Unit								
							Cutout Code Options	Number	Price						
5.31" (135mm)	4.37" (111mm)	12' (3658mm)	Black Anodized	Black	2	1 Power Receptacle, 1 Data Port	A, B	EUE1-PL0B-1010	\$1186.83						
						1 Power Receptacle, 1 Smart USB-A+C Charging	A, B	EUE1-PL0B-1100	1290.35						
						2 Power Receptacles	A, B	EUE1-PL0B-2000	1186.83						
8.31" (211mm)	4.37" (111mm)				4	1 Power Receptacle, 1 Data Port, 1 Cable Bay	F, V	EUE1-PL0B-1012	\$1186.83						
						1 Power Receptacle, 3 Data Ports	F, V	EUE1-PL0B-1030	1186.83						
						1 Power Receptacle, 1 Smart USB-A+C Charging, 1 Cable Bay	F, V	EUE1-PL0B-1102	1290.35						
						1 Power Receptacle, 1 Smart USB-A+C Charging, 2 Data Ports	F, V	EUE1-PL0B-1120	1290.35						
						1 Power Receptacle, 3 Smart USB-A+C Charging	F, V	EUE1-PL0B-1300	1497.39						
						2 Power Receptacles, 1 Cable Bay	F, V	EUE1-PL0B-2002	1186.83						
						2 Power Receptacles, 2 Data Ports	F, V	EUE1-PL0B-2020	1186.83						
						2 Power Receptacles, 1 Smart USB-A+C Charging, 1 Data Port	F, V	EUE1-PL0B-2110	1290.35						
						2 Power Receptacles, 2 Smart USB-A+C Charging	F, V	EUE1-PL0B-2200	1393.87						
						3 Power Receptacles, 1 Data Port	F, V	EUE1-PL0B-3010	1186.83						
						3 Power Receptacles, 1 Smart USB-A+C Charging	F, V	EUE1-PL0B-3100	1290.35						
						4 Power Receptacles	F, V	EUE1-PL0B-4000	1186.83						
						11.3" (287mm)	4.37" (111mm)				6	1 Power Receptacle, 3 Data Ports, 1 Cable Bay	J, K	EUE1-PL0B-1032	\$1186.83
												1 Power Receptacle, 5 Data Ports	J, K	EUE1-PL0B-1050	1186.83
												1 Power Receptacle, 1 Smart USB-A+C Charging, 2 Data Ports, 1 Cable Bay	J, K	EUE1-PL0B-1122	1290.35
1 Power Receptacle, 1 Smart USB-A+C Charging, 4 Data Ports	J, K	EUE1-PL0B-1140	1290.35												
1 Power Receptacle, 2 Smart USB-A+C Charging, 1 Data Port, 1 Cable Bay	J, K	EUE1-PL0B-1212	1393.87												
1 Power Receptacle, 2 Smart USB-A+C Charging, 3 Data Ports	J, K	EUE1-PL0B-1230	1393.87												
1 Power Receptacle, 3 Smart USB-A+C Charging, 1 Cable Bay	J, K	EUE1-PL0B-1302	1497.39												
1 Power Receptacle, 3 Smart USB-A+C Charging, 2 Data Ports	J, K	EUE1-PL0B-1320	1497.39												
2 Power Receptacles, 2 Data Ports, 1 Cable Bay	J, K	EUE1-PL0B-2022	1186.83												
2 Power Receptacles, 4 Data Ports	J, K	EUE1-PL0B-2040	1186.83												
2 Power Receptacles, 1 Smart USB-A+C Charging, 1 Data Port, 1 Cable Bay	J, K	EUE1-PL0B-2112	1290.35												
2 Power Receptacles, 1 Smart USB-A+C Charging, 3 Data Ports	J, K	EUE1-PL0B-2130	1290.35												
2 Power Receptacles, 2 Smart USB-A+C Charging, 1 Cable Bay	J, K	EUE1-PL0B-2202	1393.87												
2 Power Receptacles, 2 Smart USB-A+C Charging, 2 Data Ports	J, K	EUE1-PL0B-2220	1393.87												
2 Power Receptacles, 3 Smart USB-A+C Charging, 1 Data Port	J, K	EUE1-PL0B-2310	1497.39												
2 Power Receptacles, 4 Smart USB-A+C Charging	J, K	EUE1-PL0B-2400	1600.91												
3 Power Receptacles, 1 Data Port, 1 Cable Bay	J, K	EUE1-PL0B-3012	1186.83												
3 Power Receptacles, 3 Data Ports	J, K	EUE1-PL0B-3030	1186.83												
3 Power Receptacles, 1 Smart USB-A+C Charging, 1 Cable Bay	J, K	EUE1-PL0B-3102	1290.35												
3 Power Receptacles, 1 Smart USB-A+C Charging, 2 Data Ports	J, K	EUE1-PL0B-3120	1290.35												
3 Power Receptacles, 2 Smart USB-A+C Charging, 1 Data Port	J, K	EUE1-PL0B-3210	1393.87												
3 Power Receptacles, 3 Smart USB-A+C Charging	J, K	EUE1-PL0B-3300	1497.39												
4 Power Receptacles, 1 Cable Bay	J, K	EUE1-PL0B-4002	1186.83												
4 Power Receptacles, 2 Data Ports	J, K	EUE1-PL0B-4020	1186.83												
4 Power Receptacles, 1 Smart USB-A+C Charging, 1 Data Port	J, K	EUE1-PL0B-4110	1290.35												
4 Power Receptacles, 2 Smart USB-A+C Charging	J, K	EUE1-PL0B-4200	1393.87												
5 Power Receptacles, 1 Data Port	J, K	EUE1-PL0B-5010	1186.83												
5 Power Receptacles, 1 Smart USB-A+C Charging	J, K	EUE1-PL0B-5100	1290.35												
6 Power Receptacles	J, K	EUE1-PL0B-6000	1186.83												

Electrical Components

Flip Top Unit – Corded – Single-Sided

Bezel Width	Bezel Depth	Cord Length	Trim Color	Port Color	Port	Configuration	Flip Top Unit Cutout Code Options	Number	Price						
5.31" (135mm)	4.37" (111mm)	12' (3658mm)	Clear Anodized	White	2	1 Power Receptacle, 1 Data Port	A, B	EUE1-PL0W-1010	\$ 906.84						
						1 Power Receptacle, 1 Smart USB-A+C Charging	A, B	EUE1-PL0W-1100	1010.36						
						2 Power Receptacles	A, B	EUE1-PL0W-2000	906.84						
8.31" (211mm)	4.37" (111mm)				4	1 Power Receptacle, 1 Data Port, 1 Cable Bay	F, V	EUE1-PL0W-1012	\$ 906.84						
						1 Power Receptacle, 3 Data Ports	F, V	EUE1-PL0W-1030	906.84						
						1 Power Receptacle, 1 Smart USB-A+C Charging, 1 Cable Bay	F, V	EUE1-PL0W-1102	1010.36						
						1 Power Receptacle, 1 Smart USB-A+C Charging, 2 Data Ports	F, V	EUE1-PL0W-1120	1010.36						
						1 Power Receptacle, 3 Smart USB-A+C Charging	F, V	EUE1-PL0W-1300	1217.40						
						2 Power Receptacles, 1 Cable Bay	F, V	EUE1-PL0W-2002	906.84						
						2 Power Receptacles, 2 Data Ports	F, V	EUE1-PL0W-2020	906.84						
						2 Power Receptacles, 1 Smart USB-A+C Charging, 1 Data Port	F, V	EUE1-PL0W-2110	1010.36						
						2 Power Receptacles, 2 Smart USB-A+C Charging	F, V	EUE1-PL0W-2200	1113.88						
						3 Power Receptacles, 1 Data Port	F, V	EUE1-PL0W-3010	906.84						
						3 Power Receptacles, 1 Smart USB-A+C Charging	F, V	EUE1-PL0W-3100	1010.36						
						4 Power Receptacles	F, V	EUE1-PL0W-4000	906.84						
						11.3" (287mm)	4.37" (111mm)				6	1 Power Receptacle, 3 Data Ports, 1 Cable Bay	J, K	EUE1-PL0W-1032	\$ 906.84
												1 Power Receptacle, 5 Data Ports	J, K	EUE1-PL0W-1050	906.84
1 Power Receptacle, 1 Smart USB-A+C Charging, 2 Data Ports, 1 Cable Bay	J, K	EUE1-PL0W-1122	1010.36												
1 Power Receptacle, 1 Smart USB-A+C Charging, 4 Data Ports	J, K	EUE1-PL0W-1140	1010.36												
1 Power Receptacle, 2 Smart USB-A+C Charging, 1 Data Port, 1 Cable Bay	J, K	EUE1-PL0W-1212	1113.88												
1 Power Receptacle, 2 Smart USB-A+C Charging, 3 Data Ports	J, K	EUE1-PL0W-1230	1113.88												
1 Power Receptacle, 3 Smart USB-A+C Charging, 1 Cable Bay	J, K	EUE1-PL0W-1302	1217.40												
1 Power Receptacle, 3 Smart USB-A+C Charging, 2 Data Ports	J, K	EUE1-PL0W-1320	1217.40												
2 Power Receptacles, 2 Data Ports, 1 Cable Bay	J, K	EUE1-PL0W-2022	906.84												
2 Power Receptacles, 4 Data Ports	J, K	EUE1-PL0W-2040	906.84												
2 Power Receptacles, 1 Smart USB-A+C Charging, 1 Data Port, 1 Cable Bay	J, K	EUE1-PL0W-2112	1010.36												
2 Power Receptacles, 1 Smart USB-A+C Charging, 3 Data Ports	J, K	EUE1-PL0W-2130	1010.36												
2 Power Receptacles, 2 Smart USB-A+C Charging, 1 Cable Bay	J, K	EUE1-PL0W-2202	1113.88												
2 Power Receptacles, 2 Smart USB-A+C Charging, 2 Data Ports	J, K	EUE1-PL0W-2220	1113.88												
2 Power Receptacles, 3 Smart USB-A+C Charging, 1 Data Port	J, K	EUE1-PL0W-2310	1217.40												
2 Power Receptacles, 4 Smart USB-A+C Charging	J, K	EUE1-PL0W-2400	1320.92												
3 Power Receptacles, 1 Data Port, 1 Cable Bay	J, K	EUE1-PL0W-3012	906.84												
3 Power Receptacles, 3 Data Ports	J, K	EUE1-PL0W-3030	906.84												
3 Power Receptacles, 1 Smart USB-A+C Charging, 1 Cable Bay	J, K	EUE1-PL0W-3102	1010.36												
3 Power Receptacles, 1 Smart USB-A+C Charging, 2 Data Ports	J, K	EUE1-PL0W-3120	1010.36												
3 Power Receptacles, 2 Smart USB-A+C Charging, 1 Data Port	J, K	EUE1-PL0W-3210	1113.88												
3 Power Receptacles, 3 Smart USB-A+C Charging	J, K	EUE1-PL0W-3300	1217.40												
4 Power Receptacles, 1 Cable Bay	J, K	EUE1-PL0W-4002	906.84												
4 Power Receptacles, 2 Data Ports	J, K	EUE1-PL0W-4020	906.84												
4 Power Receptacles, 1 Smart USB-A+C Charging, 1 Data Port	J, K	EUE1-PL0W-4110	1010.36												
4 Power Receptacles, 2 Smart USB-A+C Charging	J, K	EUE1-PL0W-4200	1113.88												
5 Power Receptacles, 1 Data Port	J, K	EUE1-PL0W-5010	906.84												
5 Power Receptacles, 1 Smart USB-A+C Charging	J, K	EUE1-PL0W-5100	1010.36												
6 Power Receptacles	J, K	EUE1-PL0W-6000	906.84												

This page intentionally blank

Electrical Components

Flip Top Unit — Corded — Double-Sided

Power, Data and USB

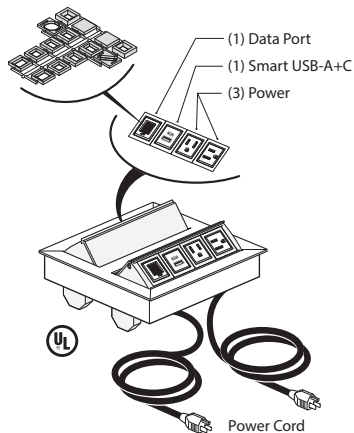

EUE2-PF0B-2110

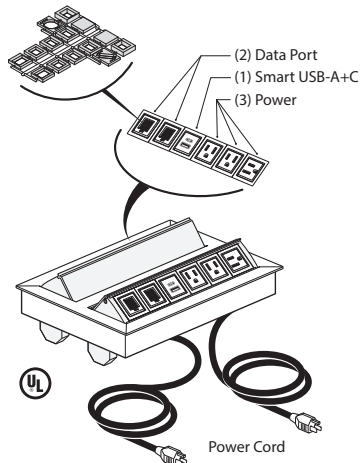

EUE2-PF0B-1212

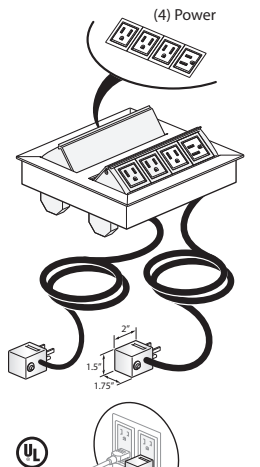

EUE2-PF0B-4000

Features

- Includes bezel and two flip top modules, each flip top module with 2, 4 or 6 ports that can be configured with simplex outlets (NEMA-5-15R), USB charging port (Smart USB-A+C) data ports or cable bay(s) that can accept up to 2 pull out data/AV cables and mounting hardware.
- Data port accommodate most varieties of field supplied data/AV jacks.
- Each flip top module within the bezel provided with 15 amp - 6'(1829mm) or 12'(3658mm) long cord with plug (NEMA5-15P).
- The Smart USB-A+C allows for the 20W to be transferred between the 2 ports. If the USB-A is being used, the full wattage is sent to the USB-A, and the same for the USB-C. If both are being used, the wattage is distributed to each port and the port drawing the most power will receive more watts than the one that is not.
- Flip top unit is flush mounted with spring release flip module.
- Flip top unit overall height is 2.75"(70mm) and will extend below the table tops.
- Color option of black anodized housing with black receptacles or clear anodized housing with white receptacles.
- Ships assembled.

Specification Tips

- Designed to be used with 1.18"(30mm) and 2"(51mm) thick surfaces with clear space below.
- **Configuration and quantity of power and data ports cannot be modified in the field.**
- **For use with 120 volt 60 hertz power source only.**
- Requires field installation.
- Specify factory cut hole or field cut hole as required.
- Specify AV cables separately.
- Cable Bay requires cables less than 0.3"(7.6mm) diameter.
- Application may require approval of local authority having jurisdiction (AHJ); ensure compliance before placing orders and installation.

Note: Two cord feeds are provided from the double-sided flip top unit.

To Order, Specify:

- 1) Product number.
(No finish specification required.)

Note: Order flip top units to match flip top unit cutout option specified for each top (M/P or Q/T).

Electrical Components

Flip Top Unit — Corded — Double-Sided

Width	Bezel Depth	Cord Length	Trim Color	Port Color	Port	Configuration	Flip Top Unit		Price						
							Cutout Code	Options							
5.31" (135mm)	8" (203mm)	6' (1829mm)	Black Anodized	Black	4	1 Power Receptacle, 1 Data Port, 1 Cable Bay	M, P	EUE2-PF0B-1012	\$1919.27						
						1 Power Receptacle, 3 Data Ports	M, P	EUE2-PF0B-1030	1919.27						
						1 Power Receptacle, 1 Smart USB-A+C Charging, 1 Cable Bay	M, P	EUE2-PF0B-1102	2022.79						
						1 Power Receptacle, 1 Smart USB-A+C Charging, 2 Data Ports	M, P	EUE2-PF0B-1120	2022.79						
						1 Power Receptacle, 3 Smart USB-A+C Charging	M, P	EUE2-PF0B-1300	2229.83						
						2 Power Receptacles, 1 Cable Bay	M, P	EUE2-PF0B-2002	1919.27						
						2 Power Receptacles, 2 Data Ports	M, P	EUE2-PF0B-2020	1919.27						
						2 Power Receptacles, 1 Smart USB-A+C Charging, 1 Data Port	M, P	EUE2-PF0B-2110	2022.79						
						2 Power Receptacles, 2 Smart USB-A+C Charging	M, P	EUE2-PF0B-2200	2126.31						
						3 Power Receptacles, 1 Data Port	M, P	EUE2-PF0B-3010	1919.27						
						3 Power Receptacles, 1 Smart USB-A+C Charging	M, P	EUE2-PF0B-3100	2022.79						
						4 Power Receptacles	M, P	EUE2-PF0B-4000	1919.27						
						6						1 Power Receptacle, 3 Data Ports, 1 Cable Bay	Q, T	EUE2-PF0B-1032	\$1919.27
												1 Power Receptacle, 5 Data Ports	Q, T	EUE2-PF0B-1050	1919.27
												1 Power Receptacle, 1 Smart USB-A+C Charging, 2 Data Ports, 1 Cable Bay	Q, T	EUE2-PF0B-1122	2022.79
												1 Power Receptacle, 1 Smart USB-A+C Charging, 4 Data Ports	Q, T	EUE2-PF0B-1140	2022.79
												1 Power Receptacle, 2 Smart USB-A+C Charging, 1 Data Port, 1 Cable Bay	Q, T	EUE2-PF0B-1212	2126.31
												1 Power Receptacle, 2 Smart USB-A+C Charging, 3 Data Ports	Q, T	EUE2-PF0B-1230	2126.31
												1 Power Receptacle, 3 Smart USB-A+C Charging, 2 Cable Bays	Q, T	EUE2-PF0B-1302	2229.83
												1 Power Receptacle, 3 Smart USB-A+C Charging, 2 Data Ports	Q, T	EUE2-PF0B-1320	2229.83
2 Power Receptacles, 2 Data Ports, 2 Cable Bays	Q, T	EUE2-PF0B-2022	1919.27												
2 Power Receptacles, 4 Data Ports	Q, T	EUE2-PF0B-2040	1919.27												
2 Power Receptacles, 1 Smart USB-A+C Charging, 1 Data Port, 2 Cable Bays	Q, T	EUE2-PF0B-2112	2022.79												
2 Power Receptacles, 1 Smart USB-A+C Charging, 3 Data Ports	Q, T	EUE2-PF0B-2130	2022.79												
2 Power Receptacles, 2 Smart USB-A+C Charging, 2 Cable Bays	Q, T	EUE2-PF0B-2202	2126.31												
2 Power Receptacles, 2 Smart USB-A+C Charging, 2 Data Ports	Q, T	EUE2-PF0B-2220	2126.31												
2 Power Receptacles, 3 Smart USB-A+C Charging, 1 Data Port	Q, T	EUE2-PF0B-2310	2229.83												
2 Power Receptacles, 4 Smart USB-A+C Charging	Q, T	EUE2-PF0B-2400	2333.35												
3 Power Receptacles, 1 Data Port, 2 Cable Bays	Q, T	EUE2-PF0B-3012	1919.27												
3 Power Receptacles, 3 Data Ports	Q, T	EUE2-PF0B-3030	1919.27												
3 Power Receptacles, 1 Smart USB-A+C Charging, 2 Cable Bays	Q, T	EUE2-PF0B-3102	2022.79												
3 Power Receptacles, 1 Smart USB-A+C Charging, 2 Data Ports	Q, T	EUE2-PF0B-3120	2022.79												
3 Power Receptacles, 2 Smart USB-A+C Charging, 1 Data Port	Q, T	EUE2-PF0B-3210	2126.31												
3 Power Receptacles, 3 Smart USB-A+C Charging	Q, T	EUE2-PF0B-3300	2229.83												
4 Power Receptacles, 2 Cable Bays	Q, T	EUE2-PF0B-4002	1919.27												
4 Power Receptacles, 2 Data Ports	Q, T	EUE2-PF0B-4020	1919.27												
4 Power Receptacles, 1 Smart USB-A+C Charging, 1 Data Port	Q, T	EUE2-PF0B-4110	2022.79												
4 Power Receptacles, 2 Smart USB-A+C Charging	Q, T	EUE2-PF0B-4200	2126.31												
5 Power Receptacles, 1 Data Port	Q, T	EUE2-PF0B-5010	1919.27												
5 Power Receptacles, 1 Smart USB-A+C Charging	Q, T	EUE2-PF0B-5100	2022.79												
6 Power Receptacles	Q, T	EUE2-PF0B-6000	1919.27												

Electrical Components

Flip Top Unit — Corded — Double-Sided

Width	Bezel Depth	Cord Length	Trim Color	Port Color	Port	Configuration	Flip Top Unit Cutout Code Options	Number	Price
5.31" (135mm)	8" (203mm)	6' (1829mm)	Clear Anodized	White	4	1 Power Receptacle, 1 Data Port, 1 Cable Bay	M, P	EUE2-PF0W-1012	\$1639.28
						1 Power Receptacle, 3 Data Ports	M, P	EUE2-PF0W-1030	1639.28
						1 Power Receptacle, 1 Smart USB-A+C Charging, 1 Cable Bay	M, P	EUE2-PF0W-1102	1742.80
						1 Power Receptacle, 1 Smart USB-A+C Charging, 2 Data Ports	M, P	EUE2-PF0W-1120	1742.80
						1 Power Receptacle, 3 Smart USB-A+C Charging	M, P	EUE2-PF0W-1300	1949.84
						2 Power Receptacles, 1 Cable Bay	M, P	EUE2-PF0W-2002	1639.28
						2 Power Receptacles, 2 Data Ports	M, P	EUE2-PF0W-2020	1639.28
						2 Power Receptacles, 1 Smart USB-A+C Charging, 1 Data Port	M, P	EUE2-PF0W-2110	1742.80
						2 Power Receptacles, 2 Smart USB-A+C Charging	M, P	EUE2-PF0W-2200	1846.32
						3 Power Receptacles, 1 Data Port	M, P	EUE2-PF0W-3010	1639.28
						3 Power Receptacles, 1 Smart USB-A+C Charging	M, P	EUE2-PF0W-3100	1742.80
						4 Power Receptacles	M, P	EUE2-PF0W-4000	1639.28
					6	1 Power Receptacle, 3 Data Ports, 1 Cable Bay	Q, T	EUE2-PF0W-1032	\$1639.28
						1 Power Receptacle, 5 Data Ports	Q, T	EUE2-PF0W-1050	1639.28
						1 Power Receptacle, 1 Smart USB-A+C Charging, 2 Data Ports, 1 Cable Bay	Q, T	EUE2-PF0W-1122	1742.80
						1 Power Receptacle, 1 Smart USB-A+C Charging, 4 Data Ports	Q, T	EUE2-PF0W-1140	1742.80
						1 Power Receptacle, 2 Smart USB-A+C Charging, 1 Data Port, 1 Cable Bay	Q, T	EUE2-PF0W-1212	1846.32
						1 Power Receptacle, 2 Smart USB-A+C Charging, 3 Data Ports	Q, T	EUE2-PF0W-1230	1846.32
						1 Power Receptacle, 3 Smart USB-A+C Charging, 1 Cable Bay	Q, T	EUE2-PF0W-1302	1949.84
						1 Power Receptacle, 3 Smart USB-A+C Charging, 2 Data Ports	Q, T	EUE2-PF0W-1320	1949.84
						2 Power Receptacles, 2 Data Ports, 1 Cable Bay	Q, T	EUE2-PF0W-2022	1639.28
						2 Power Receptacles, 4 Data Ports	Q, T	EUE2-PF0W-2040	1639.28
						2 Power Receptacles, 1 Smart USB-A+C Charging, 1 Data Port, 1 Cable Bay	Q, T	EUE2-PF0W-2112	1742.80
						2 Power Receptacles, 1 Smart USB-A+C Charging, 3 Data Ports	Q, T	EUE2-PF0W-2130	1742.80
						2 Power Receptacles, 2 Smart USB-A+C Charging, 1 Cable Bay	Q, T	EUE2-PF0W-2202	1846.32
						2 Power Receptacles, 2 Smart USB-A+C Charging, 2 Data Ports	Q, T	EUE2-PF0W-2220	1846.32
						2 Power Receptacles, 3 Smart USB-A+C Charging, 1 Data Port	Q, T	EUE2-PF0W-2310	1949.84
						2 Power Receptacles, 4 Smart USB-A+C Charging	Q, T	EUE2-PF0W-2400	2053.36
						3 Power Receptacles, 1 Data Port, 1 Cable Bay	Q, T	EUE2-PF0W-3012	1639.28
						3 Power Receptacles, 3 Data Ports	Q, T	EUE2-PF0W-3030	1639.28
						3 Power Receptacles, 1 Smart USB-A+C Charging, 1 Cable Bay	Q, T	EUE2-PF0W-3102	1742.80
						3 Power Receptacles, 1 Smart USB-A+C Charging, 2 Data Ports	Q, T	EUE2-PF0W-3120	1742.80
						3 Power Receptacles, 2 Smart USB-A+C Charging, 1 Data Port	Q, T	EUE2-PF0W-3210	1846.32
						3 Power Receptacles, 3 Smart USB-A+C Charging	Q, T	EUE2-PF0W-3300	1949.84
						4 Power Receptacles, 1 Cable Bay	Q, T	EUE2-PF0W-4002	1639.28
						4 Power Receptacles, 2 Data Ports	Q, T	EUE2-PF0W-4020	1639.28
						4 Power Receptacles, 1 Smart USB-A+C Charging, 1 Data Port	Q, T	EUE2-PF0W-4110	1742.80
						4 Power Receptacles, 2 Smart USB-A+C Charging	Q, T	EUE2-PF0W-4200	1846.32
						5 Power Receptacles, 1 Data Port	Q, T	EUE2-PF0W-5010	1639.28
						5 Power Receptacles, 1 Smart USB-A+C Charging	Q, T	EUE2-PF0W-5100	1742.80
						6 Power Receptacles	Q, T	EUE2-PF0W-6000	1639.28

Electrical Components

Flip Top Unit — Corded — Double-Sided

Width	Bezel Depth	Cord Length	Trim Color	Port Color	Port	Configuration	Flip Top Unit Cutout Code Options	Number	Price
5.31" (135mm)	8" (203mm)	12' (3658mm)	Black Anodized	Black	4	1 Power Receptacle, 1 Data Port, 1 Cable Bay	M, P	EUE2-PL0B-1012	\$2003.87
						1 Power Receptacle, 3 Data Ports	M, P	EUE2-PL0B-1030	2003.87
						1 Power Receptacle, 1 Smart USB-A+C Charging, 1 Cable Bay	M, P	EUE2-PL0B-1102	2107.39
						1 Power Receptacle, 1 Smart USB-A+C Charging, 2 Data Ports	M, P	EUE2-PL0B-1120	2107.39
						1 Power Receptacle, 3 Smart USB-A+C Charging	M, P	EUE2-PL0B-1300	2314.43
						2 Power Receptacles, 1 Cable Bay	M, P	EUE2-PL0B-2002	2003.87
						2 Power Receptacles, 2 Data Ports	M, P	EUE2-PL0B-2020	2003.87
						2 Power Receptacles, 1 Smart USB-A+C Charging, 1 Data Port	M, P	EUE2-PL0B-2110	2107.39
						2 Power Receptacles, 2 Smart USB-A+C Charging	M, P	EUE2-PL0B-2200	2210.91
						3 Power Receptacles, 1 Data Port	M, P	EUE2-PL0B-3010	2003.87
						3 Power Receptacles, 1 Smart USB-A+C Charging	M, P	EUE2-PL0B-3100	2107.39
						4 Power Receptacles	M, P	EUE2-PL0B-4000	2003.87
					6	1 Power Receptacle, 3 Data Ports, 1 Cable Bay	Q, T	EUE2-PL0B-1032	\$2003.87
						1 Power Receptacle, 5 Data Ports	Q, T	EUE2-PL0B-1050	2003.87
						1 Power Receptacle, 1 Smart USB-A+C Charging, 2 Data Ports, 1 Cable Bay	Q, T	EUE2-PL0B-1122	2107.39
						1 Power Receptacle, 1 Smart USB-A+C Charging, 4 Data Ports	Q, T	EUE2-PL0B-1140	2107.39
						1 Power Receptacle, 2 Smart USB-A+C Charging, 1 Data Port, 1 Cable Bay	Q, T	EUE2-PL0B-1212	2210.91
						1 Power Receptacle, 2 Smart USB-A+C Charging, 3 Data Ports	Q, T	EUE2-PL0B-1230	2210.91
						1 Power Receptacle, 3 Smart USB-A+C Charging, 1 Cable Bay	Q, T	EUE2-PL0B-1302	2314.43
						1 Power Receptacle, 3 Smart USB-A+C Charging, 2 Data Ports	Q, T	EUE2-PL0B-1320	2314.43
						2 Power Receptacles, 2 Data Ports, 1 Cable Bay	Q, T	EUE2-PL0B-2022	2003.87
						2 Power Receptacles, 4 Data Ports	Q, T	EUE2-PL0B-2040	2003.87
						2 Power Receptacles, 1 Smart USB-A+C Charging, 1 Data Port, 1 Cable Bay	Q, T	EUE2-PL0B-2112	2107.39
						2 Power Receptacles, 1 Smart USB-A+C Charging, 3 Data Ports	Q, T	EUE2-PL0B-2130	2107.39
						2 Power Receptacles, 2 Smart USB-A+C Charging, 1 Cable Bay	Q, T	EUE2-PL0B-2202	2210.91
						2 Power Receptacles, 2 Smart USB-A+C Charging, 2 Data Ports	Q, T	EUE2-PL0B-2220	2210.91
						2 Power Receptacles, 3 Smart USB-A+C Charging, 1 Data Port	Q, T	EUE2-PL0B-2310	2314.43
						2 Power Receptacles, 4 Smart USB-A+C Charging	Q, T	EUE2-PL0B-2400	2417.95
						3 Power Receptacles, 1 Data Port, 1 Cable Bay	Q, T	EUE2-PL0B-3012	2003.87
						3 Power Receptacles, 3 Data Ports	Q, T	EUE2-PL0B-3030	2003.87
						3 Power Receptacles, 1 Smart USB-A+C Charging, 1 Cable Bay	Q, T	EUE2-PL0B-3102	2107.39
						3 Power Receptacles, 1 Smart USB-A+C Charging, 2 Data Ports	Q, T	EUE2-PL0B-3120	2107.39
						3 Power Receptacles, 2 Smart USB-A+C Charging, 1 Data Port	Q, T	EUE2-PL0B-3210	2210.91
						3 Power Receptacles, 3 Smart USB-A+C Charging	Q, T	EUE2-PL0B-3300	2314.43
						4 Power Receptacles, 1 Cable Bay	Q, T	EUE2-PL0B-4002	2003.87
						4 Power Receptacles, 2 Data Ports	Q, T	EUE2-PL0B-4020	2003.87
						4 Power Receptacles, 1 Smart USB-A+C Charging, 1 Data Port	Q, T	EUE2-PL0B-4110	2107.39
						4 Power Receptacles, 2 Smart USB-A+C Charging	Q, T	EUE2-PL0B-4200	2210.91
						5 Power Receptacles, 1 Data Port	Q, T	EUE2-PL0B-5010	2003.87
						5 Power Receptacles, 1 Smart USB-A+C Charging	Q, T	EUE2-PL0B-5100	2107.39
						6 Power Receptacles	Q, T	EUE2-PL0B-6000	2003.87

Electrical Components

Flip Top Unit — Corded — Double-Sided

Width	Bezel Depth	Cord Length	Trim Color	Port Color	Port	Configuration	Flip Top Unit Cutout Code Options	Number	Price
5.31" (135mm)	8" (203mm)	12' (3658mm)	Clear Anodized	White	4	1 Power Receptacle, 1 Data Port, 1 Cable Bay	M, P	EUE2-PL0W-1012	\$1723.88
						1 Power Receptacle, 3 Data Ports	M, P	EUE2-PL0W-1030	1723.88
						1 Power Receptacle, 1 Smart USB-A+C Charging, 1 Cable Bay	M, P	EUE2-PL0W-1102	1827.40
						1 Power Receptacle, 1 Smart USB-A+C Charging, 2 Data Ports	M, P	EUE2-PL0W-1120	1827.40
						1 Power Receptacle, 3 Smart USB-A+C Charging	M, P	EUE2-PL0W-1300	2034.44
						2 Power Receptacles, 1 Cable Bay	M, P	EUE2-PL0W-2002	1723.88
						2 Power Receptacles, 2 Data Ports	M, P	EUE2-PL0W-2020	1723.88
						2 Power Receptacles, 1 Smart USB-A+C Charging, 1 Data Port	M, P	EUE2-PL0W-2110	1827.40
						2 Power Receptacles, 2 Smart USB-A+C Charging	M, P	EUE2-PL0W-2200	1930.92
						3 Power Receptacles, 1 Data Port	M, P	EUE2-PL0W-3010	1723.88
						3 Power Receptacles, 1 Smart USB-A+C Charging	M, P	EUE2-PL0W-3100	1827.40
						4 Power Receptacles	M, P	EUE2-PL0W-4000	1723.88
					6	1 Power Receptacle, 3 Data Ports, 1 Cable Bay	Q, T	EUE2-PL0W-1032	\$1723.88
						1 Power Receptacle, 5 Data Ports	Q, T	EUE2-PL0W-1050	1723.88
						1 Power Receptacle, 1 Smart USB-A+C Charging, 2 Data Ports, 1 Cable Bay	Q, T	EUE2-PL0W-1122	1827.40
						1 Power Receptacle, 1 Smart USB-A+C Charging, 4 Data Ports	Q, T	EUE2-PL0W-1140	1827.40
						1 Power Receptacle, 2 Smart USB-A+C Charging, 1 Data Port, 1 Cable Bay	Q, T	EUE2-PL0W-1212	1930.92
						1 Power Receptacle, 2 Smart USB-A+C Charging, 3 Data Ports	Q, T	EUE2-PL0W-1230	1930.92
						1 Power Receptacle, 3 Smart USB-A+C Charging, 1 Cable Bay	Q, T	EUE2-PL0W-1302	2034.44
						1 Power Receptacle, 3 Smart USB-A+C Charging, 2 Data Ports	Q, T	EUE2-PL0W-1320	2034.44
						2 Power Receptacles, 2 Data Ports, 1 Cable Bay	Q, T	EUE2-PL0W-2022	1723.88
						2 Power Receptacles, 4 Data Ports	Q, T	EUE2-PL0W-2040	1723.88
						2 Power Receptacles, 1 Smart USB-A+C Charging, 1 Data Port, 1 Cable Bay	Q, T	EUE2-PL0W-2112	1827.40
						2 Power Receptacles, 1 Smart USB-A+C Charging, 3 Data Ports	Q, T	EUE2-PL0W-2130	1827.40
						2 Power Receptacles, 2 Smart USB-A+C Charging, 1 Cable Bay	Q, T	EUE2-PL0W-2202	1930.92
						2 Power Receptacles, 2 Smart USB-A+C Charging, 2 Data Ports	Q, T	EUE2-PL0W-2220	1930.92
						2 Power Receptacles, 3 Smart USB-A+C Charging, 1 Data Port	Q, T	EUE2-PL0W-2310	2034.44
						2 Power Receptacles, 4 Smart USB-A+C Charging	Q, T	EUE2-PL0W-2400	2137.96
						3 Power Receptacles, 1 Data Port, 1 Cable Bay	Q, T	EUE2-PL0W-3012	1723.88
						3 Power Receptacles, 3 Data Ports	Q, T	EUE2-PL0W-3030	1723.88
						3 Power Receptacles, 1 Smart USB-A+C Charging, 1 Cable Bay	Q, T	EUE2-PL0W-3102	1827.40
						3 Power Receptacles, 1 Smart USB-A+C Charging, 2 Data Ports	Q, T	EUE2-PL0W-3120	1827.40
						3 Power Receptacles, 2 Smart USB-A+C Charging, 1 Data Port	Q, T	EUE2-PL0W-3210	1930.92
						3 Power Receptacles, 3 Smart USB-A+C Charging	Q, T	EUE2-PL0W-3300	2034.44
						4 Power Receptacles, 1 Cable Bay	Q, T	EUE2-PL0W-4002	1723.88
						4 Power Receptacles, 2 Data Ports	Q, T	EUE2-PL0W-4020	1723.88
						4 Power Receptacles, 1 Smart USB-A+C Charging, 1 Data Port	Q, T	EUE2-PL0W-4110	1827.40
						4 Power Receptacles, 2 Smart USB-A+C Charging	Q, T	EUE2-PL0W-4200	1930.92
						5 Power Receptacles, 1 Data Port	Q, T	EUE2-PL0W-5010	1723.88
						5 Power Receptacles, 1 Smart USB-A+C Charging	Q, T	EUE2-PL0W-5100	1827.40
						6 Power Receptacles	Q, T	EUE2-PL0W-6000	1723.88

This page intentionally blank

Electrical Components

Flip Top Unit — Hardwire — Single-Sided

Power, Data and USB

4-Port:

- (2) Power
- (1) Smart USB-A+C
- (1) Data

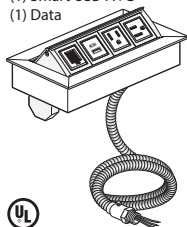

Hard Wired

EUE1-HF0B-2110

6-Port:

- (3) Power
- (1) Smart USB-A+C
- (2) Data

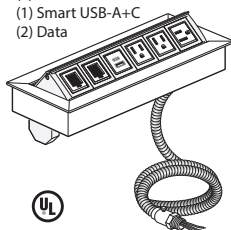

Hard Wired

EUE1-HF0B-1212

Features

- Includes bezel and flip top module with 2, 4 or 6 ports that can be configured with simplex outlets (NEMA-5-15R), USB charging port (Smart USB-A+C), data ports or cable bay(s) that can accept up to 2 pull out data/AV cables and mounting hardware.
- Data port accommodate most varieties of field supplied data/AV jacks.
- Hardwired power module with 6'(1829mm) or 12'(3658mm) long flexible metal conduit feed, 0.5"(13mm) conduit fitting and wires for hardwire connection.
- The Smart USB-A+C allows for the 20W to be transferred between the 2 ports. If the USB-A is being used, the full wattage is sent to the USB-A, and the same for the USB-C. If both are being used, the wattage is distributed to each port and the port drawing the most power will receive more watts than the one that is not.
- Flip top unit is flush mounted with spring release flip module(s).
- Flip top unit overall height is 2.75"(70mm) and will extend below the table tops.
- Color option of black anodized housing with black receptacles or clear anodized housing with white receptacles.

Specification Tips

- Designed to be used with 1.18"(30 mm) and 2"(51mm) thick surfaces with clear space below.
- **Configuration and quantity of power and data ports cannot be modified in the field.**
- **For use with 120 volt 60 hertz power source only.**
- Requires field installation.
- Specify factory cut hole or field cut hole as required.
- Specify AV cables separately.
- Cable Bay requires cables less than 0.3"(7.6mm) diameter.
- Application may require approval of local authority having jurisdiction (AHJ); ensure compliance before placing orders and installation.

To Order, Specify:

- 1) Product number.
(No finish specification required.)

Note: Order flip top units to match flip top unit cutout option specified for each top (A/B, F/V or J/K).

Electrical Components

Flip Top Unit — Hardwire — Single-Sided

Width	Bezel Depth	Cord Length	Trim Color	Port Color	Port	Configuration	Flip Top Unit		Price	
							Cutout Code Options	Number		
5.31" (135mm)	4.37" (111mm)	6' (1829mm)	Black Anodized	Black	2	1 Power Receptacle, 1 Data Port	A, B	EUE1-HF0B-1010	\$1217.56	
						1 Power Receptacle, 1 Smart USB-A+C Charging	A, B	EUE1-HF0B-1100	1321.08	
						2 Power Receptacles	A, B	EUE1-HF0B-2000	1217.56	
						4	1 Power Receptacle, 1 Data Port, 1 Cable Bay	F, V	EUE1-HF0B-1012	\$1217.56
							1 Power Receptacle, 3 Data Ports	F, V	EUE1-HF0B-1030	1217.56
							1 Power Receptacle, 1 Smart USB-A+C Charging, 1 Cable Bay	F, V	EUE1-HF0B-1102	1321.08
						1 Power Receptacle, 1 Smart USB-A+C Charging, 2 Data Ports	F, V	EUE1-HF0B-1120	1321.08	
						1 Power Receptacle, 3 Smart USB-A+C Charging	F, V	EUE1-HF0B-1300	1528.12	
						2 Power Receptacles, 1 Cable Bay	F, V	EUE1-HF0B-2002	1217.56	
						2 Power Receptacles, 2 Data Ports	F, V	EUE1-HF0B-2020	1217.56	
						2 Power Receptacles, 1 Smart USB-A+C Charging, 1 Data Port	F, V	EUE1-HF0B-2110	1321.08	
						2 Power Receptacles, 2 Smart USB-A+C Charging	F, V	EUE1-HF0B-2200	1424.60	
						3 Power Receptacles, 1 Data Port	F, V	EUE1-HF0B-3010	1217.56	
						3 Power Receptacles, 1 Smart USB-A+C Charging	F, V	EUE1-HF0B-3100	1321.08	
						4 Power Receptacles	F, V	EUE1-HF0B-4000	1217.56	
						6	1 Power Receptacle, 3 Data Ports, 1 Cable Bay	J, K	EUE1-HF0B-1032	\$1217.56
							1 Power Receptacle, 5 Data Ports	J, K	EUE1-HF0B-1050	1217.56
							1 Power Receptacle, 1 Smart USB-A+C Charging, 2 Data Ports, 1 Cable Bay	J, K	EUE1-HF0B-1122	1321.08
							1 Power Receptacle, 1 Smart USB-A+C Charging, 4 Data Ports	J, K	EUE1-HF0B-1140	1321.08
							1 Power Receptacle, 2 Smart USB-A+C Charging, 1 Data Port, 1 Cable Bay	J, K	EUE1-HF0B-1212	1424.60
							1 Power Receptacle, 2 Smart USB-A+C Charging, 3 Data Ports	J, K	EUE1-HF0B-1230	1424.60
							1 Power Receptacle, 3 Smart USB-A+C Charging, 1 Cable Bay	J, K	EUE1-HF0B-1302	1528.12
							1 Power Receptacle, 3 Smart USB-A+C Charging, 2 Data Ports	J, K	EUE1-HF0B-1320	1528.12
							2 Power Receptacles, 2 Data Ports, 1 Cable Bay	J, K	EUE1-HF0B-2022	1217.56
							2 Power Receptacles, 4 Data Ports	J, K	EUE1-HF0B-2040	1217.56
							2 Power Receptacles, 1 Smart USB-A+C Charging, 1 Data Port, 1 Cable Bay	J, K	EUE1-HF0B-2112	1321.08
							2 Power Receptacles, 1 Smart USB-A+C Charging, 3 Data Ports	J, K	EUE1-HF0B-2130	1321.08
							2 Power Receptacles, 2 Smart USB-A+C Charging, 1 Cable Bay	J, K	EUE1-HF0B-2202	1424.60
							2 Power Receptacles, 2 Smart USB-A+C Charging, 2 Data Ports	J, K	EUE1-HF0B-2220	1424.60
							2 Power Receptacles, 3 Smart USB-A+C Charging, 1 Data Port	J, K	EUE1-HF0B-2310	1528.12
2 Power Receptacles, 4 Smart USB-A+C Charging	J, K	EUE1-HF0B-2400	1631.64							
3 Power Receptacles, 1 Data Port, 1 Cable Bay	J, K	EUE1-HF0B-3012	1217.56							
3 Power Receptacles, 3 Data Ports	J, K	EUE1-HF0B-3030	1217.56							
3 Power Receptacles, 1 Smart USB-A+C Charging, 1 Cable Bay	J, K	EUE1-HF0B-3102	1321.08							
3 Power Receptacles, 1 Smart USB-A+C Charging, 2 Data Ports	J, K	EUE1-HF0B-3120	1321.08							
3 Power Receptacles, 2 Smart USB-A+C Charging, 1 Data Port	J, K	EUE1-HF0B-3210	1424.60							
3 Power Receptacles, 3 Smart USB-A+C Charging	J, K	EUE1-HF0B-3300	1528.12							
4 Power Receptacles, 1 Cable Bay	J, K	EUE1-HF0B-4002	1217.56							
4 Power Receptacles, 2 Data Ports	J, K	EUE1-HF0B-4020	1217.56							
4 Power Receptacles, 1 Smart USB-A+C Charging, 1 Data Port	J, K	EUE1-HF0B-4110	1321.08							
4 Power Receptacles, 2 Smart USB-A+C Charging	J, K	EUE1-HF0B-4200	1424.60							
5 Power Receptacles, 1 Data Port	J, K	EUE1-HF0B-5010	1217.56							
5 Power Receptacles, 1 Smart USB-A+C Charging	J, K	EUE1-HF0B-5100	1321.08							
6 Power Receptacles	J, K	EUE1-HF0B-6000	1217.56							

Electrical Components

Flip Top Unit — Hardwire — Single-Sided

Width	Bezel Depth	Cord Length	Trim Color	Port Color	Port	Configuration	Flip Top Unit Cutout Code Options	Number	Price
5.31" (135mm)	4.37" (111mm)	6' (1829mm)	Clear Anodized	White	2	1 Power Receptacle, 1 Data Port	A, B	EUE1-HF0W-1010	\$ 937.57
						1 Power Receptacle, 1 Smart USB-A+C Charging	A, B	EUE1-HF0W-1100	1041.09
					4	2 Power Receptacles	A, B	EUE1-HF0W-2000	937.57
						1 Power Receptacle, 1 Data Port, 1 Cable Bay	F, V	EUE1-HF0W-1012	\$ 937.57
					1 Power Receptacle, 3 Data Ports	F, V	EUE1-HF0W-1030	937.57	
					1 Power Receptacle, 1 Smart USB-A+C Charging, 1 Cable Bay	F, V	EUE1-HF0W-1102	1041.09	
					1 Power Receptacle, 1 Smart USB-A+C Charging, 2 Data Ports	F, V	EUE1-HF0W-1120	1041.09	
					1 Power Receptacle, 3 Smart USB-A+C Charging	F, V	EUE1-HF0W-1300	1248.13	
					2 Power Receptacles, 1 Cable Bay	F, V	EUE1-HF0W-2002	937.57	
					2 Power Receptacles, 2 Data Ports	F, V	EUE1-HF0W-2020	937.57	
					2 Power Receptacles, 1 Smart USB-A+C Charging, 1 Data Port	F, V	EUE1-HF0W-2110	1041.09	
					2 Power Receptacles, 2 Smart USB-A+C Charging	F, V	EUE1-HF0W-2200	1144.61	
					3 Power Receptacles, 1 Data Port	F, V	EUE1-HF0W-3010	937.57	
					3 Power Receptacles, 1 Smart USB-A+C Charging	F, V	EUE1-HF0W-3100	1041.09	
					4 Power Receptacles	F, V	EUE1-HF0W-4000	937.57	
					6	1 Power Receptacle, 3 Data Ports, 1 Cable Bay	J, K	EUE1-HF0W-1032	\$ 937.57
						1 Power Receptacle, 5 Data Ports	J, K	EUE1-HF0W-1050	937.57
					1 Power Receptacle, 1 Smart USB-A+C Charging, 2 Data Ports, 1 Cable Bay	J, K	EUE1-HF0W-1122	1041.09	
					1 Power Receptacle, 1 Smart USB-A+C Charging, 4 Data Ports	J, K	EUE1-HF0W-1140	1041.09	
					1 Power Receptacle, 2 Smart USB-A+C Charging, 1 Data Port, 1 Cable Bay	J, K	EUE1-HF0W-1212	1144.61	
					1 Power Receptacle, 2 Smart USB-A+C Charging, 3 Data Ports	J, K	EUE1-HF0W-1230	1144.61	
					1 Power Receptacle, 3 Smart USB-A+C Charging, 1 Cable Bay	J, K	EUE1-HF0W-1302	1248.13	
					1 Power Receptacle, 3 Smart USB-A+C Charging, 2 Data Ports	J, K	EUE1-HF0W-1320	1248.13	
					2 Power Receptacles, 2 Data Ports, 1 Cable Bay	J, K	EUE1-HF0W-2022	937.57	
					2 Power Receptacles, 4 Data Ports	J, K	EUE1-HF0W-2040	937.57	
					2 Power Receptacles, 1 Smart USB-A+C Charging, 1 Data Port, 1 Cable Bay	J, K	EUE1-HF0W-2112	1041.09	
					2 Power Receptacles, 1 Smart USB-A+C Charging, 3 Data Ports	J, K	EUE1-HF0W-2130	1041.09	
					2 Power Receptacles, 2 Smart USB-A+C Charging, 1 Cable Bay	J, K	EUE1-HF0W-2202	1144.61	
					2 Power Receptacles, 2 Smart USB-A+C Charging, 2 Data Ports	J, K	EUE1-HF0W-2220	1144.61	
					2 Power Receptacles, 3 Smart USB-A+C Charging, 1 Data Port	J, K	EUE1-HF0W-2310	1248.13	
					2 Power Receptacles, 4 Smart USB-A+C Charging	J, K	EUE1-HF0W-2400	1351.65	
					3 Power Receptacles, 1 Data Port, 1 Cable Bay	J, K	EUE1-HF0W-3012	937.57	
					3 Power Receptacles, 3 Data Ports	J, K	EUE1-HF0W-3030	937.57	
					3 Power Receptacles, 1 Smart USB-A+C Charging, 1 Cable Bay	J, K	EUE1-HF0W-3102	1041.09	
					3 Power Receptacles, 1 Smart USB-A+C Charging, 2 Data Ports	J, K	EUE1-HF0W-3120	1041.09	
					3 Power Receptacles, 2 Smart USB-A+C Charging, 1 Data Port	J, K	EUE1-HF0W-3210	1144.61	
					3 Power Receptacles, 3 Smart USB-A+C Charging	J, K	EUE1-HF0W-3300	1248.13	
					4 Power Receptacles, 1 Cable Bay	J, K	EUE1-HF0W-4002	937.57	
					4 Power Receptacles, 2 Data Ports	J, K	EUE1-HF0W-4020	937.57	
					4 Power Receptacles, 1 Smart USB-A+C Charging, 1 Data Port	J, K	EUE1-HF0W-4110	1041.09	
4 Power Receptacles, 2 Smart USB-A+C Charging	J, K	EUE1-HF0W-4200	1144.61						
5 Power Receptacles, 1 Data Port	J, K	EUE1-HF0W-5010	937.57						
5 Power Receptacles, 1 Smart USB-A+C Charging	J, K	EUE1-HF0W-5100	1041.09						
6 Power Receptacles	J, K	EUE1-HF0W-6000	937.57						

Electrical Components

Flip Top Unit — Hardwire — Single-Sided

Width	Bezel Depth	Cord Length	Trim Color	Port Color	Port	Configuration	Flip Top Unit Cutout Code Options	Number	Price	
5.31" (135mm)	4.37" (111mm)	12' (3658mm)	Black Anodized	Black	2	1 Power Receptacle, 1 Data Port	A, B	EUE1-HLOB-1010	\$1302.16	
						1 Power Receptacle, 1 Smart USB-A+C Charging	A, B	EUE1-HLOB-1100	1405.68	
						2 Power Receptacles	A, B	EUE1-HLOB-2000	1302.16	
						4	1 Power Receptacle, 1 Data Port, 1 Cable Bay	F, V	EUE1-HLOB-1012	\$1302.16
							1 Power Receptacle, 3 Data Ports	F, V	EUE1-HLOB-1030	1302.16
							1 Power Receptacle, 1 Smart USB-A+C Charging, 1 Cable Bay	F, V	EUE1-HLOB-1102	1405.68
							1 Power Receptacle, 1 Smart USB-A+C Charging, 2 Data Ports	F, V	EUE1-HLOB-1120	1405.68
							1 Power Receptacle, 3 Smart USB-A+C Charging	F, V	EUE1-HLOB-1300	1612.72
							2 Power Receptacles, 1 Cable Bay	F, V	EUE1-HLOB-2002	1302.16
							2 Power Receptacles, 2 Data Ports	F, V	EUE1-HLOB-2020	1302.16
							2 Power Receptacles, 1 Smart USB-A+C Charging, 1 Data Port	F, V	EUE1-HLOB-2110	1405.68
							2 Power Receptacles, 2 Smart USB-A+C Charging	F, V	EUE1-HLOB-2200	1509.20
							3 Power Receptacles, 1 Data Port	F, V	EUE1-HLOB-3010	1302.16
							3 Power Receptacles, 1 Smart USB-A+C Charging	F, V	EUE1-HLOB-3100	1405.68
							4 Power Receptacles	F, V	EUE1-HLOB-4000	1302.16
						6	1 Power Receptacle, 3 Data Ports, 1 Cable Bay	J, K	EUE1-HLOB-1032	\$1302.16
							1 Power Receptacle, 5 Data Ports	J, K	EUE1-HLOB-1050	1302.16
							1 Power Receptacle, 1 Smart USB-A+C Charging, 2 Data Ports, 1 Cable Bay	J, K	EUE1-HLOB-1122	1405.68
							1 Power Receptacle, 1 Smart USB-A+C Charging, 4 Data Ports	J, K	EUE1-HLOB-1140	1405.68
							1 Power Receptacle, 2 Smart USB-A+C Charging, 1 Data Port, 1 Cable Bay	J, K	EUE1-HLOB-1212	1509.20
							1 Power Receptacle, 2 Smart USB-A+C Charging, 3 Data Ports	J, K	EUE1-HLOB-1230	1509.20
							1 Power Receptacle, 3 Smart USB-A+C Charging, 1 Cable Bay	J, K	EUE1-HLOB-1302	1612.72
							1 Power Receptacle, 3 Smart USB-A+C Charging, 2 Data Ports	J, K	EUE1-HLOB-1320	1612.72
							2 Power Receptacles, 2 Data Ports, 1 Cable Bay	J, K	EUE1-HLOB-2022	1302.16
							2 Power Receptacles, 4 Data Ports	J, K	EUE1-HLOB-2040	1302.16
							2 Power Receptacles, 1 Smart USB-A+C Charging, 1 Data Port, 1 Cable Bay	J, K	EUE1-HLOB-2112	1405.68
							2 Power Receptacles, 1 Smart USB-A+C Charging, 3 Data Ports	J, K	EUE1-HLOB-2130	1405.68
							2 Power Receptacles, 2 Smart USB-A+C Charging, 1 Cable Bay	J, K	EUE1-HLOB-2202	1509.20
							2 Power Receptacles, 2 Smart USB-A+C Charging, 2 Data Ports	J, K	EUE1-HLOB-2220	1509.20
							2 Power Receptacles, 3 Smart USB-A+C Charging, 1 Data Port	J, K	EUE1-HLOB-2310	1612.72
2 Power Receptacles, 4 Smart USB-A+C Charging	J, K	EUE1-HLOB-2400	1716.24							
3 Power Receptacles, 1 Data Port, 1 Cable Bay	J, K	EUE1-HLOB-3012	1302.16							
3 Power Receptacles, 3 Data Ports	J, K	EUE1-HLOB-3030	1302.16							
3 Power Receptacles, 1 Smart USB-A+C Charging, 1 Cable Bay	J, K	EUE1-HLOB-3102	1405.68							
3 Power Receptacles, 1 Smart USB-A+C Charging, 2 Data Ports	J, K	EUE1-HLOB-3120	1405.68							
3 Power Receptacles, 2 Smart USB-A+C Charging, 1 Data Port	J, K	EUE1-HLOB-3210	1509.20							
3 Power Receptacles, 3 Smart USB-A+C Charging	J, K	EUE1-HLOB-3300	1612.72							
4 Power Receptacles, 1 Cable Bay	J, K	EUE1-HLOB-4002	1302.16							
4 Power Receptacles, 2 Data Ports	J, K	EUE1-HLOB-4020	1302.16							
4 Power Receptacles, 1 Smart USB-A+C Charging, 1 Data Port	J, K	EUE1-HLOB-4110	1405.68							
4 Power Receptacles, 2 Smart USB-A+C Charging	J, K	EUE1-HLOB-4200	1509.20							
5 Power Receptacles, 1 Data Port	J, K	EUE1-HLOB-5010	1302.16							
5 Power Receptacles, 1 Smart USB-A+C Charging	J, K	EUE1-HLOB-5100	1405.68							
6 Power Receptacles	J, K	EUE1-HLOB-6000	1302.16							

Electrical Components

Flip Top Unit — Hardwire — Single-Sided

Width	Bezel Depth	Cord Length	Trim Color	Port Color	Port	Configuration	Flip Top Unit Cutout Code Options	Number	Price
5.31" (135mm)	4.37" (111mm)	12' (3658mm)	Clear Anodized	White	2	1 Power Receptacle, 1 Data Port	A, B	EUE1-HLOW-1010	\$1022.17
						1 Power Receptacle, 1 Smart USB-A+C Charging	A, B	EUE1-HLOW-1100	1125.69
						2 Power Receptacles	A, B	EUE1-HLOW-2000	1022.17
					4	1 Power Receptacle, 1 Data Port, 1 Cable Bay	F, V	EUE1-HLOW-1012	\$1022.17
						1 Power Receptacle, 3 Data Ports	F, V	EUE1-HLOW-1030	1022.17
						1 Power Receptacle, 1 Smart USB-A+C Charging, 1 Cable Bay	F, V	EUE1-HLOW-1102	1125.69
						1 Power Receptacle, 1 Smart USB-A+C Charging, 2 Data Ports	F, V	EUE1-HLOW-1120	1125.69
						1 Power Receptacle, 3 Smart USB-A+C Charging	F, V	EUE1-HLOW-1300	1332.73
						2 Power Receptacles, 1 Cable Bay	F, V	EUE1-HLOW-2002	1022.17
						2 Power Receptacles, 2 Data Ports	F, V	EUE1-HLOW-2020	1022.17
						2 Power Receptacles, 1 Smart USB-A+C Charging, 1 Data Port	F, V	EUE1-HLOW-2110	1125.69
						2 Power Receptacles, 2 Smart USB-A+C Charging	F, V	EUE1-HLOW-2200	1229.21
						3 Power Receptacles, 1 Data Port	F, V	EUE1-HLOW-3010	1022.17
						3 Power Receptacles, 1 Smart USB-A+C Charging	F, V	EUE1-HLOW-3100	1125.69
						4 Power Receptacles	F, V	EUE1-HLOW-4000	1022.17
					6	1 Power Receptacle, 3 Data Ports, 1 Cable Bay	J, K	EUE1-HLOW-1032	\$1022.17
						1 Power Receptacle, 5 Data Ports	J, K	EUE1-HLOW-1050	1022.17
						1 Power Receptacle, 1 Smart USB-A+C Charging, 2 Data Ports, 1 Cable Bay	J, K	EUE1-HLOW-1122	1125.69
						1 Power Receptacle, 1 Smart USB-A+C Charging, 4 Data Ports	J, K	EUE1-HLOW-1140	1125.69
						1 Power Receptacle, 2 Smart USB-A+C Charging, 1 Data Port, 1 Cable Bay	J, K	EUE1-HLOW-1212	1229.21
						1 Power Receptacle, 2 Smart USB-A+C Charging, 3 Data Ports	J, K	EUE1-HLOW-1230	1229.21
						1 Power Receptacle, 3 Smart USB-A+C Charging, 1 Cable Bay	J, K	EUE1-HLOW-1302	1332.73
						1 Power Receptacle, 3 Smart USB-A+C Charging, 2 Data Ports	J, K	EUE1-HLOW-1320	1332.73
						2 Power Receptacles, 2 Data Ports, 1 Cable Bay	J, K	EUE1-HLOW-2022	1022.17
						2 Power Receptacles, 4 Data Ports	J, K	EUE1-HLOW-2040	1022.17
						2 Power Receptacles, 1 Smart USB-A+C Charging, 1 Data Port, 1 Cable Bay	J, K	EUE1-HLOW-2112	1125.69
						2 Power Receptacles, 1 Smart USB-A+C Charging, 3 Data Ports	J, K	EUE1-HLOW-2130	1125.69
						2 Power Receptacles, 2 Smart USB-A+C Charging, 1 Cable Bay	J, K	EUE1-HLOW-2202	1229.21
						2 Power Receptacles, 2 Smart USB-A+C Charging, 2 Data Ports	J, K	EUE1-HLOW-2220	1229.21
						2 Power Receptacles, 3 Smart USB-A+C Charging, 1 Data Port	J, K	EUE1-HLOW-2310	1332.73
						2 Power Receptacles, 4 Smart USB-A+C Charging	J, K	EUE1-HLOW-2400	1436.25
						3 Power Receptacles, 1 Data Port, 1 Cable Bay	J, K	EUE1-HLOW-3012	1022.17
						3 Power Receptacles, 3 Data Ports	J, K	EUE1-HLOW-3030	1022.17
						3 Power Receptacles, 1 Smart USB-A+C Charging, 1 Cable Bay	J, K	EUE1-HLOW-3102	1125.69
						3 Power Receptacles, 1 Smart USB-A+C Charging, 2 Data Ports	J, K	EUE1-HLOW-3120	1125.69
						3 Power Receptacles, 2 Smart USB-A+C Charging, 1 Data Port	J, K	EUE1-HLOW-3210	1229.21
						3 Power Receptacles, 3 Smart USB-A+C Charging	J, K	EUE1-HLOW-3300	1332.73
						4 Power Receptacles, 1 Cable Bay	J, K	EUE1-HLOW-4002	1022.17
						4 Power Receptacles, 2 Data Ports	J, K	EUE1-HLOW-4020	1022.17
						4 Power Receptacles, 1 Smart USB-A+C Charging, 1 Data Port	J, K	EUE1-HLOW-4110	1125.69
						4 Power Receptacles, 2 Smart USB-A+C Charging	J, K	EUE1-HLOW-4200	1229.21
						5 Power Receptacles, 1 Data Port	J, K	EUE1-HLOW-5010	1022.17
						5 Power Receptacles, 1 Smart USB-A+C Charging	J, K	EUE1-HLOW-5100	1125.69
						6 Power Receptacles	J, K	EUE1-HLOW-6000	1022.17

This page intentionally blank

Electrical Components

Flip Top Unit — Hardwire — Double-Sided

Power, Data and USB

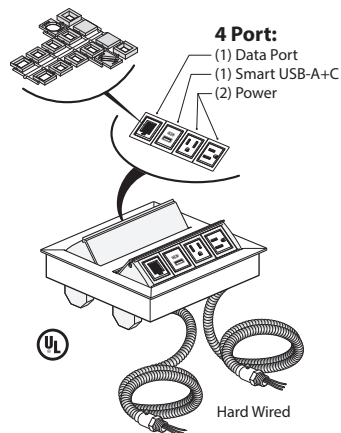

EUE2-HF0B-2110

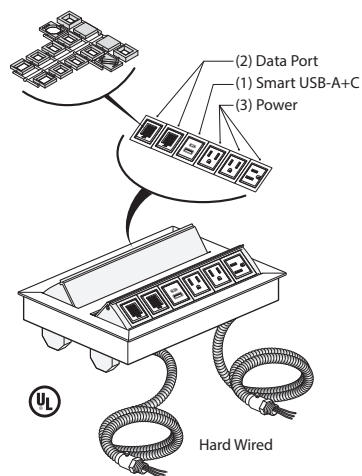

EUE2-HF0B-1212

Features

- Includes bezel and two flip top modules, each with 2, 4 or 6 ports that can be configured with simplex outlets (NEMA-5-15R), USB charging port (Smart USB-A+C), data ports or cable bay(s) that can accept up to 2 pull out data/AV cables and mounting hardware.
- Data port accommodate most varieties of field supplied data/AV jacks.
- Each flip top module within the bezel provided with 6'(1829mm) or 12'(3658mm) long flexible metal conduit feed, 0.5"(13mm) conduit fitting and wires for hardwire connection.
- The Smart USB-A+C allows for the 20W to be transferred between the 2 ports. If the USB-A is being used, the full wattage is sent to the USB-A, and the same for the USB-C. If both are being used, the wattage is distributed to each port and the port drawing the most power will receive more watts than the one that is not.
- Flip top frame is flush mounted with two spring release flip module(s).
- Flip top unit overall height is 2.75"(70mm) and will extend below the table tops.
- Color option of black anodized housing with black receptacles or clear anodized housing with white receptacles.
- Ships assembled.

Specification Tips

- Designed to be used with 1.18"(30mm) and 2"(51mm) thick surfaces with clear space below.
- **Configuration and quantity of power and data ports cannot be modified in the field.**
- **For use with 120 volt 60 hertz power source only.**
- Note two conduit feeds are provided from the double-sided flip top unit.
- Requires field installation.
- Specify factory cut hole or field cut hole as required.
- Specify AV cables separately.
- Cable Bay requires cables less than 0.3"(7.6mm) diameter.
- Application may require approval of local authority having jurisdiction (AHJ); ensure compliance before placing orders and installation.

To Order, Specify:

- 1) Product number.
(No finish specification required.)

Note: Order flip top units to match flip top unit cutout option specified for each top (M/P or Q/V).

Electrical Components

Flip Top Unit — Hardwire — Double-Sided

Width	Bezel Depth	Cord Length	Trim Color	Port Color	Port	Configuration	Flip Top Unit Cutout Code Options	Number	Price
5.31" (135mm)	8" (203mm)	6' (1829mm)	Black Anodized	Black	4	1 Power Receptacle, 1 Data Port, 1 Cable Bay	M, P	EUE2-HF0B-1012	\$2149.93
						1 Power Receptacle, 3 Data Ports	M, P	EUE2-HF0B-1030	2149.93
						1 Power Receptacle, 1 Smart USB-A+C Charging, 1 Cable Bay	M, P	EUE2-HF0B-1102	2253.45
						1 Power Receptacle, 1 Smart USB-A+C Charging, 2 Data Ports	M, P	EUE2-HF0B-1120	2253.45
						1 Power Receptacle, 3 Smart USB-A+C Charging	M, P	EUE2-HF0B-1300	2460.49
						2 Power Receptacles, 1 Cable Bay	M, P	EUE2-HF0B-2002	2149.93
						2 Power Receptacles, 2 Data Ports	M, P	EUE2-HF0B-2020	2149.93
						2 Power Receptacles, 1 Smart USB-A+C Charging, 1 Data Port	M, P	EUE2-HF0B-2110	2253.45
						2 Power Receptacles, 2 Smart USB-A+C Charging	M, P	EUE2-HF0B-2200	2356.97
						3 Power Receptacles, 1 Data Port	M, P	EUE2-HF0B-3010	2149.93
						3 Power Receptacles, 1 Smart USB-A+C Charging	M, P	EUE2-HF0B-3100	2253.45
						4 Power Receptacles	M, P	EUE2-HF0B-4000	2149.93
					6	1 Power Receptacle, 3 Data Ports, 1 Cable Bay	Q, V	EUE2-HF0B-1032	\$2149.93
						1 Power Receptacle, 5 Data Ports	Q, V	EUE2-HF0B-1050	2149.93
						1 Power Receptacle, 1 Smart USB-A+C Charging, 2 Data Ports, 1 Cable Bay	Q, V	EUE2-HF0B-1122	2253.45
						1 Power Receptacle, 1 Smart USB-A+C Charging, 4 Data Ports	Q, V	EUE2-HF0B-1140	2253.45
						1 Power Receptacle, 2 Smart USB-A+C Charging, 1 Data Port, 1 Cable Bay	Q, V	EUE2-HF0B-1212	2356.97
						1 Power Receptacle, 2 Smart USB-A+C Charging, 3 Data Ports	Q, V	EUE2-HF0B-1230	2356.97
						1 Power Receptacle, 3 Smart USB-A+C Charging, 1 Cable Bay	Q, V	EUE2-HF0B-1302	2460.49
						1 Power Receptacle, 3 Smart USB-A+C Charging, 2 Data Ports	Q, V	EUE2-HF0B-1320	2460.49
						2 Power Receptacles, 2 Data Ports, 1 Cable Bay	Q, V	EUE2-HF0B-2022	2149.93
						2 Power Receptacles, 4 Data Ports	Q, V	EUE2-HF0B-2040	2149.93
						2 Power Receptacles, 1 Smart USB-A+C Charging, 1 Data Port, 1 Cable Bay	Q, V	EUE2-HF0B-2112	2253.45
						2 Power Receptacles, 1 Smart USB-A+C Charging, 3 Data Ports	Q, V	EUE2-HF0B-2130	2253.45
						2 Power Receptacles, 2 Smart USB-A+C Charging, 1 Cable Bay	Q, V	EUE2-HF0B-2202	2356.97
						2 Power Receptacles, 2 Smart USB-A+C Charging, 2 Data Ports	Q, V	EUE2-HF0B-2220	2356.97
						2 Power Receptacles, 3 Smart USB-A+C Charging, 1 Data Port	Q, V	EUE2-HF0B-2310	2460.49
						2 Power Receptacles, 4 Smart USB-A+C Charging	Q, V	EUE2-HF0B-2400	2564.01
						3 Power Receptacles, 1 Data Port, 1 Cable Bay	Q, V	EUE2-HF0B-3012	2149.93
						3 Power Receptacles, 3 Data Ports	Q, V	EUE2-HF0B-3030	2149.93
						3 Power Receptacles, 1 Smart USB-A+C Charging, 1 Cable Bay	Q, V	EUE2-HF0B-3102	2253.45
						3 Power Receptacles, 1 Smart USB-A+C Charging, 2 Data Ports	Q, V	EUE2-HF0B-3120	2253.45
						3 Power Receptacles, 2 Smart USB-A+C Charging, 1 Data Port	Q, V	EUE2-HF0B-3210	2356.97
						3 Power Receptacles, 3 Smart USB-A+C Charging	Q, V	EUE2-HF0B-3300	2460.49
						4 Power Receptacles, 1 Cable Bay	Q, V	EUE2-HF0B-4002	2149.93
						4 Power Receptacles, 2 Data Ports	Q, V	EUE2-HF0B-4020	2149.93
						4 Power Receptacles, 1 Smart USB-A+C Charging, 1 Data Port	Q, V	EUE2-HF0B-4110	2253.45
						4 Power Receptacles, 2 Smart USB-A+C Charging	Q, V	EUE2-HF0B-4200	2356.97
						5 Power Receptacles, 1 Data Port	Q, V	EUE2-HF0B-5010	2149.93
						5 Power Receptacles, 1 Smart USB-A+C Charging	Q, V	EUE2-HF0B-5100	2253.45
						6 Power Receptacles	Q, V	EUE2-HF0B-6000	2149.93

Electrical Components

Flip Top Unit — Hardwire — Double-Sided

Width	Bezel Depth	Cord Length	Trim Color	Port Color	Port	Configuration	Flip Top Unit Cutout Code Options	Number	Price
5.31" (135mm)	8" (203mm)	6' (1829mm)	Clear Anodized	White	4	1 Power Receptacle, 1 Data Port, 1 Cable Bay	M, P	EUE2-HF0W-1012	\$1869.94
						1 Power Receptacle, 3 Data Ports	M, P	EUE2-HF0W-1030	1869.94
						1 Power Receptacle, 1 Smart USB-A+C Charging, 1 Cable Bay	M, P	EUE2-HF0W-1102	1973.46
						1 Power Receptacle, 1 Smart USB-A+C Charging, 2 Data Ports	M, P	EUE2-HF0W-1120	1973.46
						1 Power Receptacle, 3 Smart USB-A+C Charging	M, P	EUE2-HF0W-1300	2180.50
						2 Power Receptacles, 1 Cable Bay	M, P	EUE2-HF0W-2002	1869.94
						2 Power Receptacles, 2 Data Ports	M, P	EUE2-HF0W-2020	1869.94
						2 Power Receptacles, 1 Smart USB-A+C Charging, 1 Data Port	M, P	EUE2-HF0W-2110	1973.46
						2 Power Receptacles, 2 Smart USB-A+C Charging	M, P	EUE2-HF0W-2200	2076.98
						3 Power Receptacles, 1 Data Port	M, P	EUE2-HF0W-3010	1869.94
						3 Power Receptacles, 1 Smart USB-A+C Charging	M, P	EUE2-HF0W-3100	1973.46
						4 Power Receptacles	M, P	EUE2-HF0W-4000	1869.94
					6	1 Power Receptacle, 3 Data Ports, 1 Cable Bay	Q, V	EUE2-HF0W-1032	\$1869.94
						1 Power Receptacle, 5 Data Ports	Q, V	EUE2-HF0W-1050	1869.94
						1 Power Receptacle, 1 Smart USB-A+C Charging, 2 Data Ports, 1 Cable Bay	Q, V	EUE2-HF0W-1122	1973.46
						1 Power Receptacle, 1 Smart USB-A+C Charging, 4 Data Ports	Q, V	EUE2-HF0W-1140	1973.46
						1 Power Receptacle, 2 Smart USB-A+C Charging, 1 Data Port, 1 Cable Bay	Q, V	EUE2-HF0W-1212	2076.98
						1 Power Receptacle, 2 Smart USB-A+C Charging, 3 Data Ports	Q, V	EUE2-HF0W-1230	2076.98
						1 Power Receptacle, 3 Smart USB-A+C Charging, 1 Cable Bay	Q, V	EUE2-HF0W-1302	2180.50
						1 Power Receptacle, 3 Smart USB-A+C Charging, 2 Data Ports	Q, V	EUE2-HF0W-1320	2180.50
						2 Power Receptacles, 2 Data Ports, 1 Cable Bay	Q, V	EUE2-HF0W-2022	1869.94
						2 Power Receptacles, 4 Data Ports	Q, V	EUE2-HF0W-2040	1869.94
						2 Power Receptacles, 1 Smart USB-A+C Charging, 1 Data Port, 1 Cable Bay	Q, V	EUE2-HF0W-2112	1973.46
						2 Power Receptacles, 1 Smart USB-A+C Charging, 3 Data Ports	Q, V	EUE2-HF0W-2130	1973.46
						2 Power Receptacles, 2 Smart USB-A+C Charging, 1 Cable Bay	Q, V	EUE2-HF0W-2202	2076.98
						2 Power Receptacles, 2 Smart USB-A+C Charging, 2 Data Ports	Q, V	EUE2-HF0W-2220	2076.98
						2 Power Receptacles, 3 Smart USB-A+C Charging, 1 Data Port	Q, V	EUE2-HF0W-2310	2180.50
						2 Power Receptacles, 4 Smart USB-A+C Charging	Q, V	EUE2-HF0W-2400	2284.02
						3 Power Receptacles, 1 Data Port, 1 Cable Bay	Q, V	EUE2-HF0W-3012	1869.94
						3 Power Receptacles, 3 Data Ports	Q, V	EUE2-HF0W-3030	1869.94
						3 Power Receptacles, 1 Smart USB-A+C Charging, 1 Cable Bay	Q, V	EUE2-HF0W-3102	1973.46
						3 Power Receptacles, 1 Smart USB-A+C Charging, 2 Data Ports	Q, V	EUE2-HF0W-3120	1973.46
						3 Power Receptacles, 2 Smart USB-A+C Charging, 1 Data Port	Q, V	EUE2-HF0W-3210	2076.98
						3 Power Receptacles, 3 Smart USB-A+C Charging	Q, V	EUE2-HF0W-3300	2180.50
						4 Power Receptacles, 1 Cable Bay	Q, V	EUE2-HF0W-4002	1869.94
						4 Power Receptacles, 2 Data Ports	Q, V	EUE2-HF0W-4020	1869.94
						4 Power Receptacles, 1 Smart USB-A+C Charging, 1 Data Port	Q, V	EUE2-HF0W-4110	1973.46
						4 Power Receptacles, 2 Smart USB-A+C Charging	Q, V	EUE2-HF0W-4200	2076.98
						5 Power Receptacles, 1 Data Port	Q, V	EUE2-HF0W-5010	1869.94
						5 Power Receptacles, 1 Smart USB-A+C Charging	Q, V	EUE2-HF0W-5100	1973.46
						6 Power Receptacles	Q, V	EUE2-HF0W-6000	1869.94

Electrical Components

Flip Top Unit — Hardwire — Double-Sided

Width	Bezel Depth	Cord Length	Trim Color	Port Color	Port	Configuration	Flip Top Unit Cutout Code Options	Number	Price
5.31" (135mm)	8" (203mm)	12' (3658mm)	Black Anodized	Black	4	1 Power Receptacle, 1 Data Port, 1 Cable Bay	M, P	EUE2-HLOB-1012	\$2234.53
						1 Power Receptacle, 3 Data Ports	M, P	EUE2-HLOB-1030	2234.53
						1 Power Receptacle, 1 Smart USB-A+C Charging, 1 Cable Bay	M, P	EUE2-HLOB-1102	2338.05
						1 Power Receptacle, 1 Smart USB-A+C Charging, 2 Data Ports	M, P	EUE2-HLOB-1120	2338.05
						1 Power Receptacle, 3 Smart USB-A+C Charging	M, P	EUE2-HLOB-1300	2545.09
						2 Power Receptacles, 1 Cable Bay	M, P	EUE2-HLOB-2002	2234.53
						2 Power Receptacles, 2 Data Ports	M, P	EUE2-HLOB-2020	2234.53
						2 Power Receptacles, 1 Smart USB-A+C Charging, 1 Data Port	M, P	EUE2-HLOB-2110	2338.05
						2 Power Receptacles, 2 Smart USB-A+C Charging	M, P	EUE2-HLOB-2200	2441.57
						3 Power Receptacles, 1 Data Port	M, P	EUE2-HLOB-3010	2234.53
						3 Power Receptacles, 1 Smart USB-A+C Charging	M, P	EUE2-HLOB-3100	2338.05
						4 Power Receptacles	M, P	EUE2-HLOB-4000	2234.53
					6	1 Power Receptacle, 3 Data Ports, 1 Cable Bay	Q, V	EUE2-HLOB-1032	\$2234.53
						1 Power Receptacle, 5 Data Ports	Q, V	EUE2-HLOB-1050	2234.53
						1 Power Receptacle, 1 Smart USB-A+C Charging, 2 Data Ports, 1 Cable Bay	Q, V	EUE2-HLOB-1122	2338.05
						1 Power Receptacle, 1 Smart USB-A+C Charging, 4 Data Ports	Q, V	EUE2-HLOB-1140	2338.05
						1 Power Receptacle, 2 Smart USB-A+C Charging, 1 Data Port, 1 Cable Bay	Q, V	EUE2-HLOB-1212	2441.57
						1 Power Receptacle, 2 Smart USB-A+C Charging, 3 Data Ports	Q, V	EUE2-HLOB-1230	2441.57
						1 Power Receptacle, 3 Smart USB-A+C Charging, 1 Cable Bay	Q, V	EUE2-HLOB-1302	2545.09
						1 Power Receptacle, 3 Smart USB-A+C Charging, 2 Data Ports	Q, V	EUE2-HLOB-1320	2545.09
						2 Power Receptacles, 2 Data Ports, 1 Cable Bay	Q, V	EUE2-HLOB-2022	2234.53
						2 Power Receptacles, 4 Data Ports	Q, V	EUE2-HLOB-2040	2234.53
						2 Power Receptacles, 1 Smart USB-A+C Charging, 1 Data Port, 1 Cable Bay	Q, V	EUE2-HLOB-2112	2338.05
						2 Power Receptacles, 1 Smart USB-A+C Charging, 3 Data Ports	Q, V	EUE2-HLOB-2130	2338.05
						2 Power Receptacles, 2 Smart USB-A+C Charging, 1 Cable Bay	Q, V	EUE2-HLOB-2202	2441.57
						2 Power Receptacles, 2 Smart USB-A+C Charging, 2 Data Ports	Q, V	EUE2-HLOB-2220	2441.57
						2 Power Receptacles, 3 Smart USB-A+C Charging, 1 Data Port	Q, V	EUE2-HLOB-2310	2545.09
						2 Power Receptacles, 4 Smart USB-A+C Charging	Q, V	EUE2-HLOB-2400	2648.61
						3 Power Receptacles, 1 Data Port, 1 Cable Bay	Q, V	EUE2-HLOB-3012	2234.53
						3 Power Receptacles, 3 Data Ports	Q, V	EUE2-HLOB-3030	2234.53
						3 Power Receptacles, 1 Smart USB-A+C Charging, 1 Cable Bay	Q, V	EUE2-HLOB-3102	2338.05
						3 Power Receptacles, 1 Smart USB-A+C Charging, 2 Data Ports	Q, V	EUE2-HLOB-3120	2338.05
						3 Power Receptacles, 2 Smart USB-A+C Charging, 1 Data Port	Q, V	EUE2-HLOB-3210	2441.57
						3 Power Receptacles, 3 Smart USB-A+C Charging	Q, V	EUE2-HLOB-3300	2545.09
						4 Power Receptacles, 1 Cable Bay	Q, V	EUE2-HLOB-4002	2234.53
						4 Power Receptacles, 2 Data Ports	Q, V	EUE2-HLOB-4020	2234.53
						4 Power Receptacles, 1 Smart USB-A+C Charging, 1 Data Port	Q, V	EUE2-HLOB-4110	2338.05
						4 Power Receptacles, 2 Smart USB-A+C Charging	Q, V	EUE2-HLOB-4200	2441.57
						5 Power Receptacles, 1 Data Port	Q, V	EUE2-HLOB-5010	2234.53
						5 Power Receptacles, 1 Smart USB-A+C Charging	Q, V	EUE2-HLOB-5100	2338.05
						6 Power Receptacles	Q, V	EUE2-HLOB-6000	2234.53

Electrical Components

Flip Top Unit — Hardwire — Double-Sided

Width	Bezel Depth	Cord Length	Trim Color	Port Color	Port	Configuration	Flip Top Unit Cutout Code Options	Number	Price
5.31" (135mm)	8" (203mm)	12' (3658mm)	Clear Anodized	White	4	1 Power Receptacle, 1 Data Port, 1 Cable Bay	M, P	EUE2-HLOW-1012	\$1954.54
						1 Power Receptacle, 3 Data Ports	M, P	EUE2-HLOW-1030	1954.54
						1 Power Receptacle, 1 Smart USB-A+C Charging, 1 Cable Bay	M, P	EUE2-HLOW-1102	2058.06
						1 Power Receptacle, 1 Smart USB-A+C Charging, 2 Data Ports	M, P	EUE2-HLOW-1120	2058.06
						1 Power Receptacle, 3 Smart USB-A+C Charging	M, P	EUE2-HLOW-1300	2265.10
						2 Power Receptacles, 1 Cable Bay	M, P	EUE2-HLOW-2002	1954.54
						2 Power Receptacles, 2 Data Ports	M, P	EUE2-HLOW-2020	1954.54
						2 Power Receptacles, 1 Smart USB-A+C Charging, 1 Data Port	M, P	EUE2-HLOW-2110	2058.06
						2 Power Receptacles, 2 Smart USB-A+C Charging	M, P	EUE2-HLOW-2200	2161.58
						3 Power Receptacles, 1 Data Port	M, P	EUE2-HLOW-3010	1954.54
						3 Power Receptacles, 1 Smart USB-A+C Charging	M, P	EUE2-HLOW-3100	2058.06
						4 Power Receptacles	M, P	EUE2-HLOW-4000	1954.54
					6	1 Power Receptacle, 3 Data Ports, 1 Cable Bay	Q, V	EUE2-HLOW-1032	\$1954.54
						1 Power Receptacle, 5 Data Ports	Q, V	EUE2-HLOW-1050	1954.54
						1 Power Receptacle, 1 Smart USB-A+C Charging, 2 Data Ports, 1 Cable Bay	Q, V	EUE2-HLOW-1122	2058.06
						1 Power Receptacle, 1 Smart USB-A+C Charging, 4 Data Ports	Q, V	EUE2-HLOW-1140	2058.06
						1 Power Receptacle, 2 Smart USB-A+C Charging, 1 Data Port, 1 Cable Bay	Q, V	EUE2-HLOW-1212	2161.58
						1 Power Receptacle, 2 Smart USB-A+C Charging, 3 Data Ports	Q, V	EUE2-HLOW-1230	2161.58
						1 Power Receptacle, 3 Smart USB-A+C Charging, 1 Cable Bay	Q, V	EUE2-HLOW-1302	2265.10
						1 Power Receptacle, 3 Smart USB-A+C Charging, 2 Data Ports	Q, V	EUE2-HLOW-1320	2265.10
						2 Power Receptacles, 2 Data Ports, 1 Cable Bay	Q, V	EUE2-HLOW-2022	1954.54
						2 Power Receptacles, 4 Data Ports	Q, V	EUE2-HLOW-2040	1954.54
						2 Power Receptacles, 1 Smart USB-A+C Charging, 1 Data Port, 1 Cable Bay	Q, V	EUE2-HLOW-2112	2058.06
						2 Power Receptacles, 1 Smart USB-A+C Charging, 3 Data Ports	Q, V	EUE2-HLOW-2130	2058.06
						2 Power Receptacles, 2 Smart USB-A+C Charging, 1 Cable Bay	Q, V	EUE2-HLOW-2202	2161.58
						2 Power Receptacles, 2 Smart USB-A+C Charging, 2 Data Ports	Q, V	EUE2-HLOW-2220	2161.58
						2 Power Receptacles, 3 Smart USB-A+C Charging, 1 Data Port	Q, V	EUE2-HLOW-2310	2265.10
						2 Power Receptacles, 4 Smart USB-A+C Charging	Q, V	EUE2-HLOW-2400	2368.62
						3 Power Receptacles, 1 Data Port, 1 Cable Bay	Q, V	EUE2-HLOW-3012	1954.54
						3 Power Receptacles, 3 Data Ports	Q, V	EUE2-HLOW-3030	1954.54
						3 Power Receptacles, 1 Smart USB-A+C Charging, 1 Cable Bay	Q, V	EUE2-HLOW-3102	2058.06
						3 Power Receptacles, 1 Smart USB-A+C Charging, 2 Data Ports	Q, V	EUE2-HLOW-3120	2058.06
						3 Power Receptacles, 2 Smart USB-A+C Charging, 1 Data Port	Q, V	EUE2-HLOW-3210	2161.58
						3 Power Receptacles, 3 Smart USB-A+C Charging	Q, V	EUE2-HLOW-3300	2265.10
						4 Power Receptacles, 1 Cable Bay	Q, V	EUE2-HLOW-4002	1954.54
						4 Power Receptacles, 2 Data Ports	Q, V	EUE2-HLOW-4020	1954.54
						4 Power Receptacles, 1 Smart USB-A+C Charging, 1 Data Port	Q, V	EUE2-HLOW-4110	2058.06
						4 Power Receptacles, 2 Smart USB-A+C Charging	Q, V	EUE2-HLOW-4200	2161.58
						5 Power Receptacles, 1 Data Port	Q, V	EUE2-HLOW-5010	1954.54
						5 Power Receptacles, 1 Smart USB-A+C Charging	Q, V	EUE2-HLOW-5100	2058.06
						6 Power Receptacles	Q, V	EUE2-HLOW-6000	1954.54

This page intentionally blank

Electrical Components

Flush Mounted Power — Corded

3-Port:

- (2) Power
- (1) Smart USB-A+C

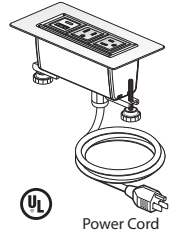

Power Cord

EUB1-PL0B-2100

4-Port:

- (2) Power
- (1) Smart USB-A+C
- (1) Data

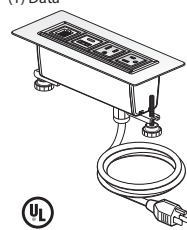

Power Cord

EUB1-PL0B-2110

6-Port:

- (2) Power
- (1) Smart USB-A+C
- (1) Data
- (1) Cable Bay

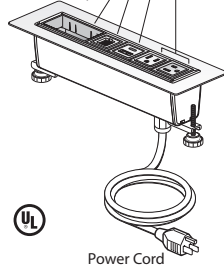

Power Cord

EUB1-PL0B-2112

4-Port:

- (4) Power

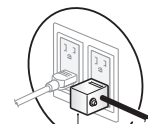
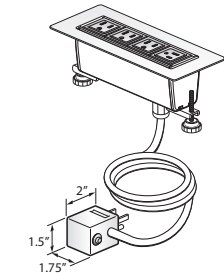

NOTE:

Always Circuit Breaker Plug when more than 3 power outlets specified.

EUB1-PL0B-4000

Features

- Includes power module with 3, 4 or 6 ports that can be configured with simplex outlets (NEMA-5-15R), USB charging port (Smart USB-A+C), data ports or cable bay(s) that can accept up to two pull out data/AV cables and mounting hardware.
- Data port accommodate most varieties of field supplied data/AV jacks.
- Corded power module with 15 amp - 12'(3658mm) long cord with plug (NEMA 5-15P).
- The Smart USB-A+C allows for the 20W to be transferred between the 2 ports. If the USB-A is being used, the full wattage is sent to the USB-A, and the same for the USB-C. If both are being used, the wattage is distributed to each port and the port drawing the most power will receive more watts than the one that is not.
- Attaches to surface with use of included mounting brackets.
- Flush Mount has an overall housing depth of 4"(102mm) and will extend into mounting surface.
- Color option of black painted bezel with black receptacles or white painted bezel with white receptacles.

Specification Tips

- Designed to be used with 1.18"(30mm) and 2"(51mm) thick surfaces with clear space below.
- **Configuration and quantity of power and data ports cannot be modified in the field.**
- **For use with 120 volt 60 hertz power source only.**
- Requires field installation.
- Requires field cut access hole for power cord/conduit routing.
- Specify AV cables separately.
- Cable Bay requires cables less than 0.3"(7.6mm) diameter.
- Application may require approval of local authority having jurisdiction (AHJ); ensure compliance before placing orders and installation.

To Order, Specify:

- 1) Product number.
(No finish specification required.)

Electrical Components

Flush Mounted Power — Corded

Top Width	Top Depth	Cord Length	Trim Color	Port Color	Port	Configuration	Number	Price
Corded								
6.75"(171mm)	3"(76mm)	12'(3658mm)	Black	Black	3	1 Power Receptacle, 1 Cable Bay	EUB1-PL0B-1002	\$1279.66
						1 Power Receptacle, 2 Data Ports	EUB1-PL0B-1020	1279.66
						1 Power Receptacle, 1 Data Port, 1 Smart USB-A+C Charging	EUB1-PL0B-1110	1383.48
						1 Power Receptacle, 2 Smart USB-A+C Charging	EUB1-PL0B-1200	1487.30
						2 Power Receptacles, 1 Data Port	EUB1-PL0B-2010	1279.66
						2 Power Receptacles, 1 Smart USB-A+C Charging	EUB1-PL0B-2100	1383.48
						3 Power Receptacles	EUB1-PL0B-3000	1279.66
8.25"(210mm)	3"(76mm)				4	1 Power Receptacle, 1 Data Port, 1 Cable Bay	EUB1-PL0B-1012	\$1369.62
						1 Power Receptacle, 3 Data Ports	EUB1-PL0B-1030	1369.62
						1 Power Receptacle, 1 Smart USB-A+C Charging, 1 Cable Bay	EUB1-PL0B-1102	1473.44
						1 Power Receptacle, 3 Smart USB-A+C Charging	EUB1-PL0B-1300	1681.08
						2 Power Receptacles, 1 Cable Bay	EUB1-PL0B-2002	1369.62
						2 Power Receptacles, 2 Data Ports	EUB1-PL0B-2020	1369.62
						2 Power Receptacles, 1 Smart USB-A+C Charging, 1 Data Port	EUB1-PL0B-2110	1473.44
						2 Power Receptacles, 2 Smart USB-A+C Charging	EUB1-PL0B-2200	1577.26
						3 Power Receptacles, 1 Data Port	EUB1-PL0B-3010	1369.62
						3 Power Receptacles, 1 Smart USB-A+C Charging	EUB1-PL0B-3100	1473.44
9.75"(248mm)	3"(76mm)				6	1 Power Receptacle, 1 Smart USB-A+C Charging, 2 Cable Bays	EUB1-PL0B-1104	\$1563.46
						1 Power Receptacle, 1 Smart USB-A+C Charging, 2 Data Ports, 1 Cable Bay	EUB1-PL0B-1122	1563.46
						1 Power Receptacle, 1 Smart USB-A+C Charging, 4 Data Ports	EUB1-PL0B-1140	1563.46
						1 Power Receptacle, 2 Smart USB-A+C Charging, 1 Data Port, 1 Cable Bay	EUB1-PL0B-1212	1667.28
						1 Power Receptacle, 2 Smart USB-A+C Charging, 3 Data Ports	EUB1-PL0B-1230	1667.28
						1 Power Receptacle, 3 Smart USB-A+C Charging, 1 Cable Bay	EUB1-PL0B-1302	1771.10
						1 Power Receptacle, 3 Smart USB-A+C Charging, 2 Data Ports	EUB1-PL0B-1320	1771.10
						1 Power Receptacle, 4 Smart USB-A+C Charging, 1 Data Port	EUB1-PL0B-1410	1874.92
						2 Power Receptacles, 2 Cable Bays	EUB1-PL0B-2004	1459.64
						2 Power Receptacles, 2 Data Ports, 1 Cable Bay	EUB1-PL0B-2022	1459.64
						2 Power Receptacles, 4 Data Ports	EUB1-PL0B-2040	1459.64
						2 Power Receptacles, 1 Smart USB-A+C Charging, 1 Data Port, 1 Cable Bay	EUB1-PL0B-2112	1563.46
						2 Power Receptacles, 1 Smart USB-A+C Charging, 3 Data Ports	EUB1-PL0B-2130	1563.46
						2 Power Receptacles, 2 Smart USB-A+C Charging, 1 Cable Bay	EUB1-PL0B-2202	1667.28
						2 Power Receptacles, 2 Smart USB-A+C Charging, 2 Data Ports	EUB1-PL0B-2220	1667.28
						2 Power Receptacles, 3 Smart USB-A+C Charging, 1 Data Port	EUB1-PL0B-2310	1771.10
						2 Power Receptacles, 4 Smart USB-A+C Charging	EUB1-PL0B-2400	1874.92
						3 Power Receptacles, 3 Data Ports	EUB1-PL0B-3030	1459.64
						3 Power Receptacles, 1 Smart USB-A+C Charging, 1 Cable Bay	EUB1-PL0B-3102	1563.46
						3 Power Receptacles, 1 Smart USB-A+C Charging, 2 Data Ports	EUB1-PL0B-3120	1563.46
						3 Power Receptacles, 2 Smart USB-A+C Charging, 1 Data Port	EUB1-PL0B-3210	1667.28
						3 Power Receptacles, 3 Smart USB-A+C Charging	EUB1-PL0B-3300	1771.10
						4 Power Receptacles, 1 Cable Bay	EUB1-PL0B-4002	1459.64
4 Power Receptacles, 2 Data Ports	EUB1-PL0B-4020	1459.64						
4 Power Receptacles, 1 Smart USB-A+C Charging, 1 Data Port	EUB1-PL0B-4110	1563.46						
4 Power Receptacles, 2 Smart USB-A+C Charging	EUB1-PL0B-4200	1667.28						
5 Power Receptacles, 1 Data Port	EUB1-PL0B-5010	1459.64						
5 Power Receptacles, 1 Smart USB-A+C Charging	EUB1-PL0B-5100	1563.46						
						6 Power Receptacles	EUB1-PL0B-6000	1459.64

Electrical Components

Flush Mounted Power — Corded

Top Width	Top Depth	Cord Length	Trim Color	Port Color	Port	Configuration	Number	Price						
6.75"(171mm)	3"(76mm)	12'(3658mm)	White	White	3	1 Power Receptacle, 1 Cable Bay	EUB1-PL0W-1002	\$1099.68						
						1 Power Receptacle, 2 Data Ports	EUB1-PL0W-1020	1099.68						
						1 Power Receptacle, 1 Data Port, 1 Smart USB-A+C Charging	EUB1-PL0W-1110	1203.50						
						1 Power Receptacle, 2 Smart USB-A+C Charging	EUB1-PL0W-1200	1307.32						
						2 Power Receptacles, 1 Data Port	EUB1-PL0W-2010	1099.68						
						2 Power Receptacles, 1 Smart USB-A+C Charging	EUB1-PL0W-2100	1203.50						
8.25"(210mm)	3"(76mm)				4	3 Power Receptacles	EUB1-PL0W-3000	1099.68						
						1 Power Receptacle, 1 Data Port, 1 Cable Bay	EUB1-PL0W-1012	\$1189.64						
						1 Power Receptacle, 3 Data Ports	EUB1-PL0W-1030	1189.64						
						1 Power Receptacle, 1 Smart USB-A+C Charging, 1 Cable Bay	EUB1-PL0W-1102	1293.46						
						1 Power Receptacle, 3 Smart USB-A+C Charging	EUB1-PL0W-1300	1501.10						
						2 Power Receptacles, 1 Cable Bay	EUB1-PL0W-2002	1189.64						
						2 Power Receptacles, 2 Data Ports	EUB1-PL0W-2020	1189.64						
						2 Power Receptacles, 1 Smart USB-A+C Charging, 1 Data Port	EUB1-PL0W-2110	1293.46						
						2 Power Receptacles, 2 Smart USB-A+C Charging	EUB1-PL0W-2200	1397.28						
						3 Power Receptacles, 1 Data Port	EUB1-PL0W-3010	1189.64						
						3 Power Receptacles, 1 Smart USB-A+C Charging	EUB1-PL0W-3100	1293.46						
						4 Power Receptacles	EUB1-PL0W-4000	1189.64						
						9.75"(248mm)	3"(76mm)				6	1 Power Receptacle, 1 Smart USB-A+C Charging, 2 Cable Bays	EUB1-PL0W-1104	\$1383.48
												1 Power Receptacle, 1 Smart USB-A+C Charging, 2 Data Ports, 1 Cable Bay	EUB1-PL0W-1122	1383.48
1 Power Receptacle, 1 Smart USB-A+C Charging, 4 Data Ports	EUB1-PL0W-1140	1383.48												
1 Power Receptacle, 2 Smart USB-A+C Charging, 1 Data Port, 1 Cable Bay	EUB1-PL0W-1212	1487.30												
1 Power Receptacle, 2 Smart USB-A+C Charging, 3 Data Ports	EUB1-PL0W-1230	1487.30												
1 Power Receptacle, 3 Smart USB-A+C Charging, 1 Cable Bay	EUB1-PL0W-1302	1591.12												
1 Power Receptacle, 3 Smart USB-A+C Charging, 2 Data Ports	EUB1-PL0W-1320	1591.12												
1 Power Receptacle, 4 Smart USB-A+C Charging, 1 Data Port	EUB1-PL0W-1410	1694.94												
2 Power Receptacles, 2 Cable Bays	EUB1-PL0W-2004	1279.66												
2 Power Receptacles, 2 Data Ports, 1 Cable Bay	EUB1-PL0W-2022	1279.66												
2 Power Receptacles, 4 Data Ports	EUB1-PL0W-2040	1279.66												
2 Power Receptacles, 1 Smart USB-A+C Charging, 1 Data Port, 1 Cable Bay	EUB1-PL0W-2112	1383.48												
2 Power Receptacles, 1 Smart USB-A+C Charging, 3 Data Ports	EUB1-PL0W-2130	1383.48												
2 Power Receptacles, 2 Smart USB-A+C Charging, 1 Cable Bay	EUB1-PL0W-2202	1487.30												
2 Power Receptacles, 2 Smart USB-A+C Charging, 2 Data Ports	EUB1-PL0W-2220	1487.30												
2 Power Receptacles, 3 Smart USB-A+C Charging, 1 Data Port	EUB1-PL0W-2310	1591.12												
2 Power Receptacles, 4 Smart USB-A+C Charging	EUB1-PL0W-2400	1694.94												
3 Power Receptacles, 3 Data Ports	EUB1-PL0W-3030	1279.66												
3 Power Receptacles, 1 Smart USB-A+C Charging, 1 Cable Bay	EUB1-PL0W-3102	1383.48												
3 Power Receptacles, 1 Smart USB-A+C Charging, 2 Data Ports	EUB1-PL0W-3120	1383.48												
3 Power Receptacles, 2 Smart USB-A+C Charging, 1 Data Port	EUB1-PL0W-3210	1487.30												
3 Power Receptacles, 3 Smart USB-A+C Charging	EUB1-PL0W-3300	1591.12												
4 Power Receptacles, 1 Cable Bay	EUB1-PL0W-4002	1279.66												
4 Power Receptacles, 2 Data Ports	EUB1-PL0W-4020	1279.66												
4 Power Receptacles, 1 Smart USB-A+C Charging, 1 Data Port	EUB1-PL0W-4110	1383.48												
4 Power Receptacles, 2 Smart USB-A+C Charging	EUB1-PL0W-4200	1487.30												
5 Power Receptacles, 1 Data Port	EUB1-PL0W-5010	1279.66												
5 Power Receptacles, 1 Smart USB-A+C Charging	EUB1-PL0W-5100	1383.48												
6 Power Receptacles	EUB1-PL0W-6000	1279.66												

This page intentionally blank

Electrical Components

Flush Mounted Power — Hardwire

3-Port:

- (2) Power
- (1) Smart USB-A+C

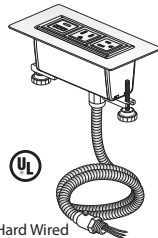

Hard Wired
EUB1-HLOB-2100

4-Port:

- (2) Power
- (1) Smart USB-A+C
- (1) Data

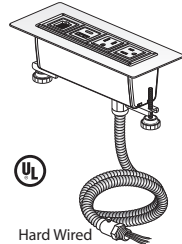

Hard Wired
EUB1-HLOB-2110

6-Port:

- (2) Power
- (1) Smart USB-A+C
- (1) Data
- (1) Cable Bay

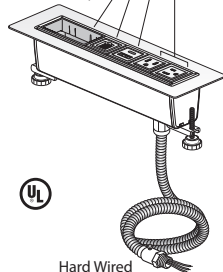

Hard Wired
EUB1-HLOB-2112

Features

- Includes power module with 3, 4 or 6 ports that can be configured with simplex outlets (NEMA-5-15R), USB charging port (Smart USB-A+C), data ports or cable bay(s) that can accept up to two pull out data/AV cables and mounting hardware.
- Data port accommodate most varieties of field supplied data/AV jacks.
- Hardwired power module with 12'(3658mm) long flexible metal conduit feed, 0.5"(13mm) conduit fitting and wires for hardwire connection.
- The Smart USB-A+C allows for the 20W to be transferred between the 2 ports. If the USB-A is being used, the full wattage is sent to the USB-A, and the same for the USB-C. If both are being used, the wattage is distributed to each port and the port drawing the most power will receive more watts than the one that is not.
- Attaches to surface with use of included mounting brackets.
- Flush Mount has an overall housing depth of 4"(102mm) and will extend into mounting surface.
- Color option of black painted bezel with black receptacles or white painted bezel with white receptacles.

Specification Tips

- Designed to be used with 1.18"(30mm) and 2"(51mm) thick surfaces with clear space below.
- **Configuration and quantity of power and data ports cannot be modified in the field.**
- **For use with 120 volt 60 hertz power source only.**
- Requires field installation.
- Requires field cut access hole for power cord/conduit routing.
- Specify AV cables separately.
- Cable Bay requires cables less than 0.3"(7.6mm) diameter.
- Application may require approval of local authority having jurisdiction (AHJ); ensure compliance before placing orders and installation.

To Order, Specify:

- 1) Product number.
(No finish specification required.)

Electrical Components

Flush Mounted Power — Hardwire

Top Width	Top Depth	Conduit Length	Trim Color	Port Color	Port	Power	USB Charging	Data Port	Cable Bay	Description	Number	Price
Corded												
6.75" (171mm)	3" (76mm)	12' (3658mm)	Black	Black	3	1	0	0	2	1 Power Receptacle, 1 Cable Bay	EUB1-HLOB-1002	\$1399.84
						1	0	2	0	1 Power Receptacle, 2 Data Ports	EUB1-HLOB-1020	1399.84
						1	1	1	0	1 Power Receptacle, 1 Data Port, 1 Smart USB-A+C Charging	EUB1-HLOB-1110	1503.66
						1	2	0	0	1 Power Receptacle, 2 Smart USB-A+C Charging	EUB1-HLOB-1200	1607.48
						2	0	1	0	2 Power Receptacles, 1 Data Port	EUB1-HLOB-2010	1399.84
						2	1	0	0	2 Power Receptacles, 1 Smart USB-A+C Charging	EUB1-HLOB-2100	1503.66
						3	0	0	0	3 Power Receptacles	EUB1-HLOB-3000	1399.84
8.25" (210mm)	3" (76mm)				4	1	0	1	2	1 Power Receptacle, 1 Data Port, 1 Cable Bay	EUB1-HLOB-1012	\$1489.80
						1	0	3	0	1 Power Receptacle, 3 Data Ports	EUB1-HLOB-1030	1489.80
						1	1	0	2	1 Power Receptacle, 1 Smart USB-A+C Charging, 1 Cable Bay	EUB1-HLOB-1102	1593.62
						1	3	0	0	1 Power Receptacle, 3 Smart USB-A+C Charging	EUB1-HLOB-1300	1801.26
						2	0	0	2	2 Power Receptacles, 1 Cable Bay	EUB1-HLOB-2002	1489.80
						2	0	2	0	2 Power Receptacles, 2 Data Ports	EUB1-HLOB-2020	1489.80
						2	1	1	0	2 Power Receptacles, 1 Smart USB-A+C Charging, 1 Data Port	EUB1-HLOB-2110	1593.62
						2	2	0	0	2 Power Receptacles, 2 Smart USB-A+C Charging	EUB1-HLOB-2200	1697.44
						3	0	1	0	3 Power Receptacles, 1 Data Port	EUB1-HLOB-3010	1489.80
						3	1	0	0	3 Power Receptacles, 1 Smart USB-A+C Charging	EUB1-HLOB-3100	1593.62
						4	0	0	0	4 Power Receptacles	EUB1-HLOB-4000	1489.80
9.75" (248mm)	3" (76mm)				6	1	1	0	4	1 Power Receptacle, 1 Smart USB-A+C Charging, 2 Cable Bays	EUB1-HLOB-1104	\$1683.64
						1	1	2	2	1 Power Receptacle, 1 Smart USB-A+C Charging, 2 Data Ports, 1 Cable Bay	EUB1-HLOB-1122	1683.64
						1	1	4	0	1 Power Receptacle, 1 Smart USB-A+C Charging, 4 Data Ports	EUB1-HLOB-1140	1683.64
						1	2	1	2	1 Power Receptacle, 2 Smart USB-A+C Charging, 1 Data Port, 1 Cable Bay	EUB1-HLOB-1212	1787.46
						1	2	3	0	1 Power Receptacle, 2 Smart USB-A+C Charging, 3 Data Ports	EUB1-HLOB-1230	1787.46
						1	3	0	2	1 Power Receptacle, 3 Smart USB-A+C Charging, 1 Cable Bay	EUB1-HLOB-1302	1891.28
						1	3	2	0	1 Power Receptacle, 3 Smart USB-A+C Charging, 2 Data Ports	EUB1-HLOB-1320	1891.28
						1	4	1	0	1 Power Receptacle, 4 Smart USB-A+C Charging, 1 Data Port	EUB1-HLOB-1410	1995.10
						2	0	0	4	2 Power Receptacles, 2 Cable Bays	EUB1-HLOB-2004	1579.82
						2	0	2	2	2 Power Receptacles, 2 Data Ports, 1 Cable Bay	EUB1-HLOB-2022	1579.82
						2	0	4	0	2 Power Receptacles, 4 Data Ports	EUB1-HLOB-2040	1579.82
						2	1	1	2	2 Power Receptacles, 1 Smart USB-A+C Charging, 1 Data Port, 1 Cable Bay	EUB1-HLOB-2112	1683.64
						2	1	3	0	2 Power Receptacles, 1 Smart USB-A+C Charging, 3 Data Ports	EUB1-HLOB-2130	1683.64
						2	2	0	2	2 Power Receptacles, 2 Smart USB-A+C Charging, 1 Cable Bay	EUB1-HLOB-2202	1787.46
						2	2	2	0	2 Power Receptacles, 2 Smart USB-A+C Charging, 2 Data Ports	EUB1-HLOB-2220	1787.46
						2	3	1	0	2 Power Receptacles, 3 Smart USB-A+C Charging, 1 Data Port	EUB1-HLOB-2310	1891.28
						2	4	0	0	2 Power Receptacles, 4 Smart USB-A+C Charging	EUB1-HLOB-2400	1995.10
						3	0	3	0	3 Power Receptacles, 3 Data Ports	EUB1-HLOB-3030	1579.82
						3	1	0	2	3 Power Receptacles, 1 Smart USB-A+C Charging, 1 Cable Bay	EUB1-HLOB-3102	1683.64
						3	1	2	0	3 Power Receptacles, 1 Smart USB-A+C Charging, 2 Data Ports	EUB1-HLOB-3120	1683.64
						3	2	1	0	3 Power Receptacles, 2 Smart USB-A+C Charging, 1 Data Port	EUB1-HLOB-3210	1787.46
						3	3	0	0	3 Power Receptacles, 3 Smart USB-A+C Charging	EUB1-HLOB-3300	1891.28
						4	0	0	2	4 Power Receptacles, 1 Cable Bay	EUB1-HLOB-4002	1579.82
						4	0	2	0	4 Power Receptacles, 2 Data Ports	EUB1-HLOB-4020	1579.82
						4	1	1	0	4 Power Receptacles, 1 Smart USB-A+C Charging, 1 Data Port	EUB1-HLOB-4110	1683.64
						4	2	0	0	4 Power Receptacles, 2 Smart USB-A+C Charging	EUB1-HLOB-4200	1787.46
						5	0	1	0	5 Power Receptacles, 1 Data Port	EUB1-HLOB-5010	1579.82
						5	1	0	0	5 Power Receptacles, 1 Smart USB-A+C Charging	EUB1-HLOB-5100	1683.64
						6	0	0	0	6 Power Receptacles	EUB1-HLOB-6000	1579.82

Electrical Components

Flush Mounted Power — Hardwire

Top Width	Top Depth	Conduit Length	Trim Color	Port Color	Port	Power	USB Charging	Data Port	Cable Bay	Description	Number	Price
6.75" (171mm)	3" (76mm)	12' (3658mm)	White	White	3	1	0	0	2	1 Power Receptacle, 1 Cable Bay	EUB1-HLOW-1002	\$1219.86
						1	0	2	0	1 Power Receptacle, 2 Data Ports	EUB1-HLOW-1020	1219.86
						1	1	1	0	1 Power Receptacle, 1 Data Port, 1 Smart USB-A+C Charging	EUB1-HLOW-1110	1323.68
						1	2	0	0	1 Power Receptacle, 2 Smart USB-A+C Charging	EUB1-HLOW-1200	1427.50
						2	0	1	0	2 Power Receptacles, 1 Data Port	EUB1-HLOW-2010	1219.86
						2	1	0	0	2 Power Receptacles, 1 Smart USB-A+C Charging	EUB1-HLOW-2100	1323.68
						3	0	0	0	3 Power Receptacles	EUB1-HLOW-3000	1219.86
8.25" (210mm)	3" (76mm)				4	1	0	1	2	1 Power Receptacle, 1 Data Port, 1 Cable Bay	EUB1-HLOW-1012	\$1309.82
						1	0	3	0	1 Power Receptacle, 3 Data Ports	EUB1-HLOW-1030	1309.82
						1	1	0	2	1 Power Receptacle, 1 Smart USB-A+C Charging, 1 Cable Bay	EUB1-HLOW-1102	1413.64
						1	3	0	0	1 Power Receptacle, 3 Smart USB-A+C Charging	EUB1-HLOW-1300	1621.28
						2	0	0	2	2 Power Receptacles, 1 Cable Bay	EUB1-HLOW-2002	1309.82
						2	0	2	0	2 Power Receptacles, 2 Data Ports	EUB1-HLOW-2020	1309.82
						2	1	1	0	2 Power Receptacles, 1 Smart USB-A+C Charging, 1 Data Port	EUB1-HLOW-2110	1413.64
						2	2	0	0	2 Power Receptacles, 2 Smart USB-A+C Charging	EUB1-HLOW-2200	1517.46
						3	0	1	0	3 Power Receptacles, 1 Data Port	EUB1-HLOW-3010	1309.82
						3	1	0	0	3 Power Receptacles, 1 Smart USB-A+C Charging	EUB1-HLOW-3100	1413.64
						4	0	0	0	4 Power Receptacles	EUB1-HLOW-4000	1309.82
9.75" (248mm)	3" (76mm)				6	1	1	0	4	1 Power Receptacle, 1 Smart USB-A+C Charging, 2 Cable Bays	EUB1-HLOW-1104	\$1503.66
						1	1	2	2	1 Power Receptacle, 1 Smart USB-A+C Charging, 2 Data Ports, 1 Cable Bay	EUB1-HLOW-1122	1503.66
						1	1	4	0	1 Power Receptacle, 1 Smart USB-A+C Charging, 4 Data Ports	EUB1-HLOW-1140	1503.66
						1	2	1	2	1 Power Receptacle, 2 Smart USB-A+C Charging, 1 Data Port, 1 Cable Bay	EUB1-HLOW-1212	1607.48
						1	2	3	0	1 Power Receptacle, 2 Smart USB-A+C Charging, 3 Data Ports	EUB1-HLOW-1230	1607.48
						1	3	0	2	1 Power Receptacle, 3 Smart USB-A+C Charging, 1 Cable Bay	EUB1-HLOW-1302	1711.30
						1	3	2	0	1 Power Receptacle, 3 Smart USB-A+C Charging, 2 Data Ports	EUB1-HLOW-1320	1711.30
						1	4	1	0	1 Power Receptacle, 4 Smart USB-A+C Charging, 1 Data Port	EUB1-HLOW-1410	1815.12
						2	0	0	4	2 Power Receptacles, 2 Cable Bays	EUB1-HLOW-2004	1399.84
						2	0	2	2	2 Power Receptacles, 2 Data Ports, 1 Cable Bay	EUB1-HLOW-2022	1399.84
						2	0	4	0	2 Power Receptacles, 4 Data Ports	EUB1-HLOW-2040	1399.84
						2	1	1	2	2 Power Receptacles, 1 Smart USB-A+C Charging, 1 Data Port, 1 Cable Bay	EUB1-HLOW-2112	1503.66
						2	1	3	0	2 Power Receptacles, 1 Smart USB-A+C Charging, 3 Data Ports	EUB1-HLOW-2130	1503.66
						2	2	0	2	2 Power Receptacles, 2 Smart USB-A+C Charging, 1 Cable Bay	EUB1-HLOW-2202	1607.48
						2	2	2	0	2 Power Receptacles, 2 Smart USB-A+C Charging, 2 Data Ports	EUB1-HLOW-2220	1607.48
						2	3	1	0	2 Power Receptacles, 3 Smart USB-A+C Charging, 1 Data Port	EUB1-HLOW-2310	1711.30
						2	4	0	0	2 Power Receptacles, 4 Smart USB-A+C Charging	EUB1-HLOW-2400	1815.12
						3	0	3	0	3 Power Receptacles, 3 Data Ports	EUB1-HLOW-3030	1399.84
						3	1	0	2	3 Power Receptacles, 1 Smart USB-A+C Charging, 1 Cable Bay	EUB1-HLOW-3102	1503.66
						3	1	2	0	3 Power Receptacles, 1 Smart USB-A+C Charging, 2 Data Ports	EUB1-HLOW-3120	1503.66
						3	2	1	0	3 Power Receptacles, 2 Smart USB-A+C Charging, 1 Data Port	EUB1-HLOW-3210	1607.48
						3	3	0	0	3 Power Receptacles, 3 Smart USB-A+C Charging	EUB1-HLOW-3300	1711.30
						4	0	0	2	4 Power Receptacles, 1 Cable Bay	EUB1-HLOW-4002	1399.84
						4	0	2	0	4 Power Receptacles, 2 Data Ports	EUB1-HLOW-4020	1399.84
						4	1	1	0	4 Power Receptacles, 1 Smart USB-A+C Charging, 1 Data Port	EUB1-HLOW-4110	1503.66
						4	2	0	0	4 Power Receptacles, 2 Smart USB-A+C Charging	EUB1-HLOW-4200	1607.48
						5	0	1	0	5 Power Receptacles, 1 Data Port	EUB1-HLOW-5010	1399.84
						5	1	0	0	5 Power Receptacles, 1 Smart USB-A+C Charging	EUB1-HLOW-5100	1503.66
						6	0	0	0	6 Power Receptacles	EUB1-HLOW-6000	1399.84

This page intentionally blank

Electrical Components

Flush Mounted Power — Spiral Cord for Height Adjustable

3-Port:

- (2) Power
- (1) Smart USB-A+C

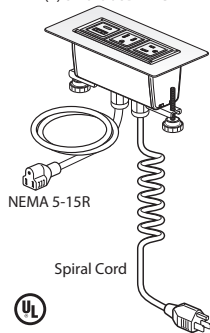

EUB1-SF0B-2100

4-Port:

- (2) Power
- (1) Smart USB-A+C
- (1) Data

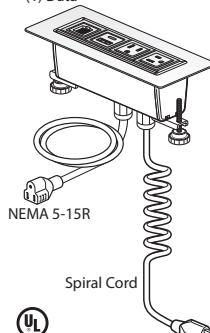

EUB1-SF0B-2110

6-Port:

- (2) Power
- (1) Smart USB-A+C
- (1) Data
- (1) Cable Bay

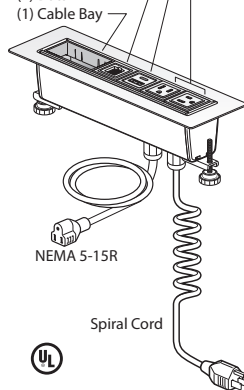

EUB1-SF0B-2112

Features

- Includes power module with 3, 4 or 6 ports that can be configured with simplex outlets (NEMA-5-15R), USB charging port (Smart USB-A+C), data ports or cable bay(s) that can accept up to two pull out data/AV cables and mounting hardware.
- Data port accommodate most varieties of field supplied data/AV jacks.
- Spiral Cord includes 15 amp plug (NEMA 5-15P) and expands to 12'(3658mm) when stretched.
- Auxiliary 24"(610mm) power cord with NEMA 5-15R used to provide power to table motor controller.
- The Smart USB-A+C allows for the 20W to be transferred between the 2 ports. If the USB-A is being used, the full wattage is sent to the USB-A, and the same for the USB-C. If both are being used, the wattage is distributed to each port and the port drawing the most power will receive more watts than the one that is not.
- Attaches to surface with use of included mounting brackets.
- Flush Mount has an overall housing depth of 4"(102mm) and will extend into mounting surface.
- Color option of black painted bezel with black receptacles or white painted bezel with white receptacles.

To Order, Specify:

- 1) Product number.
(No finish specification required.)

Specification Tips

- **Configuration and quantity of power and data ports cannot be modified in the field.**
- **For use with 120 volt 60 hertz power source only.**
- **For use with Height Adjustable Tables or Benching.**
- Not for use with cable chain.
- Requires field installation.
- Requires field cut access hole for power cord/conduit routing.
- Specify AV cables separately.
- Cable Bay requires cables less than 0.3"(7.6mm) diameter.
- Application may require approval of local authority having jurisdiction (AHJ); ensure compliance before placing orders and installation.

4-Port:

- (4) Power

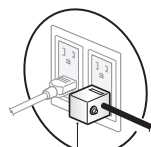
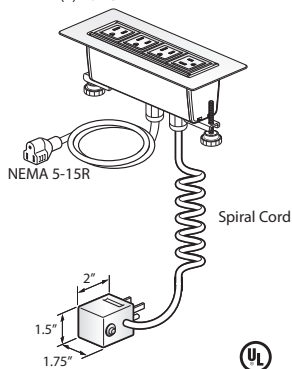

NOTE:
Always Circuit Breaker Plug when more than 3 power outlets specified.

EUB1-SF0B-4000

Electrical Components

Flush Mounted Power — Spiral Cord for Height Adjustable

Top Width	Top Depth	Cord Length	Trim Color	Port Color	Port	Configuration	Number	Price
Corded								
6.75"(171mm)	3"(76mm)	10'(3048mm)	Black	Black	3	2 Power Receptacles, 1 Data Port	EUB1-SF0B-2010	\$1582.02
						2 Power Receptacles, 1 Smart USB-A+C Charging	EUB1-SF0B-2100	1685.84
						3 Power Receptacles	EUB1-SF0B-3000	1582.02
8.25"(210mm)	3"(76mm)				4	2 Power Receptacles, 1 Cable Bay	EUB1-SF0B-2002	1671.98
						2 Power Receptacles, 2 Data Ports	EUB1-SF0B-2020	1671.98
						2 Power Receptacles, 1 Smart USB-A+C Charging, 1 Data Port	EUB1-SF0B-2110	1775.80
						2 Power Receptacles, 2 Smart USB-A+C Charging	EUB1-SF0B-2200	1879.62
						3 Power Receptacles, 1 Data Port	EUB1-SF0B-3010	1671.98
						3 Power Receptacles, 1 Smart USB-A+C Charging	EUB1-SF0B-3100	1775.80
						4 Power Receptacles	EUB1-SF0B-4000	1671.98
9.75"(248mm)	3"(76mm)				6	2 Power Receptacles, 2 Cable Bays	EUB1-SF0B-2004	\$1762.00
						2 Power Receptacles, 2 Data Ports, 1 Cable Bay	EUB1-SF0B-2022	1762.00
						2 Power Receptacles, 4 Data Ports	EUB1-SF0B-2040	1762.00
						2 Power Receptacles, 1 Smart USB-A+C Charging, 1 Data Port, 1 Cable Bay	EUB1-SF0B-2112	1865.82
						2 Power Receptacles, 1 Smart USB-A+C Charging, 3 Data Ports	EUB1-SF0B-2130	1865.82
						2 Power Receptacles, 2 Smart USB-A+C Charging, 1 Cable Bay	EUB1-SF0B-2202	1969.64
						2 Power Receptacles, 2 Smart USB-A+C Charging, 2 Data Ports	EUB1-SF0B-2220	1969.64
						2 Power Receptacles, 3 Smart USB-A+C Charging, 1 Data Port	EUB1-SF0B-2310	2073.46
						2 Power Receptacles, 4 Smart USB-A+C Charging	EUB1-SF0B-2400	2177.28
						3 Power Receptacles, 1 Smart USB-A+C Charging, 1 Cable Bay	EUB1-SF0B-3012	1762.00
						3 Power Receptacles, 3 Data Ports	EUB1-SF0B-3030	1762.00
						3 Power Receptacles, 1 Smart USB-A+C Charging, 1 Cable Bay	EUB1-SF0B-3102	1865.82
						3 Power Receptacles, 1 Smart USB-A+C Charging, 2 Data Ports	EUB1-SF0B-3120	1865.82
						3 Power Receptacles, 2 Smart USB-A+C Charging, 1 Data Port	EUB1-SF0B-3210	1969.64
						3 Power Receptacles, 3 Smart USB-A+C Charging	EUB1-SF0B-3300	2073.46
						4 Power Receptacles, 1 Cable Bay	EUB1-SF0B-4002	1762.00
						4 Power Receptacles, 2 Data Ports	EUB1-SF0B-4020	1762.00
4 Power Receptacles, 1 Smart USB-A+C Charging, 1 Data Port	EUB1-SF0B-4110	1865.82						
4 Power Receptacles, 2 Smart USB-A+C Charging	EUB1-SF0B-4200	1969.64						
5 Power Receptacles, 1 Data Port	EUB1-SF0B-5010	1762.00						
5 Power Receptacles, 1 Smart USB-A+C Charging	EUB1-SF0B-5100	1865.82						
6 Power Receptacles	EUB1-SF0B-6000	1762.00						

Electrical Components

Flush Mounted Power — Spiral Cord for Height Adjustable

Top Width	Top Depth	Cord Length	Trim Color	Port Color	Port	Configuration	Number	Price
6.75"(171mm)	3"(76mm)	10'(3048mm)	White	White	3	2 Power Receptacles, 1 Data Port	EUB1-SF0W-2010	\$1402.04
						2 Power Receptacles, 1 Smart USB-A+C Charging	EUB1-SF0W-2100	1505.86
						3 Power Receptacles	EUB1-SF0W-3000	1402.04
8.25"(210mm)	3"(76mm)				4	2 Power Receptacles, 1 Cable Bay	EUB1-SF0W-2002	\$1492.00
						2 Power Receptacles, 2 Data Ports	EUB1-SF0W-2020	1492.00
						2 Power Receptacles, 1 Smart USB-A+C Charging, 1 Data Port	EUB1-SF0W-2110	1595.82
						2 Power Receptacles, 2 Smart USB-A+C Charging	EUB1-SF0W-2200	1699.64
						3 Power Receptacles, 1 Data Port	EUB1-SF0W-3010	1492.00
						3 Power Receptacles, 1 Smart USB-A+C Charging	EUB1-SF0W-3100	1595.82
						4 Power Receptacles	EUB1-SF0W-4000	1492.00
9.75"(248mm)	3"(76mm)				6	2 Power Receptacles, 2 Cable Bays	EUB1-SF0W-2004	\$1582.02
						2 Power Receptacles, 2 Data Ports, 1 Cable Bay	EUB1-SF0W-2022	1582.02
						2 Power Receptacles, 4 Data Ports	EUB1-SF0W-2040	1582.02
						2 Power Receptacles, 1 Smart USB-A+C Charging, 1 Data Port, 1 Cable Bay	EUB1-SF0W-2112	1685.84
						2 Power Receptacles, 1 Smart USB-A+C Charging, 3 Data Ports	EUB1-SF0W-2130	1685.84
						2 Power Receptacles, 2 Smart USB-A+C Charging, 1 Cable Bay	EUB1-SF0W-2202	1789.66
						2 Power Receptacles, 2 Smart USB-A+C Charging, 2 Data Ports	EUB1-SF0W-2220	1789.66
						2 Power Receptacles, 3 Smart USB-A+C Charging, 1 Data Port	EUB1-SF0W-2310	1893.48
						2 Power Receptacles, 4 Smart USB-A+C Charging	EUB1-SF0W-2400	1997.30
						3 Power Receptacles, 1 Smart USB-A+C Charging, 1 Cable Bay	EUB1-SF0W-3012	1582.02
						3 Power Receptacles, 3 Data Ports	EUB1-SF0W-3030	1582.02
						3 Power Receptacles, 1 Smart USB-A+C Charging, 1 Cable Bay	EUB1-SF0W-3102	1685.84
						3 Power Receptacles, 1 Smart USB-A+C Charging, 2 Data Ports	EUB1-SF0W-3120	1685.84
						3 Power Receptacles, 2 Smart USB-A+C Charging, 1 Data Port	EUB1-SF0W-3210	1789.66
						3 Power Receptacles, 3 Smart USB-A+C Charging	EUB1-SF0W-3300	1893.48
						4 Power Receptacles, 1 Cable Bay	EUB1-SF0W-4002	1582.02
4 Power Receptacles, 2 Data Ports	EUB1-SF0W-4020	1582.02						
4 Power Receptacles, 1 Smart USB-A+C Charging, 1 Data Port	EUB1-SF0W-4110	1685.84						
4 Power Receptacles, 2 Smart USB-A+C Charging	EUB1-SF0W-4200	1789.66						
5 Power Receptacles, 1 Data Port	EUB1-SF0W-5010	1582.02						
5 Power Receptacles, 1 Smart USB-A+C Charging	EUB1-SF0W-5100	1685.84						
6 Power Receptacles	EUB1-SF0W-6000	1582.02						

This page intentionally blank

Electrical Components

Flush Mounted Power — Cord for Height Adjustable

3-Port:

- (2) Power
- (1) Smart USB-A+C

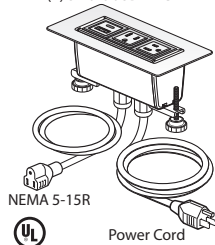

EUB1-SL0B-2100

4-Port:

- (2) Power
- (1) Smart USB-A+C
- (1) Data

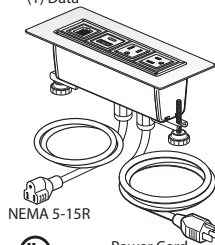

EUB1-SL0B-2110

6-Port:

- (2) Power
- (1) Smart USB-A+C
- (1) Data
- (1) Cable Bay

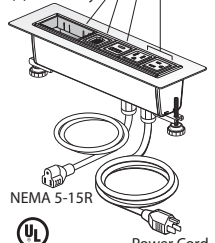

EUB1-SL0B-2112

4-Port:

- (4) Power

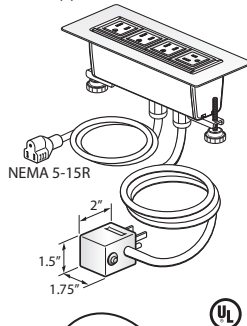

NOTE:
Always Circuit Breaker Plug
when more than 3
power outlets specified.

EUB1-SL0B-4000

Features

- Includes power module with 3, 4 or 6 ports that can be configured with simplex outlets (NEMA-5-15R), USB charging port (Smart USB-A+C), data ports or cable bay(s) that can accept up to two pull out data/AV cables and mounting hardware.
- Data port accommodate most varieties of field supplied data/AV jacks.
- Corded power module with 15 amp - 12'(3658mm) long cord with plug (NEMA 5-15P).
- Auxiliary 24"(610mm) power cord with NEMA 5-15R used to provide power to table motor controller.
- The Smart USB-A+C allows for the 20W to be transferred between the 2 ports. If the USB-A is being used, the full wattage is sent to the USB-A, and the same for the USB-C. If both are being used, the wattage is distributed to each port and the port drawing the most power will receive more watts than the one that is not.
- Attaches to surface with use of included mounting brackets.
- Flush Mount has an overall housing depth of 4"(102mm) and will extend into mounting surface.
- Color option of black painted bezel with black receptacles or white painted bezel with white receptacles.

Specification Tips

- **Configuration and quantity of power and data ports cannot be modified in the field.**
- **For use with 120 volt 60 hertz power source only.**
- **For use with Height Adjustable Tables or Benching.**
- Designed to be used with cable chain.
- Requires field installation.
- Requires field cut access hole for power cord/conduit routing.
- Specify AV cables separately.
- Cable Bay requires cables less than 0.3"(7.6mm) diameter.
- Application may require approval of local authority having jurisdiction (AHJ); ensure compliance before placing orders and installation.

To Order, Specify:

- 1) Product number.
(No finish specification required.)

Electrical Components

Flush Mounted Power — Cord for Height Adjustable

Top Width	Top Depth	Cord Length	Trim Color	Port Color	Port	Configuration	Number	Price
Corded								
6.75"(171mm)	3"(76mm)	12'(3658mm)	Black	Black	3	2 Power Receptacles, 1 Data Port	EUB1-SLOB-2010	\$1666.62
						2 Power Receptacles, 1 Smart USB-A+C Charging	EUB1-SLOB-2100	1770.44
						3 Power Receptacles	EUB1-SLOB-3000	1666.62
8.25"(210mm)	3"(76mm)				4	2 Power Receptacles, 1 Cable Bay	EUB1-SLOB-2002	\$1756.58
						2 Power Receptacles, 2 Data Ports	EUB1-SLOB-2020	1756.58
						2 Power Receptacles, 1 Smart USB-A+C Charging, 1 Data Port	EUB1-SLOB-2110	1860.40
						2 Power Receptacles, 2 Smart USB-A+C Charging	EUB1-SLOB-2200	1964.22
						3 Power Receptacles, 1 Data Port	EUB1-SLOB-3010	1756.58
						3 Power Receptacles, 1 Smart USB-A+C Charging	EUB1-SLOB-3100	1860.40
						4 Power Receptacles	EUB1-SLOB-4000	1756.58
9.75"(248mm)	3"(76mm)				6	2 Power Receptacles, 2 Cable Bays	EUB1-SLOB-2004	\$1846.60
						2 Power Receptacles, 2 Data Ports, 1 Cable Bay	EUB1-SLOB-2022	1846.60
						2 Power Receptacles, 4 Data Ports	EUB1-SLOB-2040	1846.60
						2 Power Receptacles, 1 Smart USB-A+C Charging, 1 Data Port, 1 Cable Bay	EUB1-SLOB-2112	1950.42
						2 Power Receptacles, 1 Smart USB-A+C Charging, 3 Data Ports	EUB1-SLOB-2130	1950.42
						2 Power Receptacles, 2 Smart USB-A+C Charging, 1 Cable Bay	EUB1-SLOB-2202	2054.24
						2 Power Receptacles, 2 Smart USB-A+C Charging, 2 Data Ports	EUB1-SLOB-2220	2054.24
						2 Power Receptacles, 3 Smart USB-A+C Charging, 1 Data Port	EUB1-SLOB-2310	2158.06
						2 Power Receptacles, 4 Smart USB-A+C Charging	EUB1-SLOB-2400	2261.88
						3 Power Receptacles, 1 Smart USB-A+C Charging, 1 Cable Bay	EUB1-SLOB-3012	1846.60
						3 Power Receptacles, 3 Data Ports	EUB1-SLOB-3030	1846.60
						3 Power Receptacles, 1 Smart USB-A+C Charging, 1 Cable Bay	EUB1-SLOB-3102	1950.42
						3 Power Receptacles, 1 Smart USB-A+C Charging, 2 Data Ports	EUB1-SLOB-3120	1950.42
						3 Power Receptacles, 2 Smart USB-A+C Charging, 1 Data Port	EUB1-SLOB-3210	2054.24
						3 Power Receptacles, 3 Smart USB-A+C Charging	EUB1-SLOB-3300	2158.06
						4 Power Receptacles, 1 Cable Bay	EUB1-SLOB-4002	1846.60
						4 Power Receptacles, 2 Data Ports	EUB1-SLOB-4020	1846.60
4 Power Receptacles, 1 Smart USB-A+C Charging, 1 Data Port	EUB1-SLOB-4110	1950.42						
4 Power Receptacles, 2 Smart USB-A+C Charging	EUB1-SLOB-4200	2054.24						
5 Power Receptacles, 1 Data Port	EUB1-SLOB-5010	1846.60						
5 Power Receptacles, 1 Smart USB-A+C Charging	EUB1-SLOB-5100	1950.42						
6 Power Receptacles	EUB1-SLOB-6000	1846.60						

Electrical Components

Flush Mounted Power — Cord for Height Adjustable

Top Width	Top Depth	Cord Length	Trim Color	Port Color	Port	Configuration	Number	Price
6.75"(171mm)	3"(76mm)	12'(3658mm)	White	White	3	2 Power Receptacles, 1 Data Port	EUB1-SLOW-2010	\$1486.64
						2 Power Receptacles, 1 Smart USB-A+C Charging	EUB1-SLOW-2100	1590.46
						3 Power Receptacles	EUB1-SLOW-3000	1486.64
8.25"(210mm)	3"(76mm)				4	2 Power Receptacles, 1 Cable Bay	EUB1-SLOW-2002	\$1576.60
						2 Power Receptacles, 2 Data Ports	EUB1-SLOW-2020	1576.60
						2 Power Receptacles, 1 Smart USB-A+C Charging, 1 Data Port	EUB1-SLOW-2110	1680.42
						2 Power Receptacles, 2 Smart USB-A+C Charging	EUB1-SLOW-2200	1784.24
						3 Power Receptacles, 1 Data Port	EUB1-SLOW-3010	1576.60
						3 Power Receptacles, 1 Smart USB-A+C Charging	EUB1-SLOW-3100	1680.42
						4 Power Receptacles	EUB1-SLOW-4000	1576.60
9.75"(248mm)	3"(76mm)				6	2 Power Receptacles, 2 Cable Bays	EUB1-SLOW-2004	\$1666.62
						2 Power Receptacles, 2 Data Ports, 1 Cable Bay	EUB1-SLOW-2022	1666.62
						2 Power Receptacles, 4 Data Ports	EUB1-SLOW-2040	1666.62
						2 Power Receptacles, 1 Smart USB-A+C Charging, 1 Data Port, 1 Cable Bay	EUB1-SLOW-2112	1770.44
						2 Power Receptacles, 1 Smart USB-A+C Charging, 3 Data Ports	EUB1-SLOW-2130	1770.44
						2 Power Receptacles, 2 Smart USB-A+C Charging, 1 Cable Bay	EUB1-SLOW-2202	1874.26
						2 Power Receptacles, 2 Smart USB-A+C Charging, 2 Data Ports	EUB1-SLOW-2220	1874.26
						2 Power Receptacles, 3 Smart USB-A+C Charging, 1 Data Port	EUB1-SLOW-2310	1978.08
						2 Power Receptacles, 4 Smart USB-A+C Charging	EUB1-SLOW-2400	2081.90
						3 Power Receptacles, 1 Smart USB-A+C Charging, 1 Cable Bay	EUB1-SLOW-3012	1666.62
						3 Power Receptacles, 3 Data Ports	EUB1-SLOW-3030	1666.62
						3 Power Receptacles, 1 Smart USB-A+C Charging, 1 Cable Bay	EUB1-SLOW-3102	1770.44
						3 Power Receptacles, 1 Smart USB-A+C Charging, 2 Data Ports	EUB1-SLOW-3120	1770.44
						3 Power Receptacles, 2 Smart USB-A+C Charging, 1 Data Port	EUB1-SLOW-3210	1874.26
						3 Power Receptacles, 3 Smart USB-A+C Charging	EUB1-SLOW-3300	1978.08
						4 Power Receptacles, 1 Cable Bay	EUB1-SLOW-4002	1666.62
4 Power Receptacles, 2 Data Ports	EUB1-SLOW-4020	1666.62						
4 Power Receptacles, 1 Smart USB-A+C Charging, 1 Data Port	EUB1-SLOW-4110	1770.44						
4 Power Receptacles, 2 Smart USB-A+C Charging	EUB1-SLOW-4200	1874.26						
5 Power Receptacles, 1 Data Port	EUB1-SLOW-5010	1666.62						
5 Power Receptacles, 1 Smart USB-A+C Charging	EUB1-SLOW-5100	1770.44						
6 Power Receptacles	EUB1-SLOW-6000	1666.62						

Electrical Components

Flush Mounted — Round

Flush Mounted — Round

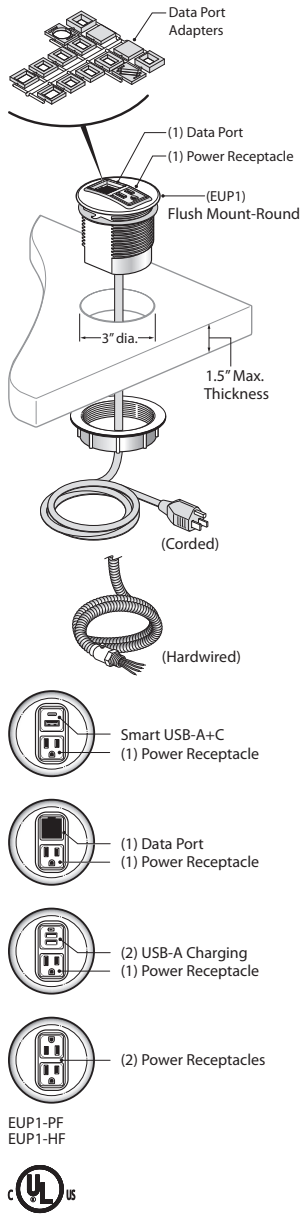

Cord Length	Port	Configuration	Number	Price
Corded				
6'(1829mm)	2	1 Power Receptacle, 1 Data Port	EUP1-PF0P-100010	\$314.70
		1 Power Receptacle, 1 Smart USB-A+C Charging	EUP1-PF0P-101000	479.96
		2 Power Receptacles	EUP1-PF0P-200000	321.90
10'(3048mm)	2	1 Power Receptacle, 1 Data Port	EUP1-PJ0P-100010	\$339.12
		1 Power Receptacle, 1 Smart USB-A+C Charging	EUP1-PJ0P-101000	504.38
		2 Power Receptacles	EUP1-PJ0P-200000	346.32
Hardwire				
6'(1829mm)	2	1 Power Receptacle, 1 Data Port	EUP1-HF0P-100010	\$415.70
		1 Power Receptacle, 1 Smart USB-A+C Charging	EUP1-HF0P-101000	580.96
		2 Power Receptacles	EUP1-HF0P-200000	422.90
10'(3048mm)	2	1 Power Receptacle, 1 Data Port	EUP1-HJ0P-100010	\$440.12
		1 Power Receptacle, 1 Smart USB-A+C Charging	EUP1-HJ0P-101000	605.38
		2 Power Receptacles	EUP1-HJ0P-200000	447.32

Features

- Includes power module with 2 ports configured with simplex outlets (NEMA-5-15R), USB charging port or data ports and mounting hardware.
- Power Modules specified with a data port includes a variety of data port adapters and blank covers, which accommodate most varieties of field supplied data/AV jacks.
- The Smart USB-A+C allows for the 20W to be transferred between the 2 ports. If the USB-A is being used, the full wattage is sent to the USB-A, and the same for the USB-C. If both are being used, the wattage is distributed to each port and the port drawing the most power will receive more watts than the one that is not.
- Corded power module with 15 amp - 6'(1829mm) or 10'(3048mm) long cord with plug (NEMA 5-15P).
- Hardwire power module with 6'(1829mm) or 10'(3048mm) long flexible galvanized metal conduit.
- Smart USB-A+C can provide fast charge for a mobile phone and tablets. Occupies one charging port.

To Order, Specify:

- 1) Product number.
- 2) Trim color.
 TR-PM1 Silver
 TR-PM2 Midnight Black
 TR-PM3 Parchment

Specification Tips

- Installs into a 3" diameter hole into surfaces with a maximum thickness of 1.5".
- Configuration and quantity of power and data ports cannot be modified in the field.
- For use with 120 volt 60 hertz power source only.
- Requires field installation.
- Specify AV cables separately.
- Application may require approval of local authority having jurisdiction (AHJ); ensure compliance before placing orders and installation.

EUP1-PF
EUP1-HF



Electrical Components

Wireless Charging Module

Wireless Charging Module

EUWC-PFOB-12002

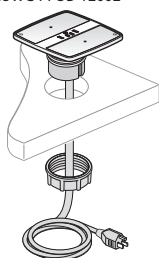

EUWC-PFOB
EUWC-PFOW
EUWC-HLOB
EUWC-HLOW



Features

- Includes power module with simplex outlet (NEMA-15R), two USB charging simplex and two wireless charging pads with soft touch plastic inserts and mounting hardware.
- 5 Watt wireless charging coil.
- Corded power module with 15 amp - 6'(1829mm) or 12'(3658mm) long cord with plug (NEMA 5-15P).
- Hardwired power module with 12'(3658mm) long flexible metal conduit feed, 0.5"(13mm) conduit fitting and wires for hardwire connection.
- USB Charging Port consists of one 5V USB 2.0 style A outlet. 2 Amp (shared) charging capacity.
- Attaches to 1"(25mm) to 1.5"(38mm) thick surface with use of included mounting brackets.
- Color option of black or white plastic face.

To Order, Specify:

- 1) Product number.
(No finish specification required.)

Specification Tips

- **Not for use with 2"(51mm) thick tops.**
- Configuration and quantity of power and USB ports cannot be modified in the field.
- For use with 120 volt 60 hertz power source only.
- Requires field installation.
- Requires field cut 3"(76mm) diameter access hole for power cord/conduit routing.
- Application may require approval of local authority having jurisdiction (AHJ); ensure compliance before placing orders and installation.
- Separately specified:
 - Horizontal and Vertical Wire Management

Width	Depth	Cord Length	Housing Color	Configuration	Number	Price
Corded						
7.38"(187mm)	7"(178mm)	6'(1829mm)	Black	1 Power Receptacle, 2 USB Charging, 2 Charging Pad	EUWC-PFOB-12002	\$1032.89
			White	1 Power Receptacle, 2 USB Charging, 2 Charging Pad	EUWC-PFOW-12002	1032.89
7.38"(187mm)	7"(178mm)	12'(3658mm)	Black	1 Power Receptacle, 2 USB Charging, 2 Charging Pad	EUWC-PL0B-12002	1114.25
			White	1 Power Receptacle, 2 USB Charging, 2 Charging Pad	EUWC-PL0W-12002	1114.25
Hardwire						
7.38"(187mm)	7"(178mm)	12'(3658mm)	Black	1 Power Receptacle, 2 USB Charging, 2 Charging Pad	EUWC-HLOB-12002	\$1216.23
			White	1 Power Receptacle, 2 USB Charging, 2 Charging Pad	EUWC-HLOW-12002	1216.23

Ergotron Keyboard Tray

	Description	Height Adjustment	Number	Price
Keyboard Tray with Mouse Pad	11"(279mm) Track	0" Above/6" Below	169BK	\$627.97
	18.5"(457mm) Track	0" Above/6" Below	UKMCBK	631.41

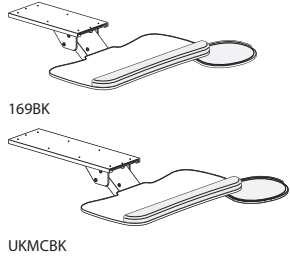

Features

- Includes: Keyboard tray with mouse pad and attachment hardware.
- Keyboard tray includes integrated foam wrist rest.
- Oval mouse extension pivots out from the right side.
- Height adjustment range: Level with to 6"(152mm) below worksurface.
- Tilt adjustment -20°/ +10°
- Pans 360°.
- Available with 11"(279mm) track or 18.5"(470mm) track.
- Weight capacity: 10 lbs.
- Black only.
- TAA Compliant.

To Order, Specify:

- 1) Product number.

Specification Tips

- Keyboard tray extends 4"(102mm) from front of worksurface when retracted.
- 11"(279mm) or 18.5"(470mm) under surface depth required for track installation.

Neo-Flex Keyboard Tray

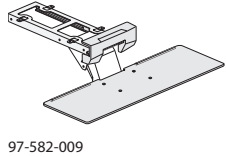

Keyboard Tray	0" Above/6" Below	97-582-009	\$336.53
---------------	-------------------	------------	-----------------

Features

- Includes: Keyboard tray, arm, desk clamp, slide mechanism and mounting hardware.
- Height adjustment range: Level with to 6"(152mm) below worksurface.
- Tilt adjustment +15°
- Fully retracts under worksurface when not in use.
- 26.9"(683mm)W x 8.9"(226mm)D keyboard trays allows room for keyboard and mouse.
- Weight capacity: 3 lbs.
- Keyboard tray extends approximately 9.25"(235mm) from front of surface.
- 15"(381mm) track.
- Black only.



To Order, Specify:

- 1) Product number.

Specification Tips

- Clamps to front edge of worksurface with clamp and one screw or remove clamp and attach under worksurface with four screws.
- Compatible with surfaces .75"(19mm) - 1.5"(25mm) thick.
- For use on surfaces with minimum depth of 17".

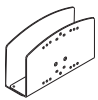
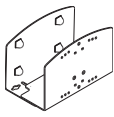
Ergotron CPU Holder

	Description	Number	Price	
Small CPU Holder  80-063	OBSOLETE 5/1/2024	Black	80-063-200	\$138.38
		White	80-063-216	138.38
Features <ul style="list-style-type: none"> Includes: One vertical steel CPU holder, mounting hardware and fasteners. Mounts to any sturdy vertical surface. CPU Holder is 6"(152mm)H x 10"(254mm)D. Accommodates CPUs 1.4"(25mm) to 3.75"(76mm) wide. Weight capacity: 50 lbs. 		To Order, Specify: 1) Product number.		
Universal CPU Holder  97-468		Silver	97-468-202	\$182.71
		White	97-468-216	182.71
Features <ul style="list-style-type: none"> Includes: One vertical steel CPU holder, mounting hardware and fasteners. Mounts to any sturdy vertical surface. CPU Holder is 6.6"(152mm)H x 10"(254mm)D. Accommodates CPUs 2"(51mm) - 8"(203mm) wide. Weight capacity: 40 lbs. 		To Order, Specify: 1) Product number.		
Cable CPU Holder  80-105-064		Grey/Silver	80-105-064	\$107.12
	Features <ul style="list-style-type: none"> Includes: One size-adjustable CPU holder and hardware. Mounts directly to wall or under worksurface. Size adjusts from 9.4"(229mm) x 2.6"(51mm) to 18"(457mm) x 8.5"(203mm). Unique security fasteners deter theft. Weight capacity: 50 lbs. 		To Order, Specify: 1) Product number.	

Ergotron Monitor Arms

HX Arm

Single Arm

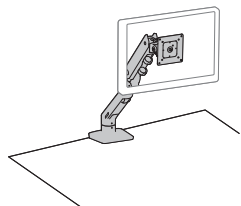

45-475
45-478

Description	Number	Price
Desk Mount		
Polished Aluminum	45-475-026	\$834.26
White	45-475-216	834.26
Matte Black	45-475-224	834.26
Wall Mount		
Polished Aluminum	45-478-026	\$834.26
White	45-478-216	834.26

Features

- Includes: Adjustable height monitor arm, extension, monitor pivot, mounting hardware.
 - Desk mount includes desk clamp and grommet mount.
 - Wall mount includes mounting hardware.
- For use with screen 49”(1245mm) or smaller.
- Weight capacity 20-42 pounds.
- Height adjustment range is 11.5”(292mm).
- Tilts 70° up and 5° down from center.
- 180° rotation base stop.
- Pans 180°.
- Rotates 360°.
- Extends out up to 25”(635mm).
- Integrated cable management.
- One touch adjustment.

To Order, Specify:

- Product number.

Specification Tips

- Desk clamp mounts on worksurface 0.4”(10mm)-2.5”(64mm) thick.
- Grommet mount attaches through surface holes 0.4”(10mm)-2”(51mm)W and up to 2.25”(57mm) thick.

Dual Arm

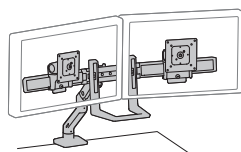

45-476
45-479

OBSOLETE
5/1/2024

Desk Mount		
Polished Aluminum	45-476-026	\$1358.18
White	45-476-216	1358.18
Matte Black	45-476-224	1358.18
Wall Mount		
Polished Aluminum	45-479-026	\$1358.18
White	45-479-216	1358.18

Features

- Includes: Adjustable height monitor arm, extension, two monitor pivots, hinged bow, handle, mounting hardware.
 - Desk mount includes desk clamp and grommet mount.
 - Wall mount includes mounting hardware.
- For use with screen 32”(813mm) or smaller.
- Weight capacity is 5-17.5 pounds per screen. Maximum combined weight is 35 pounds.
- Height adjustment range is 11.5”(292mm).
- Tilts 70° up and 5° down from center.
- 180° rotation base stop.
- Pans 180° - Hinged bow allows monitors to pan from left to right independently.
- Rotates 360°.
- Extends out up to 24”(610mm).
- Quick release monitor.
- Integrated cable management.
- One touch adjustment.
- Handle allows for easy positioning of multiple monitors simultaneously.

To Order, Specify:

- Product number.

Specification Tips

- Desk clamp mounts on worksurface 0.6”(15mm)-2.5”(64mm) thick.
- Grommet mount attaches through surface holes 0.4”(10mm)-2”(51mm)W and up to 2.25”(57mm) thick.

Ergotron Monitor Arms

HX Triple Monitor Bow Kit

Description	Number	Price
Polished Aluminum	98-009-026	\$801.74
White	98-009-216	801.74

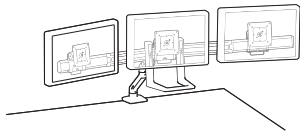
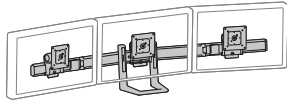

98-009-026
98-009-216

Features

- Includes: Triple monitor hinge bow, three monitor pivots, handle, monitor mounting hardware.
- For use with screen 24"(610mm) or smaller.
- Maximum weight capacity is 10.2 pounds per arm. Maximum combined weight is 30.6 pounds.
- Tilts 70° up and 5° down from center.
- Pans 180°.
- Rotates 360°.
- Extends out up to 24"(610mm).
- Quick release monitor.
- One touch adjustment.
- Handle allows for easy positioning of multiple monitors simultaneously.

To Order, Specify:

- 1) Product number.

Specification Tip

- Attaches to HX single or dual monitor arm.

Ergotron Monitor Arms

LX Desk Mount

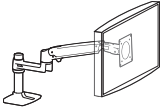
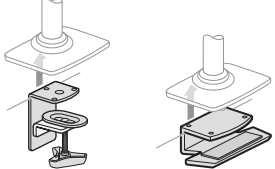
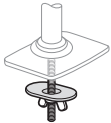
	Description	Number	Price
 <p>45-241 45-490 45-295 45-537 45-626</p>  <p>Two-Piece Clamp Low Profile C-Clamp</p>  <p>Grommet Mount</p>	Single Arm — Two-Piece Clamp		
	Polished Aluminum	45-241-026	\$390.24
	White	45-490-216	390.24
	Matte Black	45-241-224	390.24
	Single Arm — Low Profile C-Clamp		
	White	45-626-216	\$405.08
	Matte Black	45-626-224	405.08
	Single Arm — Tall Pole		
	Polished Aluminum	45-295-026	\$513.18
	White	45-537-216	513.18

Features

- Includes: Adjustable height monitor arm, pole, extension, two-piece clamp and grommet mount base (polished aluminum only) or low-profile top mount C-Clamp.
- Grommet mount base included on Polished Aluminum model only.
- Standard pole length is 8”(203mm). Tall pole length is 13.25”(337mm).
- Accommodates screens up to 34”(864mm) and 25 pounds.
- Height adjustment range is 13”(330mm) from installed height.
- Tilts 70° up and 5° down from center.
- Rotates 360°.
- Extends LCD's out up to 25”(635mm).
- Integrated cable management.
- One touch adjustment.

To Order, Specify:

- 1) Product number.

Specification Tips

- Desk clamp mounts on worksurface 0.4”(10mm)-2.4”(61mm) thick.
- Grommet mount attaches through surface holes 0.31”(8mm)-2”(51mm)W and up to 3”(76mm) thick.
- Low profile top mount C-Clamp mounts on worksurfaces 0.98”(25mm)-1.38”(35mm) thick.
- Mount type cannot be retrofitted in the field.

Dual Arm

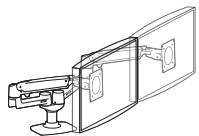

45-245
45-491

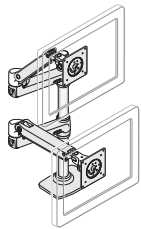

45-248
45-492

	Side-by-Side		
Polished Aluminum	45-245-026		\$786.35
White	45-491-216		786.35
Matte Black	45-245-224		786.35
	Stacking		
Polished Aluminum	45-248-026		\$786.35
White	45-492-216		786.35
Matte Black	45-492-224		786.35

Features

- Includes: Two adjustable height monitor arms, extensions, pole, grommet mount (polished aluminum only) and desk clamp.
- Grommet mount base available on Polished Aluminum model only.
- Screen size:
 - Side by Side application; screens 27”(686mm) or smaller.
 - Stacking application; screens 24”(610mm) or smaller. Screen height cannot exceed 14”(356mm) when stacking.
- Accommodates monitors from 7-20 pounds per arm. Maximum combined weight is 40 pounds.
- Height adjustment range is 13”(330mm).
- Tilts 70° up and 5° down from center.
- Pans 360°.
- Rotates 360°.
- Extends LCD's out up to 25”(635mm).
- Integrated cable management.
- One touch adjustment.

To Order, Specify:

- 1) Product number.

Specification Tips

- Desk clamp mounts on worksurface 0.4”(10mm)-2.4”(61mm) thick.
- Grommet mounts attached through surface holes 0.31”(8mm)-2”(51mm)W and up to 3”(76mm) thick.

Ergotron Monitor Arm

LX Monitor Arm — Tall Pole

	Description	Number	Price
LX Dual Stacking Arm - Tall Pole Monitor Arm	Polished Aluminum	45-549-026	\$789.13
	White	45-509-216	789.13

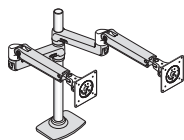

45-549-026
45-509-216

Features

- Includes: Two adjustable height monitor arms, extensions, 22”(559mm) pole, grommet mount, desk clamp and mounting hardware.
- Screen size:
 - Side by Side application; screens 40”(1016mm) wide or smaller.
 - Stacking application; screens 21”(533mm) high or shorter.
- Accommodates monitors from 7-20 pounds per arm. maximum combined weight is 40 pounds.
- Height adjustment range is 13”(330mm).
- Tilts 70° up and 5° down from center.
- Pans 360°.
- Rotates 360°.
- Extends LCDs out up to 25”(635mm).
- Integrated cable management.
- One touch adjustment.

To Order, Specify:

- 1) Product number.

Specification Tips

- Desk clamp mounts on worksurface 0.4”(10mm) - 2.4”(61mm) thick.
- Grommet mount attaches through surface holes .31”(8mm) - 2”(51mm) wide and up to 3”(76mm) thick.
- A third or fourth display can be added by ordering the LX Arm, Extension and Collar Kit. When adding a third or fourth monitor the maximum weight capacity per arm is 11 pounds.
- When using LX Arm Extension and Collar Kit with 3 monitors side by side, maximum screen width is 20.7” (526mm). When using LX Arm Extension and Collar kit with 4 monitors side by side, maximum screen width is 13.7” (348mm).
- For additional mounting options refer to page 129.

Ergotron Monitor Arm

LX Sit-to-Stand Mount

Single Arm

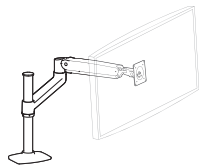

45-360-026
45-384-026

Description	Number	Price
LD — Light Duty		
Polished Aluminum	45-360-026	\$674.19
HD — Heavy Duty		
Polished Aluminum	45-384-026	\$896.05

Features

- Includes: Adjustable height monitor arm, extension, desk clamp and grommet base.
- Screen size:
 - LD - Light Duty for use with screen 42”(1067mm) or smaller.
 - HD - Heavy Duty for use with screen 46”(1168mm) or smaller.
- Monitor weight:
 - LD - Light Duty 7-25 pounds.
 - HD - Heavy Duty 14-30 pounds.
- Height adjustment range is 20”(508mm).
- Tilts 70° up and 5° down from center.
- Pans 360°.
- Rotates 90°.
- Extends LCD's out up to 33”(838mm).
- Integrated cable management.
- One touch adjustment.
- Locking connections between arm, extension and base provides theft deterrence and prevent potential disconnections caused by jarring or impacts.

To Order, Specify:

- 1) Product number.

Specification Tips

- Desk clamp mounts on worksurface 0.8”(20mm)-2.6”(66mm) thick.
- Grommet mounts attached through surface holes 0.5”(13mm)-2.5”(64mm) wide and up to 2.25”(57mm) thick.
- For additional mounting options refer to page 129.

Ergotron Monitor Arm

LX Desk Dual Direct

Dual Direct Arm

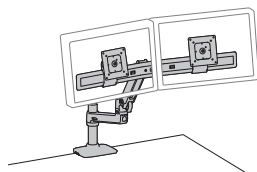

45-489
45-627

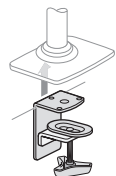

Two-Piece Clamp

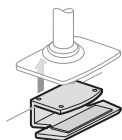

Low Profile C-Clamp

Description	Number	Price
Two-Piece Clamp		
Polished Aluminum	45-489-026	\$597.67
White	45-489-216	597.67
Matte Black	45-489-224	597.67
Low-Profile C-Clamp		
White	45-627-216	\$611.12
Matte Black	45-627-224	611.12

Features

- Includes: LX arm, extension, base, two-piece or low profile desk clamp, dual bow, two monitor pivots, 7”(178mm) pole and mounting hardware.
- For use with screens 25”(635mm) or smaller.
- Accommodates monitors from 2-11 pounds per monitor pivot. Maximum combined weight is 22 pounds.
- Height adjustment range is 13”(330mm).
- Each monitor has individual tilt of 15° up and 15° down from center.
- Pans 360°.
- Rotates 360°.
- Extends LCD's out up to 24”(610mm).
- Integrated cable management.
- One touch adjustment.
- Move two monitors simultaneously.

To Order, Specify:

- 1) Product number.

Specification Tip

- Two-Piece clamp mounts on worksurface 0.4”(10mm)-2.4”(61mm) thick.
- Low profile top mount C-Clamp mounts on worksurfaces 0.98”(25mm)-1.38”(35mm) thick.
- Mount type cannot be retrofitted in the field.

Dual Direct Handle Kit

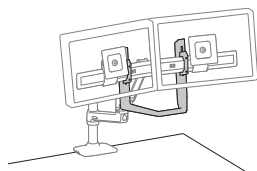

98-037-062

Polished Aluminum	98-037-062	\$130.70
-------------------	------------	-----------------

Features

- Includes: One handle and mounting hardware.
- For use with LX Dual Direct monitor arm.
- Allows repositioning of screens without touching the screen.

To Order, Specify:

- 1) Product number.

Ergotron Monitor Arm Accessories

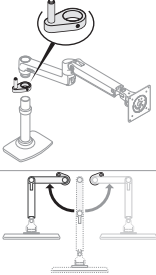

For use with LX Monitor Arms

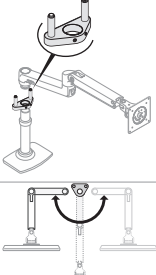
	Description	Number	Price
LX One-Stop Rotational Control Kit  <p>97-774-003</p>	Silver	97-774-003	\$37.62
	Features <ul style="list-style-type: none"> Includes: Single rotation stop collar, stop post, and hardware. Controls LX arm motion range to prevent extension arm from hitting the wall. 		To Order, Specify: <ol style="list-style-type: none"> Product number.
Specification Tips <ul style="list-style-type: none"> Compatible with LX Single Arm, LX Tall Pole Arm, LX Dual Stacking Arm, LX Dual Direct Arm and LX Dual Stacking Tall Pole arm. Not compatible with LX Dual Side by Side Arms or LX Sit-Stand arms. When used on LX Dual Stacking arm a quantity of two is needed. 			

LX Two-Stop Rotational Control Kit  <p>98-060-003</p>	Silver	98-060-003	\$47.85
	Features <ul style="list-style-type: none"> Includes: Dual rotation stop collar, two stop posts, and hardware. Provides a fixed 180° stop to prevent LX arm extension from hitting the wall. 		To Order, Specify: <ol style="list-style-type: none"> Product number.
Specification Tips <ul style="list-style-type: none"> Compatible with LX Single Arm, LX Tall Pole Arm, LX Dual Stacking Arm, LX Dual Direct Arm and LX Dual Stacking Tall Pole arm. Not compatible with LX Dual Side by Side Arms or LX Sit-Stand arms. 			

Ergotron Monitor Arm Accessories

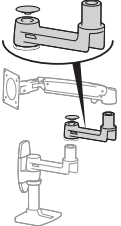
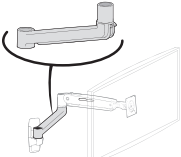
For use with LX Monitor Arms

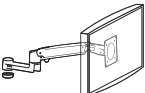
	Description	Number	Price
 <p>45-289-026</p>	<p>LX Extension</p> <p>Polished Aluminum</p> <p>Features</p> <ul style="list-style-type: none"> Includes: One extension. Add additional pivot-point for additional flexibility. Increases the reach of an LX arm by 9”(229mm). <p>Specification Tip</p> <ul style="list-style-type: none"> Only one extension to be used per monitor arm. 	45-289-026	\$97.91
	<p>To Order, Specify:</p> <p>1) Product number.</p>		
 <p>45-362-026</p>	<p>LX Sit-to-Stand Extension</p> <p>Polished Aluminum</p> <p>Features</p> <ul style="list-style-type: none"> Includes: One sit-to-stand extension. Add additional pivot-point for additional flexibility. Increases the reach of an LX Sit-to-Stand arm by 11.7”(297mm). <p>Specification Tip</p> <ul style="list-style-type: none"> Only one extension to be used per monitor arm. 	45-362-026	\$166.39
	<p>To Order, Specify:</p> <p>1) Product number.</p>		
 <p>97-844</p>	<p>LX Pole Collar</p> <p>Polished Aluminum</p> <p>Features</p> <ul style="list-style-type: none"> Includes: One collar and hardware. Used to attach a second LX Sit-to-Stand Arm at any point of an installed base. Reposition height on pole by loosening/tightening the collar's set screws. 	97-844	\$16.19
	<p>To Order, Specify:</p> <p>1) Product number.</p>		
 <p>97-940-026 98-130-216</p>	<p>LX Arm, Extension and Collar Kit</p> <p>Polished Aluminum</p> <p>Features</p> <ul style="list-style-type: none"> Includes: LX arm, extension, collar and hardware. Converts existing LX Tall Pole Arm to hold two monitors creating an LX Dual Stacking Arm configuration. Attaches to pole of the desk mount base. For use with screen 32”(813mm) or smaller. Weight capacity is 7-20 pounds. Height adjustment range is 13”(330mm). Tilts 70° up and 5° down from center. Pans 360°. Rotates 360°. Extends LCD's out up to 25”(635mm). Integrated cable management. One touch adjustment. <p>Specification Tip</p> <ul style="list-style-type: none"> Recommended for use with LX Desk Mount LCD Arm, Tall Pole. 	97-940-026	\$434.58
	<p>White</p> <p>98-130-216</p> <p>To Order, Specify:</p> <p>1) Product number.</p>	98-130-216	434.58

Ergotron Monitor Arm

MXV Desk Mount

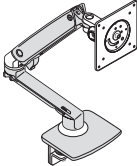
	Description	Number	Price
 <p>45-486 45-625</p>	Single Arm — Two-Piece Clamp		
	Polished Aluminum	45-486-026	\$439.71
	White	45-486-216	439.70
	Matte Black	45-486-224	439.70
	Single Arm — Low-Profile C-Clamp		
	White	45-625-216	\$456.35
Matte Black	45-625-224	456.35	

OBSOLETE
5/1/2024

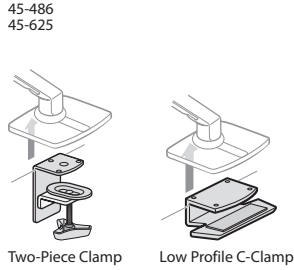

- Features**
- Includes: Fully assembled slim profile arm, two-piece desk clamp or low-profile C-clamp, and mounting hardware.
 - For use with screen 34"(864mm) or smaller.
 - Accommodates monitors from 7-20 pounds.
 - Height adjustment range is 13"(330mm).
 - Tilts 90° backward and 90° forward.
 - Rotates 360°.
 - Pans 180° at base; 360° between extension and arm. Rotation stop on base can be disengaged at time of installation to increase range to a full 360°.
 - Extends LCD monitor out 22.2"(559mm).
 - Arm folds back over base into a compact retracted position; perfect for tucking under systems furniture storage shelves or cabinets in space constrained areas.
 - Integrated cord management.
 - One touch adjustment.

To Order, Specify:
1) Product number.

- Specification Tips**
- Two-Piece clamp mounts on worksurface 0.47"(0mm) - 1.25"(25mm) thick.
 - Low profile top mount C-Clamp mounts on worksurfaces 0.98"(25mm)- 1.38"(35mm) thick.
 - Desk clamp has anti-rotation screws to prevent base from slipping.
 - Grommet mount available; separately specified part 98-110.

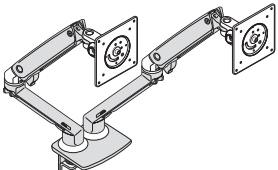
 <p>45-496</p>	Polished Aluminum	45-496-026	\$854.49
	White	45-496-216	854.50
	Matte Black	45-496-224	854.50

- Features**
- Includes: Fully assembled slim profile dual arm, two-piece desk clamp, and mounting hardware.
 - For use with screen 24"(610mm) or smaller. Screen size may affect adjustment capability.
 - Accommodates monitors from 7-20 pounds.
 - Height adjustment range is 13"(330mm).
 - Tilts 90° backward and 90° forward.
 - Rotates 360°.
 - Pans 180° at base; 360° between extension and arm. Rotation stop on base can be disengaged at time of installation to increase range to a full 360°.
 - Extends LCD monitor out 22.2"(559mm).
 - Arm folds back over base into a compact retracted position; perfect for tucking under systems furniture storage shelves or cabinets in space constrained areas.
 - Integrated cord management.
 - One touch adjustment.

To Order, Specify:
1) Product number.

- Specification Tips**
- Desk clamp mounts on worksurface .047"(0mm) - 1.25"(25mm) thick.
 - Desk clamp has anti-rotation screws to prevent base from slipping.
 - Grommet mount available; separately specified part 98-111.
 - For additional mounting options refer to page 129.

Ergotron Monitor Arms

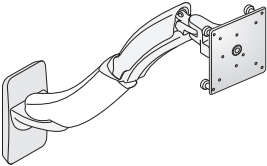

MX

	Description	Number	Price
 <p>45-214-026</p>	Polished Aluminum	45-214-026	\$506.88
	<p>Features</p> <ul style="list-style-type: none"> • Includes: Adjustable height monitor arm, desk clamp and grommet mount. • For use with screen 30”(762mm) or smaller. • Accommodates monitors from 14-30 pounds. • Height adjustment range is 5”(127mm). • Tilts 75° up and 5° down from center. • Rotates 90°. • Pans 360°. • Extends LCD's out up to 17”(432mm). • Integrated cable management. • One touch adjustment. <p>Specification Tips</p> <ul style="list-style-type: none"> • Desk clamp mounts on worksurface 0.4”(10mm)-2.5”(64mm) thick. • Grommet mounts attach through surface holes 0.31”(8mm)-2”(51mm) wide and up to 3”(76mm) thick. 	<p>To Order, Specify:</p> <p>1) Product number.</p>	

 <p>45-228-026</p>	Polished Aluminum	45-228-026	\$574.20
	<p>Features</p> <ul style="list-style-type: none"> • Includes: Arm with VESA adapter brackets, wall mount base and attachment hardware. • For use with screen up to 42”(1067mm). • Maximum weight capacity: 30 pounds. • Height adjustment range is 5”(127mm). • Tilts 75° up and 5° down. • Rotates 90° and includes position lock. • Pans 360°. • Integrated cable management. • One touch adjustment. <p>Specification Tips</p> <ul style="list-style-type: none"> • Recommended installation height: Upper mounting hole of base should be placed no higher than 60”(1524mm) above floor. 	<p>To Order, Specify:</p> <p>1) Product number.</p>	



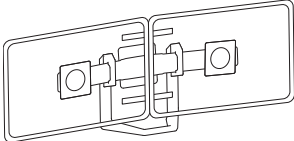

Ergotron Monitor Arm

Accessories

	Description	Number	Price
Dual Monitor and Handle Kit	Polished Aluminum/Black	97-783	\$267.32
 <p data-bbox="45 447 94 464">97-783</p>	<p>Features</p> <ul style="list-style-type: none"> Includes: Monitor bow, two monitor pivots, handle and mounting hardware. For use with screens 26" (660mm) or smaller. Maximum weight capacity is 18 pounds per arm. Maximum combined weight is 36 pounds. Rotates 360°. Arm in polished aluminum, bow and handle in black. 	<p>To Order, Specify:</p> <p>1) Product number.</p>	
	<p>Specification Tips</p> <ul style="list-style-type: none"> This product adds an additional 6 pounds to your mounting solution. Monitor arm's maximum weight capacity must be reduced by 6 pounds. Attaches to mounts with four-hole interface of 50 x 50 mm or 100 x 100 mm. 		
Monitor Quick Release LCD Bracket	Black	60-589-060	\$49.05
 <p data-bbox="45 856 123 873">60-589-060</p>	<p>Features</p> <ul style="list-style-type: none"> Includes: Bracket, screws and stand-offs. For use with monitors less than 3" (76mm) thick. Bracket weighs 1.2 pounds and is 0.5" (13mm) thick. Weight of the bracket needs to be considered when determining weight capacity of the monitor arm. 	<p>To Order, Specify:</p> <p>1) Product number.</p>	

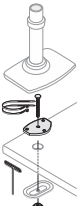
Ergotron Monitor Arm Accessories

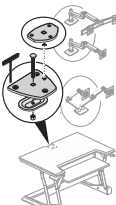
Grommet Mount

	Description	Number	Price
 <p>98-034</p>	Grommet Mount for LX Single and Dual Direct Arms	98-034	\$26.60
	<p>Feature</p> <ul style="list-style-type: none"> Includes: Grommet plate and attachment hardware. <p>Specification Tips</p> <ul style="list-style-type: none"> Compatible with LX Dual Direct Arm and the single monitor LX Desk Mount Arm (standard pole). Mounts through surface .31"(8mm) - 2"(51mm) wide and 3"(76mm) thick. 	<p>To Order, Specify:</p> <p>1) Product number.</p>	
 <p>98-035</p>	Grommet Mount for LX Dual Arm	98-035	\$39.91
	<p>Feature</p> <ul style="list-style-type: none"> Includes: Grommet plate and attachment hardware. <p>Specification Tips</p> <ul style="list-style-type: none"> Compatible with LX Dual Side-by-Side Arm and LX Dual Stacking Arm as well as Single Monitor LX Desk Mount Arm (tall pole). Mounts through surface .31"(8mm) - 2"(51mm) wide and 3"(76mm) thick. 	<p>To Order, Specify:</p> <p>1) Product number.</p>	
 <p>98-017</p>	Grommet Mount for LX Arm on WorkFit-T/TL	Zinc Plated Steel 98-017	\$38.87
	<p>Feature</p> <ul style="list-style-type: none"> Includes: Grommet plate and attachment hardware. <p>Specification Tips</p> <ul style="list-style-type: none"> Compatible with LX Dual Side-by-Side Arm and LX Dual Direct and LX Desk Mount Arm. Mounts through surface .31"(8mm) - 2"(51mm) wide and 3"(76mm) thick. Weight capacity: <ul style="list-style-type: none"> -LX Desk Mount Arm - 14 pounds -LX Dual Direct Arm - 4.8 pounds per monitor -LX Dual Side-by-Side Arm - 6 pounds per monitor Weight capacity is limited when mounting LX arms on WorkFit T/TL. 	<p>To Order, Specify:</p> <p>1) Product number.</p>	
 <p>98-110</p>	Grommet Mount for MXV Single Monitor Arm	98-110	\$26.37
	<p>Feature</p> <ul style="list-style-type: none"> Includes: Grommet plate and attachment hardware. <p>Specification Tips</p> <ul style="list-style-type: none"> Compatible with MXV Single Monitor Arm. Mounts through surface .31"(8mm) - 1.25"(32mm) wide and less than or equal to 1.3"(33mm) thick. 	<p>To Order, Specify:</p> <p>1) Product number.</p>	
 <p>98-111</p>	Grommet Mount for MXV Dual Monitor Arm	98-111	\$40.25
	<p>Feature</p> <ul style="list-style-type: none"> Includes: Grommet plate and attachment hardware. <p>Specification Tips</p> <ul style="list-style-type: none"> Compatible with MXV Dual Monitor Arm. Mounts through surface .31"(8mm) - 1.25"(32mm) wide and less than or equal to 1.3"(33mm) thick. 	<p>To Order, Specify:</p> <p>1) Product number.</p>	

Ergotron Monitor Arm Accessories

Top Mount Low Profile C-Clamp

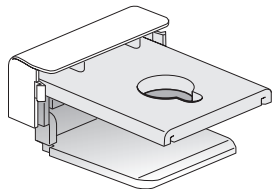

98-477
98-478

Feature

- Includes: One C-clamp and mounting hardware.

Specification Tips

- For use when installing current low-profile C-clamp monitor arm onto a different surface thickness.
- Cannot be used to retrofit monitor arms originally fitted with 2-piece clamps or grommet mounts.
- Compatible with LX Single and Dual Monitor Arms and MXV Monitor Arm.
- Requires open space of 0.8”(20mm) behind surface for installation.
- Part number is surface thickness and color specific; please plan according.

To Order, Specify:

- 1) Product number.

Description	Number	Price
Surface Thickness 0.47”(12mm)-0.71”(18mm)		
White	98-477-216	\$76.82
Matte Black	98-477-224	76.82
Surface Thickness 0.71”(18mm)-0.98”(25mm)		
White	98-478-216	\$76.82
Matte Black	98-478-224	76.82

Ergotron Monitor Mount

TRACE

Single Monitor

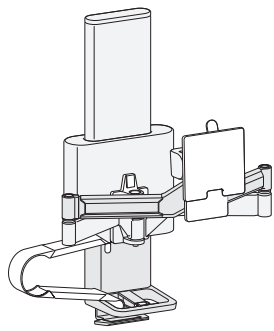

TDS-MA-PA-251

Features

- Includes lift column, extension arms, cable management channel, pivot, base, VESA spacer, mounting option and hardware.
- Mounting options include panel clamp, slim profile freestanding clamp or grommet mount.
- For use with screen up to 38”(965mm).
- Maximum weight capacity is 21.5 pounds.
- Height adjustment range is 11”(279mm).
- Tilts 75° up and 5° down.
- Rotates 360°.
- Pans 240°.
- Extension/retraction motion range is 15”(381mm).
- Integrated cable management.
- One touch adjustment.

To Order, Specify:

- 1) Product number.

Specification Tips

- Panel clamp attaches to surface edge up to 2.55”(65mm) thick.
- Slim profile clamp attaches to surface edge 0.47”(12mm)-1.26”(32mm) thick.
- Grommet clamp attaches through surface hole 0.31”(8mm)-2”(51mm)W and up to 2.56”(65mm) thick.

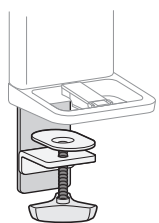

Panel Clamp
TDS-MA-PA



Freestanding Clamp
TDS-MA-FS

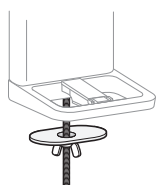

Grommet Mount
TDS-MA-GR

Description	Number	Price
Panel Clamp		
White	TDS-MA-PA-251	\$1091.27
Matte Black	TDS-MA-PA-224	1091.27
Slim Profile Freestanding Clamp		
White	TDS-MA-FS-251	\$1091.27
Matte Black	TDS-MA-FS-224	1091.27
Grommet Mount		
White	TDS-MA-GR-251	\$1091.27
Matte Black	TDS-MA-GR-224	1091.27

Ergotron Monitor Mount

TRACE

Dual Monitor

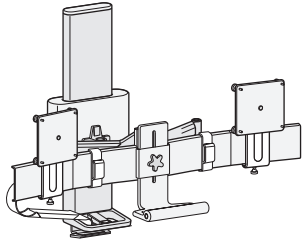

TDD-MA-PA

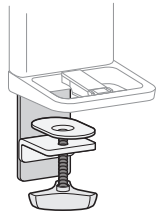

Panel Clamp
TDD-MA-PA

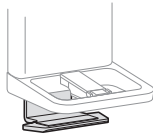

Freestanding Clamp
TDD-MA-FS

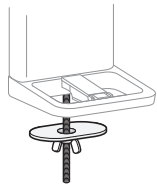

Grommet Mount
TDD-MA-GR

Features

- Includes lift column, extension arms, cable management channel, bow, two sliding pivots, base, VESA plates, mounting option and hardware.
- Mounting options include panel clamp, slim profile freestanding clamp or grommet mount.
- For use with screen up to 27"(686mm).
- Maximum weight capacity is 21.5 pounds total.
- Height adjustment range is 11"(279mm).
- Tilts 30° up and 5° down.
- Rotates 360°.
- Pans 240°.
- Extension/retraction motion range is 15"(381mm).
- Integrated cable management.
- One touch adjustment.

Specification Tips

- Panel clamp attaches to surface edge up to 2.55"(65mm) thick.
- Slim profile clamp attaches to surface edge 0.47"(12mm)-1.26"(32mm) thick.
- Grommet clamp attaches through surface hole 0.31"(8mm)-2"(51mm)W and up to 2.56"(65mm) thick.

To Order, Specify:

- 1) Product number.

Description	Number	Price
Panel Clamp		
White	TDD-MA-PA-251	\$1641.27
Matte Black	TDD-MA-PA-224	1641.27
Slim Profile Freestanding Clamp		
White	TDD-MA-FS-251	\$1641.27
Matte Black	TDD-MA-FS-224	1641.27
Grommet Mount		
White	TDD-MA-GR-251	\$1641.27
Matte Black	TDD-MA-GR-224	1641.27

Ergotron Monitor Mount Accessories

TRACE

Single Conversion Kit

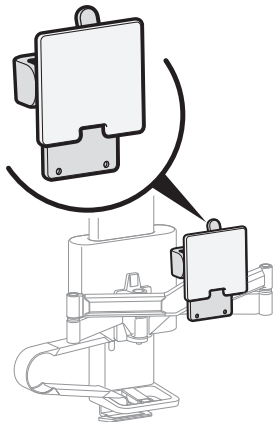

47-109-224

Features

- Includes tilting pivot and attachment hardware.
- Converts TRACE dual monitor mount configuration into a single monitor set-up.
- For use with screen up to 38”(965mm).
- Maximum weight capacity: 25.6 pounds.
- Tilts 75° up and 5° down.
- Rotates 360°.
- Pans 240°.

To Order, Specify:

- 1) Product number.

Description	Number	Price
Matte Black	47-109-224	\$279.37

Dual Conversion Kit

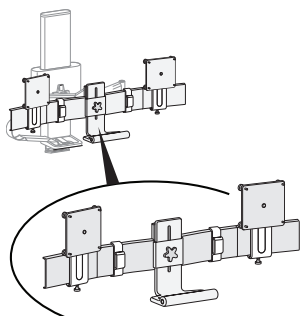

47-110-224

Features

- Includes bow, handle, two pivots and mounting hardware.
- Converts TRACE single monitor mount configuration into a dual monitor set-up.
- For use with screen up to 26”(660mm).
- Maximum weight capacity: 17.4 pounds. Maximum weight of 8.7 lbs per pivot.
- Tilts 30° up and 5° down.
- Rotates 360°.
- Pans 240°.

To Order, Specify:

- 1) Product number.

Description	Number	Price
Matte Black	47-110-224	\$558.73

Ergotron WorkFit-A — Single Attached Sit-Stand Workstation

Description	Height	Depth	Width	Number	Price
LD — Light Duty with WorkSurface					
Polished Aluminum/Black	42.7"(1085mm)	16.9"(429mm)- 43.7"(1110mm)	27"(686mm)	24-317-026	\$1295.45
LD — Light Duty with WorkSurface and Suspended Keyboard					
Polished Aluminum/Black	38.8"(986mm)	16.9"(429mm)- 43.7"(1110mm)	27"(686mm)	24-390-026	\$1357.31
HD — Heavy Duty with Worksurface and Suspended Keyboard					
Polished Aluminum/Black	38.8"(986mm)	16.9"(429mm)- 43.7"(1110mm)	27"(686mm)	24-391-026	\$1450.82

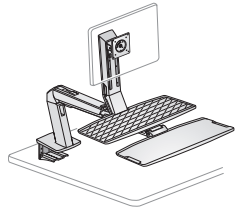

24-317-026
LD with WorkSurface

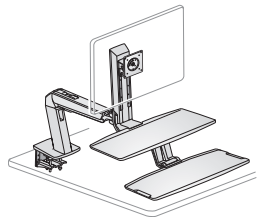

24-390-026
LD with Suspended Keyboard

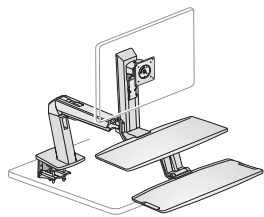

24-391-026
HD with Suspended Keyboard

Features

- Includes: Height-adjustment column, desk clamp, LCD pivot, keyboard tray, worksurface (when applicable) and hardware.
- Grommet mount included on models with suspended keyboard tray.
- Keyboard tray dimensions: 9.75"(248mm) D x 27"(686mm)W.
- Worksurface dimensions: 9.75"(248mm) D x 23"(584mm)W.
- Height adjustment range is 20"(508mm) with LCD and keyboard tray in tandem. LCD's adjust 5"(127mm) independently from worksurface. Maximum LCD height adjustment is 25"(635mm).
- Tilts 30°.
- Pans 180°.
- Rotates 90°.
- In seated position, suspended keyboard tray can drop down approximately 4"(102mm) below desktop surface.
- Integrated cable management.
- Black with polished aluminum arm extension and base.

To Order, Specify:

- 1) Product number.

Specification Tips

- Desk clamp mounts on worksurface up to 31.5"(800mm) deep and 0.78"(29mm)-2.6"(66mm) thick.
- Keyboard tray can be installed in three different positions: centered, offset right or offset left.

Description	Maximum Screen Size	Weight Capacity			
		Total	LCD	Keyboard Tray	Worksurface
LD with Worksurface	24"(610mm)	20 lbs.	5-15 lbs.	5 lbs.	5 lbs.
LD with Suspended Keyboard	24"(610mm)	20 lbs.	5-15 lbs.	5 lbs.	5 lbs.
HD with Suspended Keyboard	27"(686mm)	25 lbs.	10-20 lbs.	5 lbs.	5 lbs.

Ergotron WorkFit-A — Dual Attached Sit-Stand Workstation

Description	Height	Depth	Width	Number	Price
With Worksurface	42.7"(1085mm)	16.9"(429mm)- 43.7"(1110mm)	27"(686mm)	24-316-026	\$1424.91
With Worksurface and Suspended Keyboard	38.8"(986mm)	16.9"(429mm)- 43.7"(1110mm)	27"(686mm)	24-392-026	1482.54

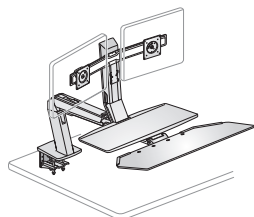

24-316-026

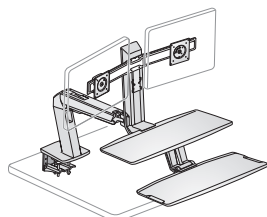

24-392-026

Features

- Includes: Arm, two LCD pivots, worksurface, crossbow, keyboard tray, desk clamp and hardware.
- For use with screen 24"(610mm) or smaller.
- Maximum weight capacity:
 - Total capacity 25 pounds
 - LCD - 4.5-10 pounds each.
 - Keyboard tray - 2 pounds
 - Worksurface - 5 pounds
- Keyboard tray dimension: 9.75"(248mm) D x 27"(686mm) W.
- In seated position, keyboard tray can drop down approximately 4"(102mm) below desktop surface.
- Worksurface dimension: 9.75"(248mm) D x 22.63"(575mm) W.
- Height adjustment range is 20"(508mm) with LCD and keyboard tray in tandem. LCD's adjust 5"(127mm) independently from worksurface. Maximum LCD height adjustment is 25"(635mm).
- Pans 180°.
- Rotates 360°.
- Integrated cable management.
- Black with polished aluminum extension and base.

To Order, Specify:

- 1) Product number.

Specification Tips

- Desk clamp mounts on worksurface up to 31.5"(800mm) deep and 0.5"(13mm) - 2.5"(64mm) thick.
- Minimum weight capacity of 12 pounds to ensure proper operation.
- Keyboard tray can be installed in three different positions: centered, offset right or offset left.

Ergotron WorkFit-C

Single Monitor

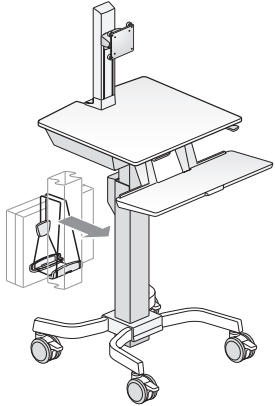

24-215-085
24-216-085

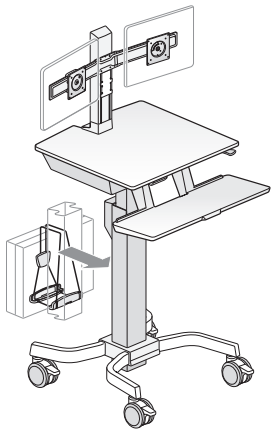

24-214-085

Features

- Includes cart, LCD mount(s), integrated worksurface, stowable keyboard tray, cable storage box, CPU holder, four dual casters (two locking), hand brake system and cable-winding bracket.
- Maximum screen size is 24"(610mm).
- Height adjustment range is 20"(508mm) with worksurface and keyboard tray in tandem. LCD adjusts 5"(127mm) independently; maximum LCD height adjustment 25"(635mm).
- Dimensions:
Worksurface: 23"(584mm)D x 24"(610mm)W
Keyboard tray: 9.4"D x 26.3"W
- Keyboard tray stows under worksurface.
- CPUs attach to rear of cart. Holder capacity 40 pounds.
- Tilt: LD and HD tilt 30°. Dual monitors do not tilt.
- Rotation: LD and Dual rotates 360° and HD rotates 90°.

To Order, Specify:

- 1) Product number.

Specification Tips

Description	Maximum Screen Size	Weight Capacity			
		Total	LCD	Keyboard Tray	Worksurface
LD	27"(686mm)	24.9 lbs.	16 lbs.	2 lbs.	5 lbs.
HD	30"(762mm)	32.5 lbs.	28 lbs.	2 lbs.	5 lbs.
Dual	24"(610mm)	32.5 lbs.	28 lbs.	2 lbs.	5 lbs.

Description	Height	Depth	Width	Number	Price
Single LD — Light Duty					
Black & Grey	14"(356mm)-19"(483mm)	23"(584mm)	26.3"(668mm)	24-215-085	\$2095.24
Single LD — Heavy Duty					
Black & Grey	14"(356mm)-19"(483mm)	23"(584mm)	26.3"(668mm)	24-216-085	\$2479.37
Dual Mount					
Black & Grey	14"(356mm)-19"(483mm)	23"(584mm)	26.3"(668mm)	24-214-085	\$2549.21

Ergotron WorkFit Corner — Standing Desk Converter

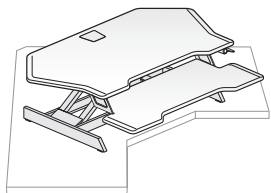

33-468-921

Features

- Includes: one height adjustable workstation with keyboard tray, cable management hardware and non-slip pads.
- For use with screen up to 30”(762mm).
- Maximum weight capacity: 35 pounds (worksurface up to 30 lbs; keyboard up to 5 lbs).
- Keyboard tray is positioned 4.5”(114mm) below worksurface.
- Worksurface and keyboard tray adjust 15”(381mm) in tandem.
- Dimensions:
 Worksurface: 23.6”(599mm)D X 44”(1118mm)W
 Keyboard Tray: 8.5”(216mm)D X 36”(914mm)W
- Unit weighs 59 pounds.
- Standard in Black.

To Order, Specify:

- 1) Product number.

Specification Tips

- Fits on desk surfaces 24”(610mm)D or larger.
- Monitor can be placed directly on the worksurface or monitor mount can be used.
- Ships fully assembled.

Description	Height	Depth	Width	Number	Price
Black	15”(381mm)	32”(813mm)	44”(1118mm)	33-468-921	\$1224.88

Ergotron WorkFit-LX — Sit-Stand Desk Mount System

Description	Number	Price
Polished Aluminum	45-405-026	\$1707.46

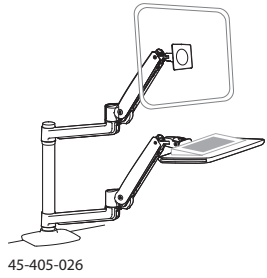

Features

- Includes: Monitor arm, two extensions, keyboard arm and tray, slide-out mouse tray, pole, two pole collars, desk clamp, grommet mount, VESA brackets, wrist rest and hardware.
- For use with screen 42”(1067mm) or smaller.
- Maximum weight capacity:
 - Monitor arm 7-25 pounds.
 - Keyboard arm 5 pounds.
- Keyboard tray dimensions: 8.9”(226mm) D x 18.3”(465mm) W.
- Keyboard tray tilts back 5°.
- Mouse tray dimensions: 8”(203mm) D x 8”(203mm) W.
- Height adjustment range is 20”(508mm).
- Side-to-Side movement range of 62”(1575mm).
- Arm extension is 33”(838mm).
- Tilts 75°.
- Pans 360°.
- Rotates 360°.
- Mouse Tray may be installed on the left or right side.

To Order, Specify:

- 1) Product number.

Specification Tips

- Desk clamp attaches to rear edge up to 2.5”(64mm) thick.
- Grommet mount attaches through hole 0.5”(13mm) to 2.5”(64mm) wide and up to 2.25”(57mm) thick.

Ergotron WorkFit-S — Single Attached Sit-Stand Workstation

Description	Height	Depth	Width	Number	Price
LD — Light Duty with WorkSurface					
Black	29.4(747mm)-35”(889mm)	16.3”(414mm)	27”(686mm)	33-350-200	\$1444.14
HD — Heavy Duty with Worksurface					
Black	29.4(747mm)-35”(889mm)	16.3”(414mm)	27”(686mm)	33-351-200	\$1634.73

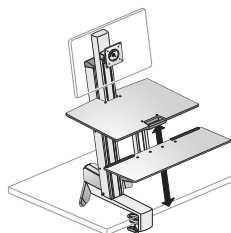

33-350-200

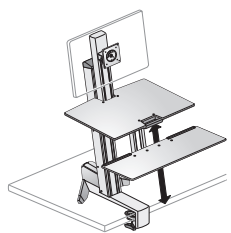

33-351-200

Features

- Includes: Height-adjustment column, desk clamp, LCD pivot, keyboard tray, and worksurface when applicable.
- Keyboard tray dimensions:
 - With Worksurface - 9”(229mm) D x 27”(686mm) W.
- Worksurface dimensions: 15”(381mm) D x 23”(584mm) W.
- Height adjustment range is 18”(457mm) with LCD and keyboard tray in tandem. LCD's adjust 5”(127mm) independently. Maximum LCD height adjustment is 23”(584mm).
- Tilts 30°.
- Rotation: LD rotates 360°. HD rotates 90°.
- Keyboard tray tilts back 5°.

To Order, Specify:

- 1) Product number.

Specification Tips

- Desk clamp mounts on front of worksurface 0.5”(13mm)-2.4”(61mm) thick.
- Height measured from desktop to lowest and highest positions.

Description	Maximum Screen Size	Weight Capacity			
		Total	LCD	Keyboard Tray	Worksurface
LD with Worksurface	24”(610mm)	24 lbs.	6-16 lbs.	5 lbs.	5 lbs.
HD with Worksurface	30”(762mm)	29 lbs.	16-28 lbs.	5 lbs.	5 lbs.

Ergotron WorkFit-S — Dual Attached Sit-Stand Workstation

Description	Height	Depth	Width	Number	Price
Without Worksurface					
Black	29.4(747mm)-35"(889mm)	16.3"(414mm)	24"(610mm)	33-341-200	\$1180.85
With Worksurface					
Black	29.4(747mm)-35"(889mm)	16.3"(414mm)	27"(686mm)	33-349-200	\$1527.45
White	29.4(747mm)-35"(889mm)	16.3"(414mm)	27"(686mm)	33-349-211	1540.89

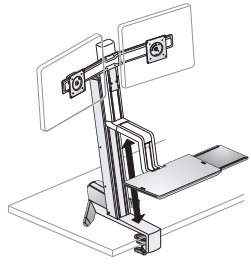

33-341-200

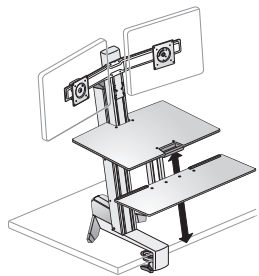

33-349-200
33-349-211

Features

- Includes: Height-adjustment column, desk clamp, crossbar, two LCD pivots, keyboard tray, and left/right mouse tray or worksurface when applicable.
- For use with screen 24"(610mm) or smaller.
- Maximum weight capacity:
 - Total capacity 31 pounds.
 - LCD - 6-14 pounds without worksurface. With worksurface LCD weight capacity 6-12 pounds..
 - Keyboard tray - 5 pounds.
 - Worksurface (when specified) - 5 pounds
- Keyboard tray dimensions:
 - Without Worksurface - 9.3"(236mm) D x 16.5"(419mm) W.
 - With Worksurface - 9"(229mm) D x 27"(686mm) W.
- Mouse tray available on without worksurface model only. May be installed on left or right side of keyboard tray. Dimensions: 7.9"(201mm) D x 7.5"(191mm) W.
- Worksurface dimensions: 15"(381mm) D x 23"(584mm) W.
- Height adjustment range is 18"(457mm) with LCD and keyboard tray in tandem. LCD's adjust 5"(127mm) independently. Maximum LCD height adjustment is 23"(584mm).
- Rotates 90°.
- Keyboard tray tilts back 5°.

To Order, Specify:

- 1) Product number.

Specification Tips

- Desk clamp mounts on front of worksurface 0.5"(13mm)-2.4"(61mm) thick.
- Height measured from desktop to lowest and highest positions.

Ergotron WorkFit-SR — Dual Attached Sit-Stand Workstation

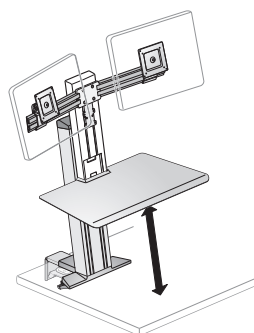

33-407-085
33-407-062

Description	Height	Depth	Width	Number	Price
Black	28.9(734mm)- 37”(940mm)	25.2”(640mm)	29.5”(749mm)	33-407-085	\$1789.56
White	28.9(734mm)- 37”(940mm)	25.2”(640mm)	29.5”(749mm)	33-407-062	1789.56

Features

- Includes: Height-adjustment column, crossbar, two LCD pivots, worksurface, one USB extension cable, two cable wraps and desk clamp.
- For use with screen 24”(610mm) or smaller.
- Maximum weight capacity:
 - Total capacity 25 pounds.
 - Monitor arm 3-11 pounds each.
 - Worksurface 5 pounds.
- Worksurface dimensions: 22”(559mm) D x 30”(762mm) W.
- Height adjustment range is 18”(457mm) with monitor and keyboard in tandem. Monitors lift independently 5”(127mm) additional.
- Tilts 35°.
- Rotates 360°.

To Order, Specify:

- 1) Product number.

Specification Tips

- Desk clamp attaches to rear of surfaces up to 2.5”(64mm) thick.
- Recommended for use on 30”(762mm)-36”(914mm) worksurfaces. Desks shorter than 30”(762mm) worksurface will extend beyond desktop edge. Desks deeper than 36”(914mm), worksurface will not extend to desktop edge.
- Height measured from desktop to lowest and highest positions.

Ergotron WorkFit-T — Desktop Sit-Stand Workstation

Description	Depth	Width	Number	Price
Black	25"(635mm)	35"(889mm)	33-397-085	\$1103.52

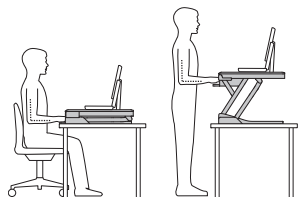
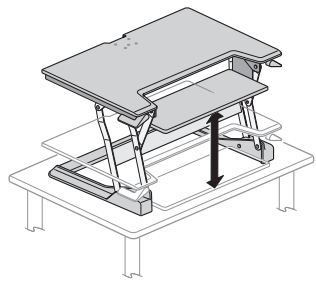

33-397-085
33-397-062

Features

- Includes: One height adjustable workstation with keyboard tray.
- For use with screen 30"(762mm) or smaller.
- Maximum weight capacity: 10-35 pounds.
- Keyboard tray dimensions are 25"(635mm) W x 9"(229mm) D.
- Total height adjustment range is 15"(381mm). Monitor and keyboard move in tandem.
- Keyboard tray sits 4.5"(114mm) below WorkFit worksurface.
- Ships fully assembled.

Specification Tips

- Fits on surfaces 24"(610mm) deep or larger including corner surfaces.
- Monitor can be placed directly on the worksurface or monitor mount can be used; sold separately.

To Order, Specify:

- 1) Product number.

Ergotron WorkFit-TL — Desktop Sit-Stand Workstation

Description	Depth	Width	Number	Price
Black	27"(686mm)	37.5"(953mm)	33-406-085	\$1137.09
Black - TAA Compliant	27"(686mm)	37.5"(953mm)	33-418-085	1773.79

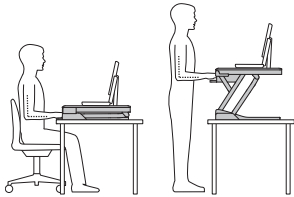
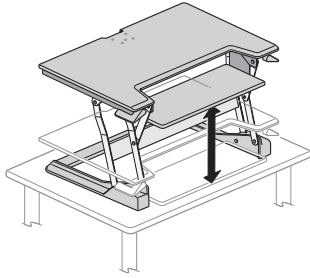

33-406-085
33-406-062
33-418-085

Features

- Includes: One height adjustable workstation with keyboard tray.
- TAA compliant version assembled in the USA in black only.
- For use with screen 30"(762mm) or smaller.
- Maximum weight capacity: 10-40 pounds.
- Keyboard tray dimensions are 27.5"(699mm) W x 11"(279mm) D.
- Total height adjustment range is 15"(381mm). Monitor and keyboard move in tandem.
- Keyboard tray sits 4.5"(114mm) below WorkFit worksurface.
- Ships fully assembled.

To Order, Specify:

- 1) Product number.

Specification Tips

- Fits on desks 24"(610mm) deep or larger.
- Monitor can be placed directly on the worksurface or monitor mount can be used; sold separately.

Ergotron WorkFit-TX — Standing Desk Converter

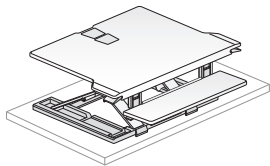

33-467-921

Features

- Includes: one height adjustable workstation with keyboard tray, cable management hardware and non-slip pads.
- For use with screen up to 30”(762mm).
- Maximum weight capacity: 40 pounds.
- Worksurface and keyboard tray adjust 17”(432mm) in tandem. Keyboard tray adjusts 3”(76mm) independently. Total adjustment range of 20”(508mm).
- Keyboard tray can be positioned as low as 3.5”(89mm) below worksurface.
- Dimensions:
 Worksurface: 27”(686mm)D X 32”(813mm)W
 Keyboard Tray: 8”(203mm)D X 28”(711mm)W
- Unit weighs 58.4 pounds.
- Standard in Black.

Specification Tips

- Fits on desk surfaces 24”(610mm)D or larger.
- Monitor can be placed directly on the worksurface or monitor mount can be used.
- Ships fully assembled.

To Order, Specify:

- 1) Product number.

Description	Height	Depth	Width	Number	Price
Black	19”(483mm)	27”(686mm)	32”(813mm)	33-467-921	\$1593.67

Ergotron WorkFit-Z Mini — Sit-Stand Desk Converter

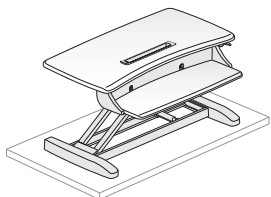

33-458-917

Features

- Includes: Desk converter with device slot and keyboard tray, leg covers, and cable ties.
- For use with screen 24"(610mm) or smaller.
- Maximum weight capacity: 25 pounds.
- Offers 12.5"(318mm) of click-free/noise free vertical lift. Maximum height 17.9"(455mm).
- Keyboard tray is 4.3"(109mm) below worksurface and moves in tandem with the worksurface.
- Dimensions:
 Worksurface: 15.8"(401mm)D X 31"(787mm)W
 Keyboard Tray: 9.1"(231mm)D X 24.5"(622mm)W
 Device Slot: 1.1"(28mm)D X 11"(279mm)W
- Unit weighs 34.3 pounds.
- Standard with dove grey woodgrain surface and black frame.

To Order, Specify:

- 1) Product number.

Specification Tips

- Fits on desk surfaces 22"(559mm)D or larger.
- Routes cables and cords with through-holes at bottom of device slot and behind keyboard tray.

Description	Height	Depth	Width	Number	Price
Grey Woodgrain/Black	5.4"(137mm)-17.9"(455mm)	16.3"(414mm)	31"(787mm)	33-458-917	\$671.28

Ergotron WorkFit — Accessories

WorkFit-A

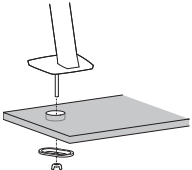
	Description	Number	Price
 <p>97-692</p>	Polished Aluminum/Black	97-692	\$70.16
	<p>Features</p> <ul style="list-style-type: none"> • Includes one grommet mount. • For use with WorkFit-A. • Black pole and hardware with polished aluminum base. 	<p>To Order, Specify:</p> <p>1) Product number.</p>	
	<p>Specification Tips</p> <ul style="list-style-type: none"> • Attaches through surface hole 0.5”(13mm) to 2.5”(64mm) wide and up to 2.6”(66mm) thick. • For maximum support, screw should be centered through hole. 		

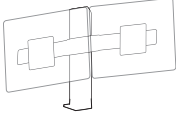
 <p>97-606</p>	Black	97-606	\$162.61
	<p>Features</p> <ul style="list-style-type: none"> • Includes: Crossbar, two monitor pivots and mounting hardware. • Converts WorkFit-A single HD workstation into a WorkFit Dual workstation. • For use with screens 24”(610mm) or smaller. • Pivots 360°. • LCD weight capacity is 6-14 pounds. • Total weight capacity is contingent on the WorkFit platform to which the kit is added. 	<p>To Order, Specify:</p> <p>1) Product number.</p>	
	<p>Specification Tips</p> <ul style="list-style-type: none"> • Compatible with WorkFit-A products. • Not for use with WorkFit-S. 		

Ergotron WorkFit — Accessories

WorkFit-S

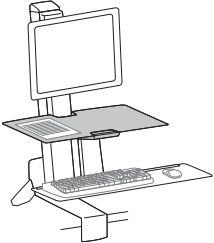
	Description	Height	Depth	Width	Number	Price
 <p>97-581-019</p>	Black	.25"(6mm)	15"(381mm)	23"(584mm)	97-581-019	\$244.02
	Features <ul style="list-style-type: none"> Includes: Worksurface, mounting brackets and mounting hardware. For use on WorkFit-S workstation. Weight capacity is 5 pounds. 					To Order, Specify: 1) Product number.
Specification Tips <ul style="list-style-type: none"> Does not affect normal range of WorkFit S. When added to WorkFit-S reduce total weight capacity by 6 pounds. May not be used in conjunction with Tablet/Document Holder. 						

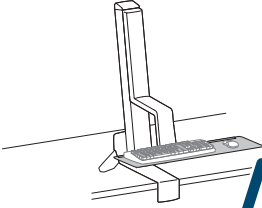
 <p>97-653</p>	Black	.25"(6mm)	9"(229mm)	27"(686mm)	97-653	\$133.93
	Features <ul style="list-style-type: none"> Includes: Keyboard tray and mounting hardware. For use on WorkFit-S workstation. Weight capacity is 5 pounds. 					To Order, Specify: 1) Product number.
Specification Tips <ul style="list-style-type: none"> May be installed on the workstation or offset to the right or left using alternate mounting holes. May be installed using only back mounting holes to increase distance between keyboard and monitor. 						

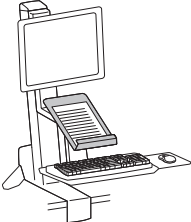
 <p>97-558-200</p>	Black	10.7"(272mm)	1.5"(38mm)	7.25"(184mm)	97-558-200	\$81.53
	Features <ul style="list-style-type: none"> Includes: document holder, handle and mounting hardware. For use with WorkFit-S. Maximum weight capacity: 2.2 pounds. 					To Order, Specify: 1) Product number.
Specification Tips <ul style="list-style-type: none"> Installation of this device may reduce WorkFit's 5"(127mm) independent height adjustment range for displays. When added to the WorkFit-S, total weight capacity of workstation is reduced by 1 pound. Not for use with WorkFit-S worksurface. 						

! OBSOLETE! May 2024

Ergotron WorkFit — Accessories

WorkFit-A / WorkFit-S

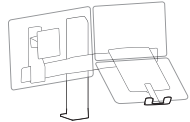
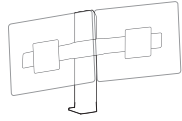
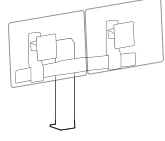
	Description	Number	Price
Conversion Kit: Dual to LCD & Laptop	<p>Black</p> <p>Features</p> <ul style="list-style-type: none"> • Includes: Laptop tray, riser bracket, monitor pivot and mounting hardware. • Converts WorkFit-S or WorkFit-A Dual workstation into a WorkFit LCD and laptop workstation. • For use with screens 24”(610mm) or smaller. • Monitor tilts 30°. • Pans 180°. • Monitor rotates 360°. • Weight capacity is contingent on the WorkFit platform to which the kit is added. 	97-617	\$166.19
 <p>97-617</p>	<p>To Order, Specify:</p> <p>1) Product number.</p>		
<p>Specification Tip</p> <ul style="list-style-type: none"> • Compatible with WorkFit-A or WorkFit-S workstation. 			
Conversion Kit: LCD & Laptop to Dual	<p>Black</p> <p>Features</p> <ul style="list-style-type: none"> • Includes: Two monitor pivots and mounting hardware. • Converts WorkFit-S or WorkFit-A LCD & Laptop workstation into a Dual Workstation. • For use with screens 22”(559mm) or smaller. • Rotates 360°. • Weight capacity is contingent on the WorkFit platform to which the kit is added. 	97-616	\$96.98
 <p>97-616</p>	<p>To Order, Specify:</p> <p>1) Product number.</p>		
Tall-User Kit for WorkFit Dual	<p>Black</p> <p>Features</p> <ul style="list-style-type: none"> • Includes: Two monitor pivots, two riser brackets and mounting hardware. • Converts WorkFit-S or WorkFit-A Dual display workstation to improve ergonomic height requirements of taller users. • For use with screens 24”(610mm) or smaller. • Maximum weight capacity: <ul style="list-style-type: none"> –Total capacity 28 pounds. –LCD – 6-14 pounds. • Rotates 360°. • Adds 30° of up/down tilt to displays. • Weight capacity is contingent on the WorkFit platform to which the kit is added. 	97-615	\$143.78
 <p>97-615</p>	<p>To Order, Specify:</p> <p>1) Product number.</p>		
<p>Specification Tip</p> <ul style="list-style-type: none"> • Compatible with WorkFit-S and WorkFit-A. Also works with Dual Monitor Kit for WorkFit-T. 			

Ergotron WorkFit — Accessories

WorkFit-A/WorkFit-S

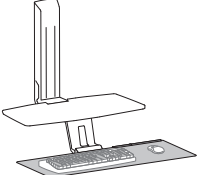
	Description	Height	Depth	Width	Number	Price
 <p>97-897</p>	Black	.25"(6mm)	11"(279mm)	27"(686mm)	97-897	\$163.64
	Features <ul style="list-style-type: none"> Includes: Large single piece keyboard tray and mounting hardware. Maximum weight capacity is 5 pounds. 		To Order, Specify: <ul style="list-style-type: none"> 1) Product number. 			
Specification Tips <ul style="list-style-type: none"> Compatible with WorkFit-S and WorkFit-A. Installs centered of offset to the right or left side. 						

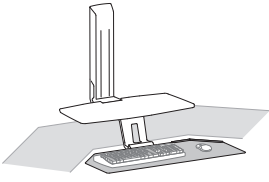
 <p>97-898</p>	Black	.25"(6mm)	11"(279mm)	27"(686mm)	97-898	\$163.61
	Features <ul style="list-style-type: none"> Includes: Corner single piece keyboard tray and mounting hardware. Maximum weight capacity is 5 pounds. 		To Order, Specify: <ul style="list-style-type: none"> 1) Product number. 			
Specification Tips <ul style="list-style-type: none"> Compatible with WorkFit-S and WorkFit-A. Installs centered of offset to the right or left side. 						

Ergotron WorkFit — Accessories

WorkFit-T/WorkFit-TL

	Description	Number	Price
WorkFit Single LCD Monitor Kit	Black	97-935-085	\$273.09
	White	97-935-062	265.95

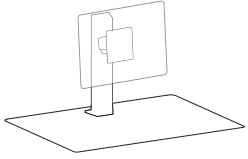

97-935

Features

- Includes: 5”(127mm) lift engine, one monitor pivot, dual bow, hardware, and cable management and ties.
- For use with screen 24”(610mm) or smaller.
- Maximum weight capacity: 6-16 pounds.
- Tilts 30°.
- Rotates 360°.

To Order, Specify:

- 1) Product number.

Specification Tips

- Compatible with WorkFit-T and WorkFit-TL, WorkFit-TLE, WorkFit-TX and WorkFit Corner.
- When added to a WorkFit workstation, overall capacity decreases by 6.6 pounds.

WorkFit Dual Monitor Kit	Black	97-934-085	\$406.38
	White	97-934-062	400.35

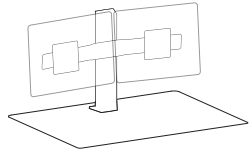

97-934

Features

- Includes: 5”(127mm) lift engine, two monitor pivots, dual bow, hardware, and cable management and ties.
- For use with screen 24”(610mm) or smaller.
- Maximum weight capacity:
 - Total weight 12-28 pounds.
 - LCD weight 6-14 pounds each.
- Rotates 360°.

To Order, Specify:

- 1) Product number.

Specification Tips

- Compatible with WorkFit-T and WorkFit-TL, WorkFit-TLE, WorkFit-TX and WorkFit Corner.
- When added to a WorkFit workstation, overall capacity decreases by 9.7 pounds.

WorkFit LCD & Laptop Kit	Black	97-933-085	\$399.40
	White	97-933-062	407.69

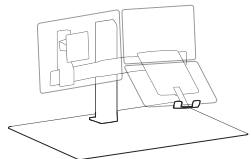

97-933

Features

- Includes: 5”(127mm) lift engine, one monitor pivot, one laptop tray, dual bow, hardware, and cable management and ties.
- For use with screen 24”(610mm) or smaller.
- Maximum weight capacity: 12-26 pounds.
 - LCD 6-16 pounds.
 - Laptop Tray 10 pounds.
- Monitor tilts 30°.
- Monitor rotates 360°.



To Order, Specify:

- 1) Product number.

Specification Tips

- Compatible with WorkFit-T and WorkFit-TL, WorkFit-TLE, WorkFit-TX and WorkFit Corner.
- When added to a WorkFit workstation, overall capacity decreases by 10 pounds.

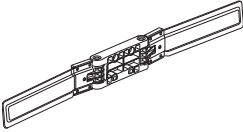
Ergotron Monitor Arm Accessories

	Description	Number	Price
 <p>98-101-009</p>	<p>Black</p> <p>98-101-009</p> <p>Price</p> <p>\$155.77</p>		
	<p>Features</p> <ul style="list-style-type: none"> Includes: Double-hinged bow and mounting hardware. For use with screens 25”(635mm) or smaller. Weight capacity is 6-14 pounds each. Capacity may vary depending on WorkFit capacity. Pans 168° from front to back using monitors 18”(457mm) or smaller. Panning motion may be restricted when using screens 19”(483mm) - 25”(635mm) in size. <p>Specification Tips</p> <ul style="list-style-type: none"> Compatible with WorkFit-A, WorkFit-S, WorkFit-SR dual workstations. Pivots are not included. Use pivots from current workstation. 	<p>To Order, Specify:</p> <p>1) Product number.</p>	
 <p>97-845</p>	<p>Black</p> <p>97-845</p> <p>Price</p> <p>\$42.38</p>		
	<p>Features</p> <ul style="list-style-type: none"> Includes: Bracket, recess spacer, and screws. Raises monitor 4”(102mm) - 6”(152mm). Screen size dependent on product to which it is attached. <p>Specification Tips</p> <ul style="list-style-type: none"> Compatible with WorkFit-S, WorkFit-A and WorkFit-T as well as any VESA mount where portrait/landscape adjustment is locked or not present. Kit adds one pound to the mount weight. De-rate weight capacity of accompanying mount by one pound. Monitor weight should never exceed 29 pounds. 	<p>To Order, Specify:</p> <p>1) Product number.</p>	

Ergotron WorkFit — Anti-Fatigue Floor Mat

	Height	Depth	Width	Number	Price
--	--------	-------	-------	--------	-------

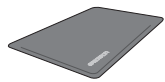

97-620-060

	6.25"(159mm)	24"(610mm)	36"(914mm)	97-620-060	\$549.95
--	--------------	------------	------------	------------	-----------------

Features

- Includes: One floor mat.
- 0.625"(16mm) thick.
- Custom blended medium density polyurethane foam.
- High tear strength polyurethane outer membrane.
- Black only.
- TAA (Trade Agreements Act) compliant.

To Order, Specify:

- 1) Product number.

Ergotron Neo-Flex Laptop Cart

Height	Depth	Width	Number	Price
26.6"(676mm)-46.6"(1184mm)	22.8"(579mm)	17.5"(445mm)	24-205-214	\$1958.36

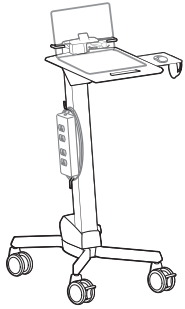

24-205-214
(power strip shown not included)

Features

- Includes: Integrated worksurface/keyboard tray with left/right mouse tray, scanner holder bracket, mouse holder, cable storage area, four dual casters (two locking), laptop security system, bracket for power strip and cable wrap.
- Compatible with most 12"(305mm)-17"(432mm) laptops. Maximum outside width of laptop is 18"(457mm).
- Maximum weight capacity is 15 pounds.
- Front handle on worksurface allows for easy mobility.
- 20"(508mm) height range adjustment allows for use from a seated or standing position.
- Worksurface dimensions 16.5"(419mm) W x 20.5"(521mm) D.
- Laptop cart standard in gray with 2 piece gray plastic worksurface.

To Order, Specify:

- 1) Product number.

Ergotron Teachwell® Mobile Digital Workspace

Height	Depth	Width	Number	Price
32"(813mm)-52"(1321mm)	24"(610mm)	31"(787mm)	24-220-055	\$1661.24

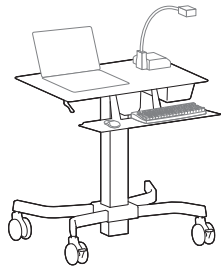

24-220-055

Features

- Includes: Cart, integrated phenolic worksurface, seamless keyboard/mousing tray, cable management box, cable winding brackets, four dual casters (two locking).
- Maximum weight capacity 38.5 pounds.
- Worksurface height adjustment range: 32"(813mm)-52"(1321mm).
Note: worksurface and keyboard tray adjust in tandem.
- Worksurface dimensions: 31"(787mm) W x 21"(533mm) D.
- Keyboard Tray: 26"(660mm) W x 9.4"(239mm) D stows under worksurface. Includes 5° back-tilt.
- Cable management box interior: 13.4"(340mm) W x 5"(127mm) D x 3.4"(86mm) H. Provides storage for one standard six-outlet power strip, two power bricks and the associated cables.
- Available in supplier graphite grey only.
- Includes mechanical mounting holes to mount many major document camera models. Ordered separately.
- Ships assembled.

To Order, Specify:

- 1) Product number.

Ergotron LearnFit

	Description	Height	Depth	Width	Number	Price
LearnFit Desk	Sit-Stand	29"(737mm)-44"(1118mm)	22"(559mm)	24"(610mm)	24-547-003	\$1004.70
	Standing	33"(838mm)-49"(1245mm)	22"(559mm)	24"(610mm)	24-481-003	1004.61

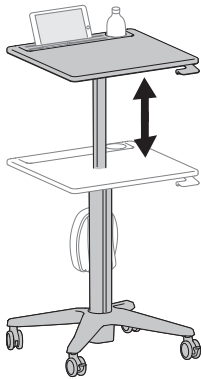

24-547-003
24-481-003

Features

- Includes: One adjustable height desk with two locking and 2 non-locking casters and backpack hook.
- PrecisionHeight™ Technology allows for one-touch height adjustment.
- Worksurface includes built in cup holder, tablet stand pocket and pencil tray.
- Maximum weight capacity for desk surface is 15 pounds.
- Sit-Stand desk height range is 29"(737mm)-45"(1143mm). Adjustable Standing desk height range is 33"(838mm)-49"(1245mm).
- Standard with polished aluminum column and base with feathered gray laminate surface. Edgeband and cup holder/pencil tray standard in dark gray.

To Order, Specify:

- 1) Product number.

Storage Bin	Dark Gray	8"(203mm)	8"(203mm)	14.5"(368mm)	97-926-064	\$100.75
--------------------	-----------	-----------	-----------	--------------	------------	-----------------

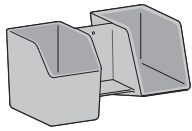

97-926-064

Features

- Includes: Molded plastic bins and mounting hardware.
- Sized to hold notebooks, folders and books.
- Smooth plastic surface.
- Maximum weight capacity is 8 pounds.
- Three separate compartments:
 - Enclosed, top-loaded on left side.
 - 3-sided, front-loaded on right side.
 - Smaller, 3-sided, front-loaded in center.

To Order, Specify:

- 1) Product number.

Specification Tips

- Compatible with LearnFit Adjustable Standing Desk
- Attaches at any height along the desk column.

Ergotron Zip 12 Charging

Height	Depth	Width	Number	Price
35.6"(904mm)	5.9"(150mm)	40.9"(1039mm)	DM12-1006-1	\$2609.26

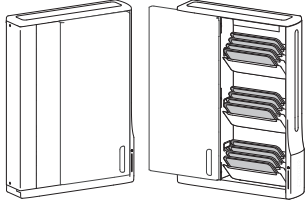

DM12-1006-1



- Features**
- Includes: Cabinet, 6' power cord, key and wall mounting hardware.
 - Charges and secures up to 12 tablets or notebooks with screens up to 12"(305mm).
 - Show & Stow™ technology tilting tablet trays fully retract/unload and automatically retract.
 - Sliding front door designed to work with oversized adapters. AC adapter maximum dimensions 4.1(104mm) H x 2"(51mm) W x 1.7(43mm) D.
 - Individual device maximum weight 3 pounds. Total weight capacity 44.4 pounds.
 - Contains one 12V DC continuous operation cooling fan.
 - Uses AC adapters that come with each device. AC adapters not included.
 - Black with polished aluminum sliding door and laptop tray fronts.
- To Order:** See Product Number.

OBSOLETE! May 2024

Grommets

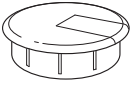
	Outside Diameter	Height	Hole Size	Number	Price
	3"(76mm)	1"(25mm)	2.75"(70mm)	WUAC-WSG	\$37.52

WUAC-WSG
Class CA – SIN 33721;
Discount Group I

Features

- Includes one grommet with removable cover.
- Must be field-installed.
- Available in black color only.

To Order, Specify:

- 1) Product number.
(No finish specification required.)

Specification Tip

- Works with top thickness 1" or greater.

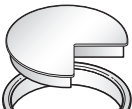
	Outside Diameter	Height	Hole Size	Number	Trim A	B
	3"(76mm)	1.125"(29mm)	2.75"(70mm)	WQAG-0303-PS	\$63.92	\$77.04
	3"(76mm)	2.0"(51mm)	2.75"(70mm)	WQAG-0303-PM	63.92	77.04

WQAG
Class IN – SIN 33721;
Discount Group IX

Features

- Includes one painted grommet with removable cover.
- Must be field-installed.

To Order, Specify:

- 1) Product number.
- 2) Trim color.

Specification Tip

- Works with top thickness:
 - WQAG-0303-PS - 1.18" or greater
 - WQAG-0303-PM - 2.0" or greater

	Outside Diameter	Height	Hole Size	Number	Price
	2.0"(51mm)	.75"(19mm)	1.75"(44mm)	JAG-1	\$29.21
	3.5"(89mm)	.75"(19mm)	3"(76mm)	JAG-2	\$33.69

JAG-1
Class TA – GSA: Open Market

Features

- Includes one grommet with removable cover.
- Must be field-installed.
- Available in black color only.

To Order, Specify:

- 1) Product number.
(No finish specification required.)



JAG-2
Class TA – SIN 33721;
Discount Group X

Specification Tip

- Works with top thickness 0.75" or greater.

	Outside Diameter	Height	Hole Size	Number	Trim A	B
	3"(76mm)	.72"(18mm)	2.75"(70mm)	TA01-0220	\$41.50	\$47.89

TA01-0220
Class TA – SIN 33721;
Discount Group X

Features

- Includes one painted grommet.
- Must be field-installed.

To Order, Specify:

- 1) Product number.
- 2) Trim color.

Specification Tip

- Works with 0.75" top or greater.

Grommets

Flip Top Unit — Hatch

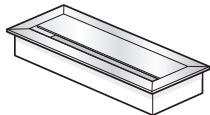

EUG1

Finishes	Bezel Width	Bezel Depth	Flip Top Unit Cutout Code	Configuration	Number	Price
Anodized						
	5.24"(133mm)	4.375"(111mm)	A, B	2	EUG1-0000-G2NNNW	\$254.07
	8.31"(211mm)		F, V	4	EUG1-0000-G4NNNW	269.95
	11.25"(286mm)		J, K	6	EUG1-0000-G6NNNW	285.84
Black						
	5.24"(133mm)	4.375"(111mm)	A, B	2	EUG1-0000-G2NNNB	\$333.47
	8.31"(211mm)		F, V	4	EUG1-0000-G4NNNB	349.35
	11.25"(286mm)		J, K	6	EUG1-0000-G6NNNB	365.24

Features

- Includes one flip top unit hatch.
- Hatch is flush mounted with spring release cover; 0.5"(13mm) gap between cover and bezel for cords.
- Available in anodized or black finish.
- Field installed.

To Order, Specify:

- 1) Product number.
(No finish specification required.)

Specification Tips

- Specify for cord management as needed.
- Order hatch to match cutouts specified for each table.

Information Display – Markerboard Accessories

	Description	Number	Price
Markerboard Accessories	Dry Erase Marker Kit (holder, six markers and eraser)	7062-8001	\$200.28
	Cleaner and Conditioner	7031-7001	239.12
	Spray Cleaner	7031-7002	72.99

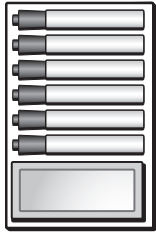

7062-8001



7031-7002



7031-7001

Feature

- Recommended dry erase marker products to maintain, clean & condition markerboard laminate.

To Order, Specify:

- 1) Product number
(No finish specification required.)

Lighting — Haworth

	Fixture Length	Total Length with Switch	Watts	Number	Price
Adaptable LED Task Light - Stand-Alone	17"(432mm)	18.6"(472mm)	5.6	LUTN-0017-19ULDN	\$244.53
	31"(787mm)	32.6"(828mm)	10.3	LUTN-0031-19ULDN	277.57
	44"(1118mm)	45.6"(1158mm)	14.3	LUTN-0044-19ULDN	308.25

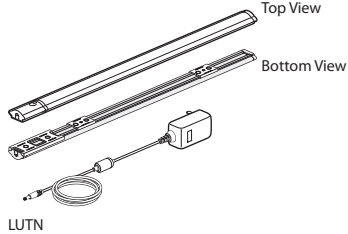

LUTN



Features

- Includes 17"(mm), 31"(787mm) or 44"(1118mm) LED fixture, one on/off/dimmer pack, 18 watt power supply with black nine foot power cord, two adhesive cord managers and screw/magnetic attachment hardware.
- Standard in anodized (silver) color with black caps.
- Height: 0.5"(12.7mm); Width: 1.18"(30mm).
- Automatic turn off after 12 hours (+/- 15 mins).

To Order, Specify:

- 1) Product number.
(No finish specification required.)

Specification Tips

- For use with 120 volt, 60 hertz electrical system.
- Color Temp: 3500K.
- Color Rendition Index: 85 CRI.
- Rated Lifespan: 52,000 hour.
- **Not intended for daisy chaining.**
- Single touch on/off with continuous dimming from 15-100% with last state memory.
- Intended for use under shelf or cabinet.

Adaptable LED Task Light - Starter Kit	17"(432mm)	18.6"(472mm)	5.6	LUTT-0017-11ULDN	\$277.41
	31"(787mm)	32.6"(828mm)	10.3	LUTT-0031-11ULDN	310.45
	44"(1118mm)	45.6"(1158mm)	14.3	LUTT-0044-11ULDN	341.13

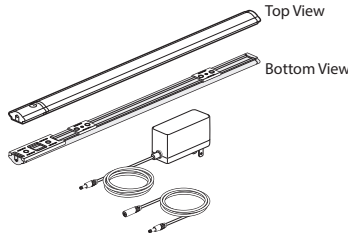

LUTT



Features

- Includes LED fixture, one on/off/dimmer pack, 40 watt power supply with eleven foot power cord, two adhesive cord managers, and screw/magnetic attachment hardware.
- Standard in anodized (silver) color with black caps.
- Height: 0.5"(12.7mm); Width: 1.18"(30mm).
- Automatic turn off after 12 hours (+/- 15 mins).

To Order, Specify:

- 1) Product number.
(No finish specification required.)

Specification Tips

- For use with 120 volt, 60 hertz electrical system.
- Color Temp: 3500K.
- Color Rendition Index: 85 CRI.
- Rated Lifespan: 52,000 hour.
- Refer to the Specification Guide or under the Adaptable LED Task Light - Add-on Kit for a chart showing the total number of light fixtures that can be daisy chained together.
- Single touch on/off with continuous dimming from 15-100% with last state memory.
- The on/off dimmer switch on the Starter Kit fixture will control all connected Add-On lights.
- Intended for use under shelf or cabinet.

Lighting — Haworth

	Fixture Length	Watts	Number	Price
Adaptable LED Task Light - Add-On Kit	17"(432mm)	5.6	LUTA-0017-1NULDN	\$205.92
	31"(787mm)	10.3	LUTA-0031-1NULDN	238.96
	44"(1118mm)	14.3	LUTA-0044-1NULDN	269.64

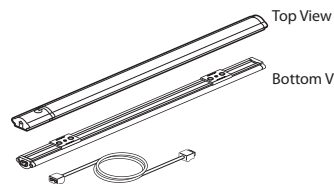

LUTA



Features

- Includes LED fixture, 18"(457mm) daisy chain cord, two adhesive cord mangers, and screw/magnetic attachment hardware.
- Standard in anodized (silver) color with black caps.
- Height: 0.5"(12.7mm); Width: 1.18"(30mm).

To Order, Specify:

- 1) Product number.
(No finish specification required.)

Specification Tips

- For use with 120 volt, 60 hertz electrical system.
- Color Temp: 3500K.
- Color Rendition Index: 85 CRI.
- Rated Lifespan: 52,000 hour.
- Refer to the chart below for the total number of light fixtures that can be daisy chained together.
- The on/off dimmer switch on the Starter Kit fixture will control all connected Add-On lights.
- Intended for use under shelf or cabinet.

Daisy Chair Combinations	# of 17" Lights	# of 31" Lights	# of 44" Lights
Combination 1	1	1	1
Combination 2	1	1	0
Combination 3	1	2	0
Combination 4	1	0	1
Combination 5	1	0	0
Combination 6	2	1	0
Combination 7	2	0	1
Combination 8	2	0	0
Combination 9	3	1	0
Combination 10	3	0	0
Combination 11	4	0	0
Combination 12	0	1	1
Combination 14	0	2	0
Combination 15	0	3	0
Combination 17	0	0	2

Lighting — Haworth

	Fixture Length	Watts	Number	Price
Reed Premier™ Stand-Alone LED Task Light	16.4"(417mm)	7.8	LUTS-0017-19ULD5	\$366.83

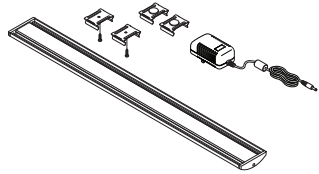

LUTS-0017-19ULD5



Features

- Includes 17"(432mm) LED fixture, 15 watt power supply with nine foot removable power cord.
- Standard in anodized (silver) color with white end caps.
- Height: 0.5"(12.7mm); Width: 2.0"(51mm); Length: 16.4"(417mm).

Specification Tips

- For use with 120 volt, 60 hertz electrical system.
- Color Temp: 3500K.
- Color Rendition Index: 84 CRI.
- Rated Lifespan: 5 0,000 hour.
- Not intended for daisy chaining.
- Single touch on/off with continuous dimming from 15-100%.
- Automatic shutoff after 10 hours.
- Includes screw and magnetic attachment hardware for steel, laminate and wood.
- Intended for use in horizontal applications.

To Order, Specify:

- 1) Product number.
(No finish specification required.)

Reed Premier™ Starter LED Task Light	16.4"(417mm)	7.8	LUTS-0017-12ULD6	\$ 504.40
	30.1"(765mm)	17.6	LUTS-0031-12ULD6	734.00
	43.7"(1110mm)	25.9	LUTS-0044-12ULD6	947.20
	57.4"(1458mm)	33.6	LUTS-0058-12ULD6	1176.80

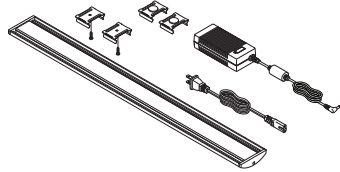

LUTS-0017-12ULD6



Features

- Includes LED fixture, 60 watt power supply with twelve foot removable power cord.
- Standard in anodized (silver) color with white end caps.
- Height: 0.5"(12.7mm); Width: 2.0"(51mm); Lengths: 16.4"(417mm), 30.1"(765mm), 43.7"(1110mm) or 57.4"(1458mm).

Specification Tips

- For use with 120 volt, 60 hertz electrical system.
- Color Temp: 3500K.
- Color Rendition Index: 84 CRI.
- Rated Lifespan: 5 0,000 hour.
- Refer to the Specification Guide for a chart showing the total number of light fixtures that can be daisy chained together.
- Single touch on/off with continuous dimming from 15-100%.
- Automatic shutoff after 10 hours.
- Includes screw and magnetic attachment hardware for steel, laminate and wood.
- Intended for use in horizontal applications.

To Order, Specify:

- 1) Product number.
(No finish specification required.)

Lighting — Haworth

	Fixture Length	Watts	Number	Price
Reed Premier™	16.4"(417mm)	7.8	LUTD-0017-1NULDN	\$ 366.83
Add-On LED Task Light —	30.1"(765mm)	17.6	LUTD-0031-1NULDN	596.43
For Use with Reed Premier Starter	43.7"(1110mm)	25.9	LUTD-0044-1NULDN	809.63
LED Task Lights	57.4"(1458mm)	33.6	LUTD-0058-1NULDN	1039.23

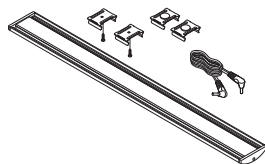

LUTD-0017-1NULDN



Features

- Includes LED fixture, 8"(203mm) and 30"(762mm) daisy chain cord.
- Standard in anodized (silver) color with white end caps.
- Height: 0.5"(12.7mm); Width: 2.0"(51mm); Lengths: 16.4"(417mm), 30.1"(765mm), 43.7"(1110mm) or 57.4"(1458mm).

To Order, Specify:

- 1) Product number.
(No finish specification required.)

Specification Tips

- For use with 120 volt, 60 hertz electrical system.
- Color Temp: 3500K.
- Color Rendition Index: 84 CRI.
- Rated Lifespan: 5 0,000 hour.
- Refer to the Specification Guide for a chart showing the total number of light fixtures that can be daisy chained together.
- Single touch on/off with continuous dimming from 15-100%.
- Automatic shutoff after 10 hours.
- Includes screw and magnetic attachment hardware for steel, laminate and wood.
- Intended for use in horizontal applications.

Reed Premier™ Add-On Occupancy Sensor

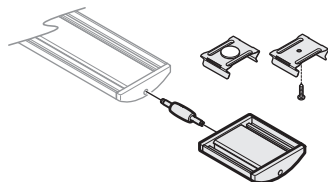

LUTS-0000



LUTS-0000

\$412.73

Features

- Includes occupancy sensor and attachment connector.
- Standard in anodized (silver) color with white end caps.
- Height: 0.7"(17.8mm); Width: 2.0"(51mm); Length: 2.3"(58mm).

To Order, Specify:

- 1) Product number.
(No finish specification required.)

Specification Tips

- For use with 120 volt, 60 hertz electrical system.
- Includes screw and magnetic attachment hardware for steel, laminate and wood.
- Intended for use in horizontal applications.

Lighting — Haworth

Voyage without Occupancy Sensor

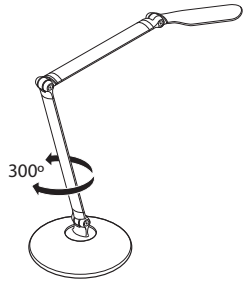

LUV1



Features

- Includes base, adjustable arm fixture with LED light and 6'(182cm) removable cord.
- Available in supplier silver, white or black.
- Touch controls for On/Off switching and continuous 100-15% dimming.
- Arm rotates 300°.
- Base footprint: 6"(152mm) diameter.
- Clamp mount can be used on horizontal surfaces from 0.90"(23mm) to 1.87"(47mm) thick.
- Auto turn off after 10 hours of use.
- Power consumption: 7W.
- Color temperature 3500k.
- Luminosity: 250 Lumens.
- Color Rendition Index: 84 CRI.
- 50K hour lifespan.
- Cord length: 6'(182cm).

Specification Tips

- Minor assembly required.
- **For use with 120 volt 60 hertz electrical system.**

Number

LUV1-0012-07 LC

Price

\$795.53

To Order, Specify:

1) Product number, including:

① Attachment:

F Freestanding

G Clamp

2) Trim color.

TR-11 Black

TR-12 Silver

TR-13 White

Voyage with Occupancy Sensor

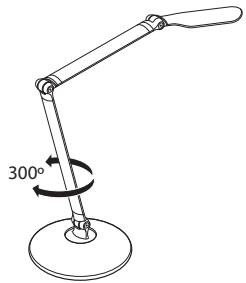

LUV2



Features

- Includes base, adjustable arm fixture with LED light and 6'(182cm) removable cord.
- Available in supplier silver, white or black.
- Touch controls for On/Off switching and continuous 100-15% dimming.
- Arm rotates 300°.
- Base footprint: 6"(152mm) diameter.
- Clamp mount can be used on horizontal surfaces from 0.90"(23mm) to 1.87"(47mm) thick.
- Power consumption: 7W.
- Color temperature 3500k.
- Luminosity: 250 Lumens.
- Color Rendition Index: 84 CRI.
- 50K hour lifespan.
- Cord length: 6'(182cm).

Specification Tips

- Minor assembly required.
- **For use with 120 volt 60 hertz electrical system.**

LUV2-0012-07 LO

\$1169.92

To Order, Specify:

1) Product number, including:

① Attachment:

F Freestanding

G Clamp

2) Trim color.

TR-11 Black

TR-12 Silver

TR-13 White

Lighting — Haworth Collection

Brazo

	Base Diameter	Model	Number	Price
Freestanding Lighting	8.5"(216mm)	Table Light	LBJ1-0026-19FLC	\$550.00
		Floor Light	LBJ2-0026-19FLC	650.00

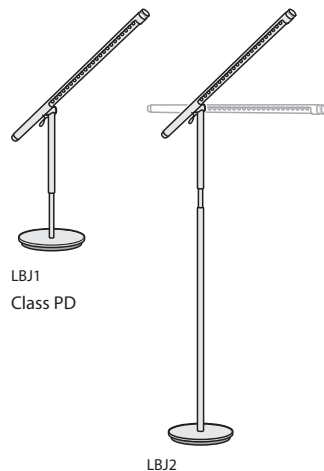

LBJ1
Class PD

LBJ2



Features

- Includes base, adjustable height fixture, 26.5"(673mm) arm with LED light and clear lens, nine foot removable silvertone cord.
- Available in Brushed Aluminum, Gloss White or Anodized Black finish colors.
- Features a LED light source with full dim control knob located on end of arm and 90° disbursement adjustment.
- 1.5 to 9 watts.
- Arm rotates 360°.
- Table light adjustable height fixture range is 14"-22"(356mm-559mm) from desktop.
- Floor light adjustable height fixture range is 48"-56"(1219-1422mm) from floor.
- Base includes scratch-resistant bottom cover with side cord location.
- Table light overall height range with arm extended at 180° is 41"(1041mm).
- Floor light overall height range with arm extended at 180° is 74.75"(1899mm).

Specification Tips

- Minor assembly required.
- **For use with 120 volt 60 hertz electrical system.**

To Order, Specify:

1) Product number, including:

1 Finish Color

- N** Brushed Aluminum
- W** Gloss White
- B** Anodized Black

	Grommet/Hole Diameter	Model	Number	Price
Mounted Lighting	3"(76mm)	Grommet Mounted Light	LBJ3-0026-19GLC	\$515.00
	1"(25mm)	Worksurface Mounted Light	LBJ4-0026-19GLC	515.00

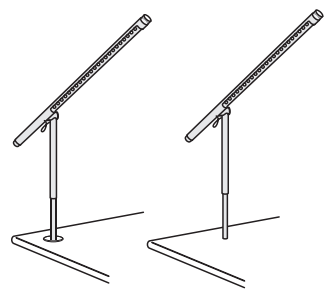

LBJ3
Class PD

LBJ4



Features

- Grommet Mount includes adjustable height fixture, 26.5"(673mm) arm with LED light and clear lens, nine foot removable silvertone cord and attachment hardware. **Grommet ordered separately.**
- Worksurface Mount includes adjustable height fixture, 26.5"(673mm) arm with LED light and clear lens, nine foot removable silvertone cord and attachment hardware with trim ring.
- Available in Brushed Aluminum, Gloss White or Anodized Black finish colors.
- Features a LED light source with full dim control knob located on end of arm and 90° disbursement adjustment.
- 1.5 to 9 watts.
- Arm rotates 360°.
- Both mounted light adjustable height fixture range is 13"-21"(330mm-533mm) from desktop.
- Overall height range with arm extended at 180° is 40"(1016mm).

Specification Tips

- **Grommet Mount Brazo requires a separately specified grommet.**
- Field drilling of surface required.
- Minor assembly required.
- **For use with 120 volt 60 hertz electrical system.**

To Order, Specify:

1) Product number, including:

1 Finish Color

- N** Brushed Aluminum
- W** Gloss White
- B** Anodized Black

2 Worksurface Thickness

- S** 1.19"(30mm)
- M** 2"(51mm)
- Q** 3"(76mm)

	Top Thickness	Number	Price
Grommet — For Use with Brazo Grommet Mounted Light Only	1.19"(30mm)	WQAG-0303-PSN	\$40.00
	2"(51mm)	WQAG-0303-PMN	40.00
	3"(76mm)	WQAG-0303-PQN	40.00



WQAG
Class PT

Feature

- Includes one 3"(76mm) diameter grommet without cover.

Specification Tips

- Specify grommet to match product top thickness.
- Requires a 2.75"(70mm) diameter field drilled hole.
- For use with Brazo Grommet Mounted Light only.

To Order, Specify:

1) Product number.

2) Trim color.

- TR-TW Plaster
- TR-LE Metallic Silver
- TR-MC Metallic Champagne

Lighting — Haworth Collection

Circa

	Description	Number	Price
Table Light	Table Light	LRT1-1408	\$550.00
	Grommet Mounted Light	LRT1-1408-G	550.00

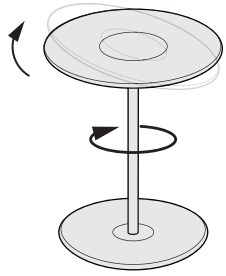

LRT1-1408



Features

- Includes base, aluminum stem, lamp shade with LED flat panel light, polycarbonate lens assembly and 8' fabric wrapped cord.
- Grommet mounted base includes attachment hardware with grommet.
- Base: 10"(254mm) diameter plastic with a steel insert and built-in USB charging port.
- 12"(305mm) diameter flat panel lamp shade is plastic with a polycarbonate lens assembly.
- Lamp shade rotates 360° and tilts 45° in two directions.
- Stem 14"(356mm) high.
- Features a LED light source with full range dim control.
- 9 watts.

To Order, Specify:

- 1) Product number.
- 2) Trim color.
TR-R01 Graphite
TR-R02 White

Specification Tips

- **For use with 120 volt 60 hertz electrical system.**
- Minor assembly required.

Floor Light

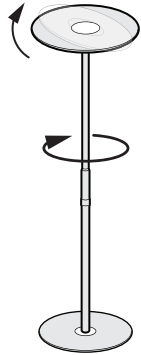

LRF0-5208



LRF0-5208

\$825.00

Features

- Includes base, aluminum stem, lamp shade with LED flat panel light, polycarbonate lens assembly and 8' fabric wrapped cord.
- Base: 14"(356mm) diameter base is plastic with a steel insert.
- 16"(406mm) diameter flat panel lamp shade is plastic with a polycarbonate lens assembly.
- Lamp shade rotates 360° and tilts 45° in two directions.
- Stem 52"(1321mm) high with built-in USB port.
- Features a LED light source with full range dim control.
- 11 watts.

To Order, Specify:

- 1) Product number.
- 2) Trim color.
TR-R01 Graphite
TR-R02 White

Specification Tips

- **For use with 120 volt 60 hertz electrical system.**
- Minor assembly required.

Lighting — Haworth Collection

Contour

Table Light

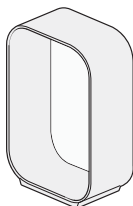

LCT1-1708



Description	Height	Depth	Width	Number	Price
Small Table Light					
Fabric Interior	17.5"(445mm)	6"(152mm)	12"(305mm)	LCT1-1708	\$475.00
Wood Interior	17.5"(445mm)	6"(152mm)	12"(305mm)	LCT1-1708	475.00
Large Table Light					
Fabric Interior	25"(635mm)	6"(152mm)	13"(330mm)	LCT2-2508	\$550.00
Wood Interior	25"(635mm)	6"(152mm)	13"(330mm)	LCT2-2508	550.00

Features

- Includes one aluminum body construction light with polycarbonate lens assembly, USB charging port and 8' fabric wrapped cord.
- Full range dim control for glare free, high output LED light.
- Base: Plastic with built-in USB charging port. Interior of light is lined with wood veneer or fabric.
- 8 watts.
- Available in the following colors:
 - Fabric Interior
 - Graphite Exterior, Coal Interior (TR-C04)
 - White Exterior, Pearl Interior (TR-C07)
 - Wood Interior
 - Graphite Exterior, Walnut Interior (TR-C05)
 - Graphite Exterior, White Oak Interior (TR-C06)
 - White Exterior, Walnut Interior (TR-C08)
 - White Exterior, White Oak Interior (TR-C09)

To Order, Specify:

- 1) Product number.
- 2) Trim color.

Specification Tip

- For use with 120 volt 60 hertz electrical system.

Floor Light



LCF1-6009



Fabric Interior	60"(1524mm)	8"(203mm)	13"(330mm)	LCF1-6009	\$825.00
Wood Interior	60"(1524mm)	8"(203mm)	13"(330mm)	LCF1-6009	825.00

Features

- Includes one aluminum body construction light with polycarbonate lens assembly, USB charging port and 9' fabric wrapped cord.
- Full range dim control for glare free, high output LED light.
- Base: Plastic with built-in USB charging port. Interior of light is lined with wood veneer or fabric.
- 21.5 watts.
- Available in the following colors:
 - Fabric Interior
 - Graphite Exterior, Coal Interior (TR-C04)
 - White Exterior, Pearl Interior (TR-C07)
 - Wood Interior
 - Graphite Exterior, Walnut Interior (TR-C05)
 - Graphite Exterior, White Oak Interior (TR-C06)
 - White Exterior, Walnut Interior (TR-C08)
 - White Exterior, White Oak Interior (TR-C09)

To Order, Specify:

- 1) Product number.
- 2) Trim color.

Specification Tip

- For use with 120 volt 60 hertz electrical system.

Lighting — Haworth Collection

Giraffa

	Description	Height	Depth	Width	Number	Price
Table Light	Standard Trim	13"(330mm)	2.25"(57mm)	7"(178mm)	HCPL-GFT1-13	\$325.00
	Premium Trim				HCPL-GFT1-13	325.00

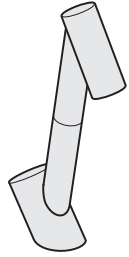

HCPL-GFT1-13



Features

- Includes one high output LED light with aluminum body and polycarbonate lens assembly, and 6' fabric cord.
- Integrated touch switch control.
- Full range dimming built into the base.
- Light source rotates 360°.
- 4.6 watts.

To Order, Specify:

- 1) Product number.
- 2) Trim color.
TR-G01 Black
TR-G03 White

Specification Tip

- **For use with 120 volt 60 hertz electrical system.**

Lighting — Haworth Collection

LIM

	Base/Mount	Number	Price
Freestanding Lighting	Table Light with Block	LLL1-0022-19FLC	\$500.00
	Table Light with Pivot	LLL2-0022-19FLC	500.00
	Floor Light	LLL3-0022-19FLC	475.00

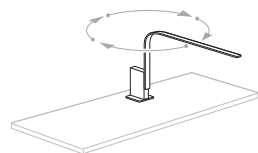

Table Light with Block
LLL1

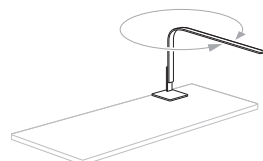

Table Light with Pivot
LLL2



Floor Light
LLL3



Features

- Includes base/mount, 22”(559mm) arm with LED light with a clear lens, nine foot removable silvertone cord, and one wire management clip.
- Features two-stage light control with 3.0 watt and 7.3 watt selection.
- All lights use magnets to attach to base or brackets.
- **Table Light with Block:**
 - Available in Textured White, Textured Black and Brushed Aluminum.
 - Arm rotates around magnetic connection between base and light arm.
 - Adjustable height fixture range is 12”-15.75”(305mm-400mm) from desktop.
 - Base includes scratch-resistant bottom with cord management.
 - Base size: 6.63”(168mm) height, 3”(76mm) width, 3.5”(89mm) depth.
- **Table Light with Pivot:**
 - Available in Textured White and Textured Black.
 - Pivot rotates 360° around the base.
 - Arm rotates around magnetic connection between base and light arm.
 - Pivot light does not have adjustable height.
 - Base includes scratch-resistant bottom.
 - Base size: 5”(127mm) height, 4.5”(114mm) width, 5.5”(140mm) depth.
- **Floor Light:**
 - Available in Textured White and Textured Black.
 - Arm rotates around magnetic connection between base and light arm.
 - Adjustable height fixture range is 13”-50.75”(330mm-1289mm) from floor.
 - Base includes scratch-resistant bottom.
 - Base size: 38”(965mm) height, 9”(229mm) width, 9”(229mm) depth.

To Order, Specify:

- 1) Product number.
- 2) Trim color:
 - Pivot/Floor available in:
 - TR-L2 Textured White
 - TR-L3 Textured Black
 - Block available in:
 - TR-L2 Textured White
 - TR-L3 Textured Black
 - TR-L1 Brushed Aluminum

Specification Tips

- For use with 120 volt 60 hertz electrical system.
- Minor assembly required.

Lighting — Haworth Collection

LIM

	Base/Mount	Average Height	Number	Price
Worksurface Mounted Lighting	Worksurface Mounted Light	18.5"(470mm)	LLC1-0022-19WLC	\$325.00

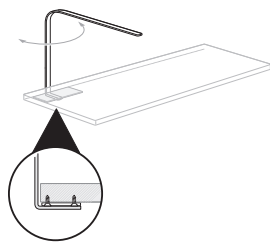

Worksurface Mount
LLC1



Features

- Includes base/mount, 22"(559mm) arm with LED light with a clear lens, nine foot removable silvertone cord, and one wire management clip.
- Under Shelf attachment bracket painted to compliment the LED light.
- Features two-stage light control with 3.0 watt and 7.3 watt selection.
- All lights use magnets to attach to base or brackets.
- **Worksurface Mount:**
 - Available in **Brushed Aluminum, Textured White, Textured Black.**
 - Arm rotates at Under Worksurface attachment bracket.
 - Light does not have adjustable height.
 - Flat Bracket is scratch-resistant.
 - Mount includes a 11"(279mm) flat bracket with adhesive.

To Order, Specify:

- 1) Product number.
- 2) Trim color:
 - TR-L2 Textured White
 - TR-L3 Textured Black
 - TR-L1 Brushed Aluminum

Specification Tips

- **For use with 120 volt 60 hertz electrical system.**
- Minor assembly required.

Lighting — Haworth Collection

LIM

	Base/Mount	Panel System	Number	Price
Mounted Lighting	Slat/Rail		LLM1-0023-19MLC	\$315.00
	Panel	for Compose	LLM2-0023-19MLCZ	\$315.00
		for UniGroup Too	LLM2-0023-19MLCE	315.00
	Under Shelf Proud		LLU2-0023-19ULC	\$315.00

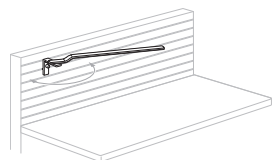

Slat LLM1

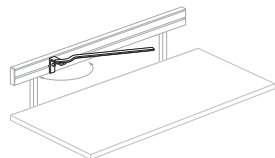

Belong Rail LLM1

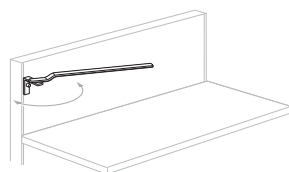

Panel LLM2

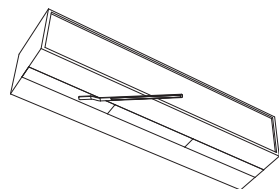

Under Shelf LLU2



Features

- Includes base/mount, 23.25”(591mm) arm with LED light with a clear lens, nine foot removable silvertone cord, and one wire management clip.
- Features two-stage light control with 3.0 watt and 7.3 watt selection.
- Overall height ranges dependent on the mount.
- All lights use magnets to attach to base or brackets.
- **Slat:**
 - Available in Textured White and Textured Black.
 - Rotates 180 degrees horizontally around the mount.
 - Slat Mount can be adjusted within the slat profiles – hooks into the second bottom slat and can be adjusted to the top slat off the slat tiles.
 - Mount is scratch-resistant.
 - Can be used on any Haworth slat tile.
 - Slat Tile Bracket size: 3”(76mm) height, 1”(25mm) width, 3”(76mm) depth.
- **Panel:**
 - Available in Textured White and Textured Black.
 - Rotates 180 degrees horizontally around the mount.
 - Panel Mount can be adjusted within the panel slot profiles.
 - Mount is scratch-resistant.
 - Can be used on any Haworth Panel System.
 - Panel Mount Bracket size: 3”(76mm) height, 1”(25mm) width, 3”(76mm) depth.
- **Under Shelf Proud:**
 - Available in Brushed Aluminum, Textured White, Textured Black.
 - Arm rotates at Under Shelf attachment bracket.
 - Slat Mount can be adjusted within the slat tile profiles.
 - Flat Bracket is scratch-resistant.
 - Can be used on: Adaptable Upper Storage.
- Under Shelf attachment bracket painted to complement the LED light.

To Order, Specify:

- 1) Product number.
- 2) Trim color:
 - Slat/Panel mount available in:
 - TR-L2 Textured White
 - TR-L3 Textured Black
 - Under Shelf mount available in:
 - TR-L2 Textured White
 - TR-L3 Textured Black
 - TR-L1 Brushed Aluminum

Specification Tips

- For use with 120 volt 60 hertz electrical system.
- Minor assembly required.

Lighting — Haworth Collection

LIM

	Base/Mount	Panel System	Units	Number	Price
LIM Hardware	Slat Mount Bracket		1	LLH1-0000	\$ 50.00
	Panel Mount Bracket	for Compose	1	LLH2-0000-Z	\$ 50.00
		for UniGroup Too	1	LLH2-0000-E	50.00
	Under Shelf Flat/Under Shelf Proud/Worksurface Bracket*		5	LLH3-0000	\$120.00
	Wire Management Clips		10	LLH6-0000	\$ 56.16

Features

- Hardware for use with LIM lights to provide additional attachment.
- Each bracket description correlates with the appropriate LIM light. Please specify accordingly.
- For use if greater user adjustment is required.
- Wire management clips are standard in White.



***Same brackets are used for Under Shelf Proud and Worksurface Mount LIM light applications.**



To Order, Specify:

- 1) Product number.
- 2) Trim color for brackets:
 TR-L2 Textured White
 TR-L3 Textured Black

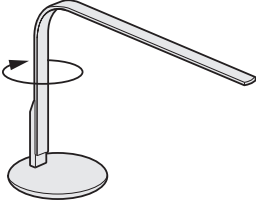
Lighting — Haworth Collection

LIM360

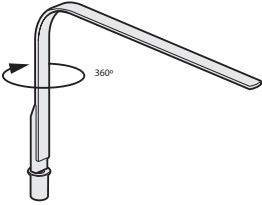
		Number	Price
Table Light  LL31-2210-NFLC 	Grade A	LL31-2210-NFLC	\$395.00
	Grade B	LL31-2210-NFLC	\$395.00
Features <ul style="list-style-type: none"> • Includes base, aluminum arm with USB charging port, LED lights, clear lens, full range dim control and 10' removable cord. • Base is scratch resistant aluminum ring with wood or plastic magnetic base insert. • Base is 6.5" (165mm) diameter. • Arm is 13.5" (343mm) high x 21.5" (546mm) wide and 1" (25mm) deep. • Features a LED light source with full range dim control and 360° swivel adjustment. • 7 watts. 		To Order, Specify: <ol style="list-style-type: none"> 1) Product number. 2) Trim color. <ul style="list-style-type: none"> Grade A <ul style="list-style-type: none"> TR-L8 White Arm, Silver Base TR-L13 Black Arm, Black Base Grade B <ul style="list-style-type: none"> TR-L10 Aluminum Arm, Silver Base TR-L11 Aluminum Arm, Walnut Base TR-L14 Black Arm, Walnut Base TR-L9 White Arm, Walnut Base 	
Specification Tips <ul style="list-style-type: none"> • For use with 120 volt 60 hertz electrical system. • Minor assembly required. 			

Grommet Mounted Light  LL32-2210-NGLC 	Grade A	LL32-2210-NGLC	\$385.00
	Grade B	LL32-2210-NGLC	\$385.00
Features <ul style="list-style-type: none"> • Includes base, aluminum arm with USB charging port, LED lights, clear lens, full range dim control and 10' removable cord. • Surface mount grommet is 2" (51mm) high and 1" (25mm) wide and finished in satin aluminum. • Arm is 13" (330mm) high x 20" (508mm) wide and 1" (25mm) deep. • Features a LED light source with full range dim control and 360° swivel adjustment. • 7 watts. 		To Order, Specify: <ol style="list-style-type: none"> 1) Product number. 2) Trim color. <ul style="list-style-type: none"> Grade A <ul style="list-style-type: none"> TR-L4 White TR-L6 Black Grade B <ul style="list-style-type: none"> TR-L5 Aluminum 	
Specification Tips <ul style="list-style-type: none"> • For use with 120 volt 60 hertz electrical system. • Minor assembly required. 			

Lighting — Haworth Collection

Pixo

Table Light

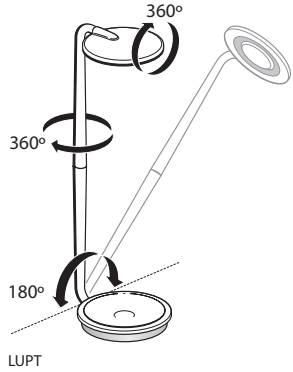

Features

- Includes base/mount with USB charging port, 16.5"(419mm) arm with LED light and 6'(182cm) attached cord.
- Available with optional integrated occupancy sensor.
- Available in supplier silver, white or black.
- Hi-low dim control.
- 360° arm rotation.
- 180° arm tilt.
- 360° shade rotation.
- USB port for charging cell phones.
- Advanced LED array eliminates multiple shadows.
- Power consumption: 6W.
- Color temperature: 3000K.
- Luminosity: 285 Lumens.
- Color Rendition Index: 90 CRI.
- 50K hour lifespan.
- Cord length: 6'(182cm).

Specification Tips

- Minor assembly required.
- **For use with 120 volt 60 hertz electrical system.**

Number	①	Trim A	B
LUPT-0016-05FL		\$275.00	\$275.00

To Order, Specify:

1) Product number.

① Occupancy Sensor:

- C No Occupancy Sensor
- O Occupancy Sensor, add \$40.00 list

2) Trim color.

Table Light

- TR-11 Black
- TR-12 Silver
- TR-13 White

Table Light with Occupancy Sensor Standard Trim

- TR-11 Black
- TR-12 Silver
- TR-13 White

Lighting — Haworth Collection

Superlight

	Height	Depth	Width	Number	Price
Table Light	25.75"(645mm)	8"(203mm)	23.5"(597mm)	HCPL-SLT1-17	\$350.00

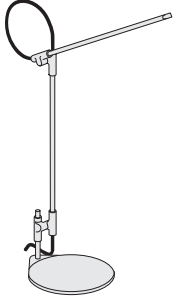

HCPL-SLT1-17



Features

- Includes one aluminum body with polycarbonate lens, steel base 9' cord and magnetic base pad.
- Ultra light, minimal frame.
- LED array with full range dim control.
- Lens rotates 90°.
- Joints have three axis rotation.
- Six hour energy saving auto-off timer.
- 8.6 watts.

Specification Tips

- **For use with 120 volt 60 hertz electrical system.**
- Minor assembly required.

To Order, Specify:

- 1) Product number.
- 2) Trim color.
TR-S10 Black
TR-S11 White
- 3) Base Pad
TR-S15 Charcoal
TR-S16 Chestnut
TR-S18 Mustard
TR-S17 Turquoise

	Height	Depth	Width	Number	Price
Floor Light	57.5"(1460mm)	8"(203mm)	23.5"(597mm)	HCPL-SLF1-47	\$425.00

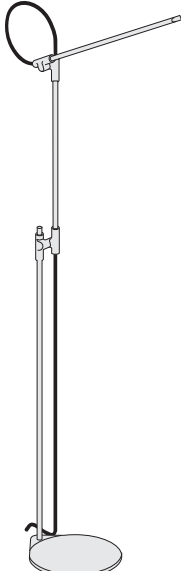

HCPL-SLF1-47



Features

- Includes one aluminum body with polycarbonate lens, steel base 9' cord and magnetic base pad.
- Slim ultra light, minimal frame.
- LED light with full range dim control.
- Lens rotates 90°.
- Joints have three axis rotation.
- Six hour energy saving auto-off timer.
- 8.6 watts.

Specification Tips

- **For use with 120 volt 60 hertz electrical system.**
- Minor assembly required.

To Order, Specify:

- 1) Product number.
- 2) Trim color.
TR-S10 Black
TR-S11 White
- 3) Base Pad
TR-S15 Charcoal
TR-S16 Chestnut
TR-S18 Mustard
TR-S17 Turquoise

	Diameter	Number	Price
Base Pads	8"(203mm)	HCPL-SLSV-4BP	\$64.00

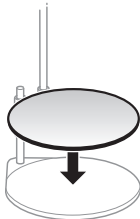

HCPL-SLSV-4BP

Feature

- Includes set of four felt base pads, one each of four colors.

To Order, Specify:

- 1) Product number.

Lighting — Haworth Collection

Tube Top

	Description	Height	Depth	Width	Number	Price
Table Light	Small	14"(356mm)	4.5"(114mm)	9.5"(241mm)	HCPL-TTT1-14	\$195.00
	Medium	21"(533mm)	6.5"(165mm)	15"(381mm)	HCPL-TTT2-21	425.00

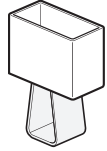

HCPL-TTT1-14

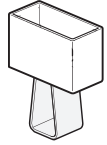

HCPL-TTT2-21



Features

- Includes one polyester mesh shade, acrylic body and 6' fabric cord.
- Fully dimmable LED light controlled by in-line rotary dimmer.
- 6 watts (small table light)
- 13 watts (medium table light)

Specification Tip

- **For use with 120 volt 60 hertz electrical system.**

To Order, Specify:

- 1) Product number.
- 2) Trim color.
 - TR-T40 Charcoal Shade, Charcoal Body
 - TR-T41 Silver Shade, Clear Body
 - TR-T42 White Shade, Charcoal Body
 - TR-T43 White Shade, Clear Body

Additional colors for Small Table Light only:

- TR-T44 White Shade, Green Body
- TR-T45 White Shade, Cobalt Body
- TR-T46 White Shade, Hot Pink Body
- TR-T47 White Shade, Ruby Red Body
- TR-T48 White Shade, Sky Blue Body
- TR-T49 White Shade, Yellow Body

	60"(1524mm)	9"(229mm)	18"(457mm)	HCPL-TTF1-60	\$1095.00
Floor Light					

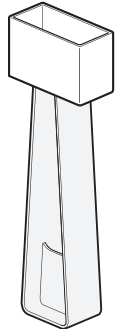

HCPL-TTF1-60



Features

- Includes one polyester mesh shade, acrylic body and 6' fabric cord.
- Fully dimmable LED light controlled by in-line rotary dimmer.
- 13 watts.

Specification Tip



- **For use with 120 volt 60 hertz electrical system.**

To Order, Specify:

- 1) Product number.
- 2) Trim color.
 - TR-T40 Charcoal Shade, Charcoal Body
 - TR-T41 Silver Shade, Clear Body
 - TR-T42 White Shade, Charcoal Body
 - TR-T43 White Shade, Clear Body

Lighting — Haworth Collection

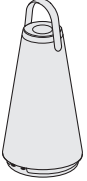
UMA

	Number	Price
<p>Audio Lantern</p>  <p>HCPL-UMT2-11</p> 	<p>HCPL-UMT2-11</p> <p>Features</p> <ul style="list-style-type: none"> • Includes one battery powered light with polycarbonate lens, steel grille and silicone feet, two interchangeable leather handles (one grey and one tan) and storage bag. • Portable and rechargeable. <ul style="list-style-type: none"> –Battery Life - 8 hours –Charging time - up to 3.5 hours • Bluetooth connectivity provides 360° sound with touch sensitive volume control. • Intuitive full range light control dial adjusts warm dim LED technology. • Storage bag is cotton with a leather drawstring. • Light is 6”(152mm) in diameter at the base and 11”(279mm) high (leather handle adds 2.25”(57mm) to height.) • 4.2 watts (light), 12 watts (speakers). <p>Specification Tip</p> <ul style="list-style-type: none"> • For use with 120 volt 60 hertz electrical system. 	<p>To Order, Specify:</p> <p>1) Product number.</p>

Recycling Solutions

Height	Depth	Width	Number	Painted A	B
39.5"(1003mm)	18.75"(476mm)	48"(1219mm)	JRPY-3948-SJAN	\$6048.46	\$6380.93

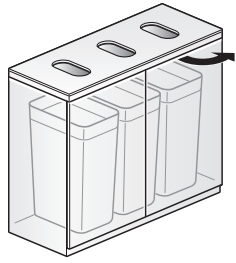

JRPY-3948
Class FM – SIN 33721,
Discount Group XII

Features

- Includes:
 - Painted steel cabinet and top with three 11"(279mm) x 6"(152mm) openings.
 - Non-locking hinged doors
 - Clear acrylic overlay for top
 - 3 removable Rubbermaid recycle bins
- Acrylic top has specific cleaning requirements. Please follow cleaning guidelines found in Haworth's Care and Maintenance Standards.

To Order, Specify:

- Product number.
- Trim color.

Recycling/Trash Bin

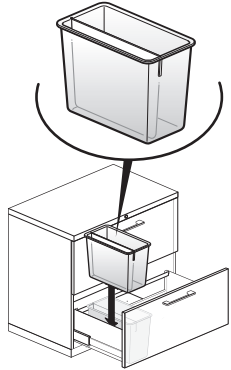

KURB
Class YA – SIN 33721,
Discount Group XIII

Nominal Height	Nominal Depth	Nominal Width	Number	Price
9"(229mm)	12.5"(318mm)	6.5"(165mm)	KURB-0912	\$304.73

Features

- Includes one plastic bin with removable plastic divider.
- Can be suspended from hanging rails in X Series, A Series, Compose and Masters Series pedestals and lateral filing drawers.
- Recycling/Trash Bin can be easily removed from carriage or drawer body to dispose of waste contents.
- Not designed to be freestanding.
- Available in Snow only.
- The removable divider subdivides the space into nominal 4.25"(108mm) and 1.5"(38mm) sections.

To Order, Specify:

- Product number.
(No finish specification required.)

Specification Tip

- Cannot accommodate hanging files.

Storage

Belong

Nominal Height	Nominal Depth	Nominal Width	Number	Trim A	B
Box/File					
16"(406mm)	17"(432mm)	9"(229mm)	KUPA-1609-SNSUNN	\$984.90	\$1012.65
Box Drawer/Open					
16"(406mm)	17"(432mm)	9"(229mm)	KUPD-1609-SNSUNN	\$733.95	\$ 770.70

Suspended Pedestal

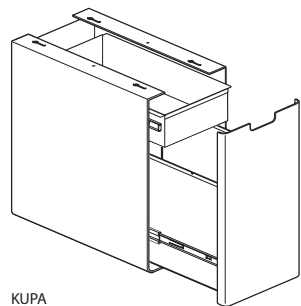

KUPA

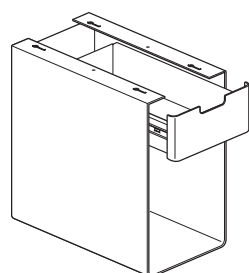

KUPD

Feature

- Includes painted steel box/file pedestal or open pedestal with box drawer and attachment hardware.

Specification Tips

- Separately specified accessories, if applicable:
 - Drawer Liner
 - Drawer Tray
 - Magnetic Divider
 - File Partition
- For use on height adjustable configurations 29"(737mm)D or greater.
 - Upside C-Leg; single stage (standard range) and dual stage (extended range) models.
 - Planes LT C-Leg; single stage ONLY
 - Planes HAT C-Leg; single stage ONLY
- Also for use on:
 - Intuity
 - Panel-mounted Adaptable Worksurfaces
- Pedestal must be mounted inside of the frame end bracket on all height adjustable tables.

To Order, Specify:

- Product number.
- Trim color.

Product	Worksurface			Base	Glides/Casters	Table Height Range	Belong Suspended Storage Max Load	Additional load restrictions (even distribution)	
	Shape	Depth	Width						
Upside	Rectangle	29"	≥58"	C-Leg	Glides	Single Stage (Standard)	70 lbs. (including weight of ped)	150 lbs. (including worksurface)	
					Casters	Single Stage (Standard)	70 lbs. (including weight of ped)	150 lbs. (including worksurface)	
			Glides		Dual Stage (Extended)	50 lbs. (including weight of ped)	100 lbs. (including worksurface)		
			Casters		Dual Stage (Extended)	50 lbs. (including weight of ped)	100 lbs. (including worksurface)		
	Corner	>58"	Glides		Single Stage (Standard)	70 lbs. (including weight of ped)	250 lbs. (including worksurface)		
			Glides		Dual Stage (Extended)	70 lbs. (including weight of ped)	250 lbs. (including worksurface)		
Planes	Rectangle	29"	≥58"	C-Leg	Glides	Single Stage (Standard)	70 lbs. (including weight of ped)	150 lbs. (including worksurface)	
					Caster	Single Stage (Standard)	70 lbs. (including weight of ped)	150 lbs. (including worksurface)	
	Corner		>58"		Glides	Single Stage (Standard)	50 lbs. (including weight of ped)	250 lbs. (including worksurface)	
					Glides	Single Stage (Standard)	50 lbs. (including weight of ped)	250 lbs. (including worksurface)	
Planes LT	Rectangle	29"	≥58"		C-Leg	Glides	Single Stage (Standard)	50 lbs. (including weight of ped)	100 lbs. (including worksurface)
						Caster	Single Stage (Standard)	50 lbs. (including weight of ped)	100 lbs. (including worksurface)
			Corner	>58"		Glides	Single Stage (Standard)	50 lbs. (including weight of ped)	200 lbs. (including worksurface)

Storage Accessories

Belong

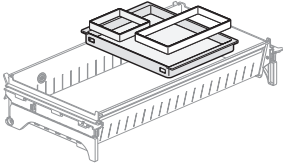
		Number	Price
 <p>KJTY-12 GSA: SIN 33721; Discount Group XIII</p>	<p>Features</p> <ul style="list-style-type: none"> Includes one rectangular PDA tray, one small ring, and one large ring. PDA Tray: <ul style="list-style-type: none"> –Outside dimensions - 1.38”(35mm)H x 11.75”(298mm)W x 16.12”(409mm)L –Inside dimensions - 1.25”(32mm)H x 11.5”(292mm)W x 12.87”(327mm)L Small ring: <ul style="list-style-type: none"> –Outside dimensions - 1”(25mm)H x 5.55”(141mm)W x 5.55”(141mm)L Large ring: <ul style="list-style-type: none"> –Outside dimensions - 1”(25mm)H x 5.98”(152mm)W x 11.43”(290mm)L PDA Tray has cutouts to allow for low voltage cable management. PDA Tray and rings are plastic. Standard in Snow trim. 	KJTY-12	\$54.27
	<p>To Order, Specify:</p> <p>1) Product number. (No finish specification required.)</p>		
	<p>Specification Tips</p> <ul style="list-style-type: none"> PDA Tray designed to be used with the Drawer Insert or as a stand alone accessory in X Series, Masters Series and Compose Storage file drawers. Designed to slide side-to-side along the Drawer Insert front and back panels, or hanging bars in file drawers, allowing access to drawer contents below the PDA Tray. Files cannot be hung in lateral file drawers when using the PDA Tray. <p>Note: Snow (TR-FM) plastic trim color is not recommended for use with painted trim colors Plaster (TR-TW) or Chalk (TR-AK). Refer to Very® Seating chainset for Snow.</p>		

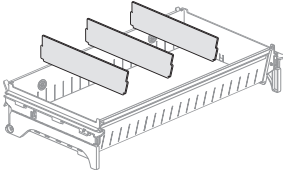
	Height	Depth	Number	Price
 <p>KDV GSA: Open Market</p>	3.4”(86mm)	14.97”(390mm)	KDV-0000	\$49.86
	<p>Features</p> <ul style="list-style-type: none"> Includes set of three plastic dividers. Designed to be used with the Drawer Insert. Standard in Snow trim. <p>Note: Snow (TR-FM) plastic trim color is not recommended for use with painted trim colors Plaster (TR-TW) or Chalk (TR-AK). Refer to Very® Seating chainset for Snow.</p>	<p>To Order, Specify:</p> <p>1) Product number. (No finish specification required.)</p>		

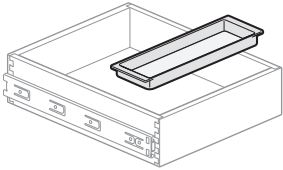
	Height	Depth	Width	Number	Price
 <p>KJTY-10 GSA: Open Market</p>	1.38”(35mm)	5.88”(149mm)	12.87”(327mm)	KJTY-10	\$46.21
	<p>Features</p> <ul style="list-style-type: none"> Includes one rectangle plastic tray. <ul style="list-style-type: none"> –Outside dimensions: 1.38”(35mm)H x 5.88”(149mm)W x 12.87”(327mm)L –Inside dimensions: 1.25”(32mm)H x 5.63”(143mm)W x 11.5”(292mm)L Can be hung between the separately specified dividers of the Drawer Insert. Can be used as a freestanding accessory in X Series lateral files, X Series Pedestal, Masters Series Pedestal and Compose Storage Pedestal. Standard in Snow trim. <p>Note: Snow (TR-FM) plastic trim color is not recommended for use with painted trim colors Plaster (TR-TW) or Chalk (TR-AK). Refer to Very® Seating chainset for Snow.</p>	<p>To Order, Specify:</p> <p>1) Product number. (No finish specification required.)</p>			

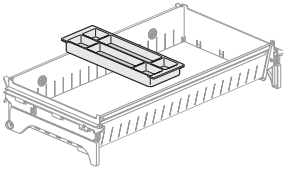
	Height	Depth	Width	Number	Price
 <p>KJTY-9 GSA: SIN 33721; Discount Group XIII</p>	1.25”(32mm)	5.5”(140mm)	16.3”(414mm)	KJTY-9	\$61.54
	<p>Features</p> <ul style="list-style-type: none"> Includes one plastic tray. Suspends from sides of the Drawer Insert; X Series hanging bars; Masters Series 6”(152mm) drawer. Standard in Snow trim. 	<p>To Order, Specify:</p> <p>1) Product number. (No finish specification required.)</p>			
	<p>Specification Tip</p> <ul style="list-style-type: none"> Files cannot be hung in X Series lateral file drawers when using the Pencil tray. 				

Storage Accessories

Belong

	Nominal Height	Nominal Width	Weight	Number ^①	Trim A	B
Security Drawer	5"(127mm) Track	17"(432mm)	12"(305mm)	AHDD-0312-SU NL	\$797.03	\$826.70

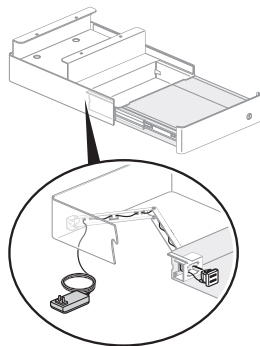

AHDD-SU

Features

- Includes a painted steel drawer and front with lock.
- Available with optional USB power (Retrofit USB Charging Cable EUDX-U000-).
- For lock options, refer to Lock Program section of the Accessories Price List.
- Drawer is 3"(76mm)H.
- Bracket designed to clear desking understructure.

Specification Tips

- Built-in top shelf 2"(51mm) from bottom of worksurface.
- Designed to be used on:
 - Planes and Planes LT Benching configurations 29"(737mm)D or greater.
 - Freestanding Height Adjustable Tables 29"(737mm)D or greater:
 - Upside C-Leg
 - Planes and Planes LT C-Leg
 - Intuity Benching
 - Adaptable Worksurfaces
- Security Drawer without power option cannot be retrofit with power option.

To Order, Specify:

- 1) Product number, including:

① Power Option:

- N** Non-Powered
- U** USB Power (add \$111.20 list)

- 2) Case trim color.
- 3) Front trim color.
- 4) Lock trim color.

Notes: For mixed grade surfaces, please refer to the design and specification tools.

	Depth	Width	Number	Trim A	B
Top Liner — Security Drawer	8"(203mm)	12"(305mm)	ALTD-0812-S	\$101.14	\$105.77

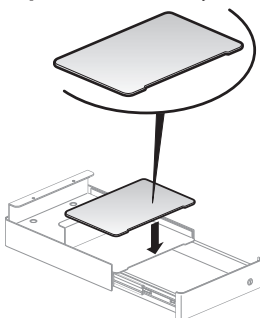

ALTD-S

Features

- Includes one steel liner and double sided tape.

Specification Tips

- Painted steel liner sits on top of built-in top shelf.
- Painted steel liner is not for drawer body.

To Order, Specify:

- 1) Product number.
- 2) Trim color.

	Application	Height	Width	Number	Price
Drawer Liner	Security Drawer	17"(432mm)	12"(305mm)	ALDD-1712-F	\$42.18
	Tray	17"(432mm)	7"(178mm)	ALDT-0607-F	22.25

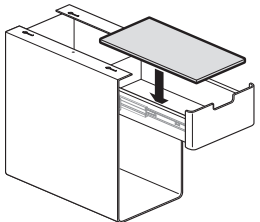

ALDD-F

Feature

- Includes one felt liner.

Specification Tips

- Designed to be used with:
 - Belong pedestal
 - Security Drawer
 - Drawer Tray

To Order, Specify:

- 1) Product number.
- 2) Trim color.

		9"(229mm)	2"(51mm)	AAOC-0302-S	Trim A	B
Personal Storage Hook					\$71.28	\$73.14

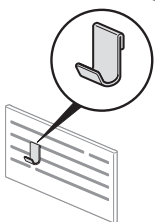

AAOO-S

Feature

- Includes one hook.

Specification Tips

- Can be used with:
 - Security Drawer
 - Belong system Tile (KZBT); must follow load guidelines for weight and size.
- Not for use with Compose Slat Tile.
- Load restrictions vary based on work tool application.

To Order, Specify:

- 1) Product number.
- 2) Trim color.

Storage Accessories

Belong

	Application	Height	Width	Number	Trim A	B
File Partition		10"(254mm)	6"(152mm)	AAOP-1007-S	\$61.07	\$64.75

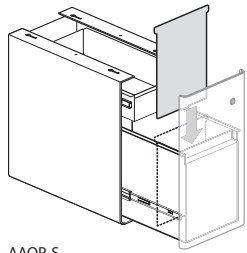

AAOP-S

Features

- Includes one painted steel partition.
- Attaches in file drawer of suspended pedestal for letter filing.

To Order, Specify:

- 1) Product number.
- 2) Trim color.

Drawer Tray		2"(51mm)	7"(178mm)	AAOT-0207-S	\$218.45	\$220.31
--------------------	--	----------	-----------	-------------	----------	----------

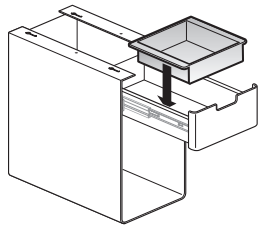

AAOT-S

Feature

- Includes one painted steel tray.

Specification Tips

- Separately specified if applicable:
 - Drawer Liner
 - Magnetic Divider
- Can be used with Belong Suspended Pedestal.

To Order, Specify:

- 1) Product number.
- 2) Trim color.

Magnetic Divider	Drawer Tray	1"(25mm)	7"(178mm)	AAOD-0107-S	\$42.68	\$46.87
	Security Drawer		12"(305mm)	AAOD-0112-S	51.98	58.52

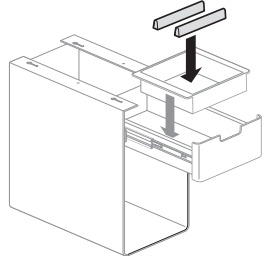

AAOD-S

Feature

- Includes one magnetic aluminum divider.

Specification Tips

- Designed to be used with:
 - Security Drawer
 - Drawer Tray

To Order, Specify:

- 1) Product number.
- 2) Trim color.

Storage Accessories

Belong

Cushion Top

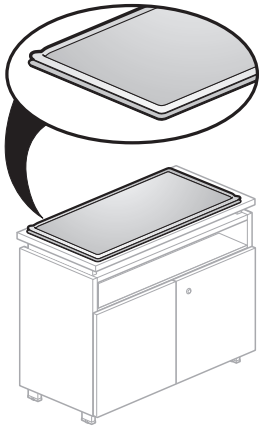

QBFC_F

Depth	Nominal Width	Actual Width	Number	Fabric Grade					
				A	B	C	D	E	F
16.8"(427mm)	24"(610mm)	22.65"(575mm)	QBFC-1824-F	\$657.49	\$ 756.10	\$ 867.88	\$ 986.23	\$1104.59	\$1268.94
	30"(762mm)	28.65"(728mm)	QBFC-1830-F	759.97	874.06	1003.12	1139.89	1276.79	1466.64
	36"(914mm)	34.65"(880mm)	QBFC-1836-F	862.45	992.02	1138.36	1293.55	1448.99	1664.34
	42"(1067mm)	40.65"(1033mm)	QBFC-1842-F	964.93	1109.98	1273.60	1447.21	1621.19	1862.04

Features

- Includes one cushion and non-slip material.
- .75"(19mm) thick cushion is cover stitched around perimeter edges.
- Cushion is inset 0.6"(15mm) from base unit perimeter edges.
- Cushion has a two-sided reversible surface; same fabric on both sides.

To Order, Specify:

- 1) Product number.
- 2) Fabric and color.

Specification Tips

- Cushion is not structural; to be used with a storage top.
- Cushion may be the same width or not as wide as the base unit.
- Patterned fabrics may not align on both sides of the cushion.
- Not for use on 16" D storage.

Wire Management

	Height	Width	Actual Length	Installed Length	Number	Price
Cable Chain	0.75"(19mm)	2.25"(58mm)	40"(1016mm)	36"(914mm)	EAAW-0000-H	\$318.20

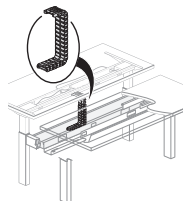

EAAW-0000-H
Class YA – SIN 33721,
Discount Group XIII

Features

- Includes 36"(914mm) active length cable chain and mounting hardware.
- Color black only.
- Mounts to cable trough and underside of worksurface to contain power cords/data cables that are routed from the cable tray to the worksurface.

To Order, Specify:

- 1) Product number.
(No finish specification required.)

Specification Tip

- Holds up to three power cords and two data cables.

Compose Connections Cable Chain	0.75"(19mm)	2.25"(58mm)	40"(1016mm)	36"(914mm)	EUAW-4000-V	\$407.19
--	-------------	-------------	-------------	------------	-------------	-----------------

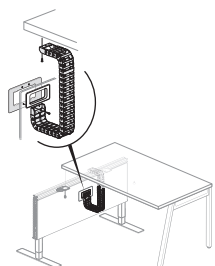

EUAW-4000-V
Class YA – SIN 33721,
Discount Group XIII

Features

- Includes grommet, grommet backer plate, cable chain, bracket to mount to adjacent table and mounting hardware.
- Color black only.
- Mounts to tile and underside of adjacent worksurface to contain power cords and data cables that are routed from inside Compose Connections panel to an adjacent work surface.

To Order, Specify:

- 1) Product number.
(No finish specification required.)

Specification Tip

- Holds up to three power cords and two data cables.

Wire Management

	Length	Height	Width	Description	Number	Price
J-Channel	72"(1829mm)	4.25"(108mm)	2.75"(70mm)	Straight table	4TJC-72	\$288.20

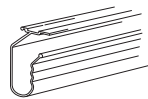

4TJC-72
Class TA – SIN 33721;
Discount Group X

Features

- Includes J-Channel and mounting hardware.
- Field-installed.
- Provides wire management below table tops.
- Attaches to the underside of the table top with screws.
- J-channel to be field cut to length.
- Available in black finish color only.

To Order, Specify:

- 1) Product number.
(No finish specification required.)

					EUAM-0000	\$93.59
Conduit Clamp						

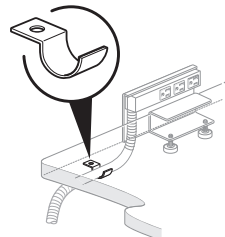

EUAM-0000
Class YA – SIN 33721
Discount Group XIII

Features

- Includes 25 clamps and 25 screws.
- For managing Power Tap cord or conduit under horizontal surfaces.

To Order, Specify:

- 1) Product number.
(No finish specification required.)

	Width	Installed Height		Number	Price
Wire Management Loop	2.75"(70mm)	3.25"(83mm)		NEH-8	\$64.61

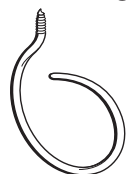

NEH-8
Class YA – SIN 33721;
Discount Group XIII

Features

- Includes box of eight wire management loops.
- Manages and stores wires or cables through loops attached to horizontal surface.
- Threaded top allows installation anywhere under horizontal surfaces in recommended 18"(457mm) intervals.
- Wire management loop is 2"(51mm) in diameter with 3.1 sq. in.(2000mm²) of cross section area.
- Standard in charcoal trim color only.

To Order, Specify:

- 1) Product number.
(No finish specification required.)

			Number	Price
Wire Manager Clips			TA01-0225	\$31.30

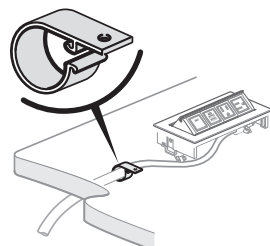

TA01-0225
Class TA – SIN 33721;
Discount Group X

Features

- Includes ten wire manager clips and screws.
- Standard in black plastic.
- Field installed.

To Order, Specify:

- 1) Product number.
(No finish specification required.)

Specification Tip

- Specify for cord management as needed.

Wire Management

	Length	Clips	Number	Price
Wire Manager — Horizontal	48"(1219mm)	2	EUAW-0048-NH	\$215.77
	72"(1829mm)	3	EUAW-0072-NH	323.64
	96"(2438mm)	3	EUAW-0096-NH	431.51
	120"(3048mm)	4	EUAW-00C0-NH	539.21

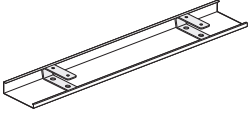

EUAW-NH
Class PT – SIN 33721;
Discount Group IX

Features

- Includes one wire manager and attachment clips.
- Standard in light platinum.
- Field installed.

To Order, Specify:

1) Product number.
(No finish specification required.)

Specification Tip

- Manages and stores wire and cables under horizontal surfaces.

	Length	Depth	Number	Price
Horizontal Wire Management	15"(381mm)	2"(51mm)	WUAW-1500-PNH	\$254.80

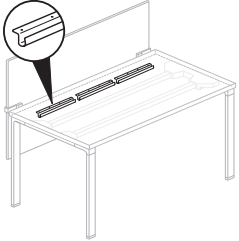

WUAW-PNH
Class CA – SIN 33721;
Discount Group I

Features

- Includes ten plastic wire managers and attachment hardware.
- Manages and stores wires or cables under horizontal surface.
- Standard in charcoal trim color only.

To Order, Specify:

1) Product number.
(No finish specification required.)

	Height	Depth	Width	Number	Price
Vertical Cable Guide	0.75"(19mm)	0.5"(13mm)	3"(76mm)	NECG-V	\$85.38

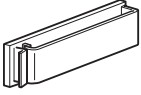

NECG-V
Class BC – SIN 33721
Discount Group I

Features

- Includes package of twelve cable guides.
- Manages communication cables.
- Self-adhesive back attaches to the top or bottom of horizontal surface.
- Standard in gray trim color only.

To Order, Specify:

1) Product number.
(No finish specification required.)

Wire Management

	Depth	Width	Number	Price
Height Adjustable Table - Belong Horizontal	12"(305mm)	30"(762mm)	AKWN-1230-EUN	\$377.69

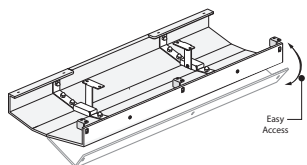

AKWN
Class TR01 – Open Market

Features

- Includes one PET (Polyethylene Terephthalate) cable manager, tray and attachment hardware.
- Available in three colors: Dusk, Flint, and Mink.
- Ships unassembled.

To Order, Specify:

- 1) Product number.
- 2) PET color.
PET-C1 Dusk
PET-C2 Flint
PET-C4 Mink

Specification Tips

- Not for use with Compose Echo table.
- Not designed for use on Flip Top Tables (Planes or Jive).
- Use a low profile monitor arm bracket with the tray.
- Refer to Electrical Components Belong Wire Management Tray General Specifications
- Application may require approval of local authority having jurisdiction (AHJ); ensure compliance before placing orders and installation.

	Width	Number	Price
Wire Management Basket	18"(457mm)	TAWB-0918	\$180.24
	24"(610mm)	TAWB-0924	189.28
	36"(914mm)	TAWB-0936	207.29

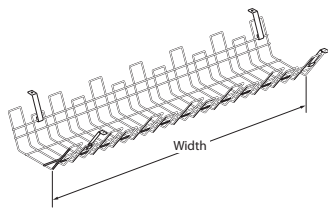

TAWB
Class TA – GSA: Open Market

Features

- Includes one basket, four brackets and attachment hardware.
- Standard in black.
- Basket is 8.5"(203mm) deep x 3.5"(76mm) high. With mounting hardware overall height is 4.94"(102mm) and depth is 10.82"(254mm).
- Accessible from both sides.
- Basket detaches without tools.

To Order, Specify:

- 1) Product number.
(No finish specification required.)

Specification Tips

- Verify mounting clearance with table understructure.
- Separately specify covers.

	Width	Number	Price
Basket Cover	18"(457mm)	TABC-0918	\$ 49.78
	24"(610mm)	TABC-0924	66.83
	36"(914mm)	TABC-0936	\$100.81

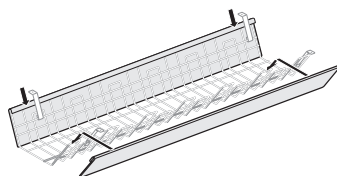

TABC (Two covers shown)
Class TA – GSA: Open Market

Feature

- Includes one painted cover.

To Order, Specify:

- 1) Product number.
- 2) Trim color.

Note: \$15.63 upcharge list for Metallic and Accent trim colors.

Specification Tips

- Designed to be used with wire management basket. Up to two can be installed.
- Order to match wire management basket width.

	For Use With	Height	Width	Number	Trim A	B
Vertical Wire Channel - Leg Attached	28" Frame	25.7"(635mm)	1.17"(25mm)	TYVW-2601-P	\$109.38	\$115.83
	40" Frame	37.7"(940mm)	1.17"(25mm)	TYVW-3801-P	\$115.03	\$124.43

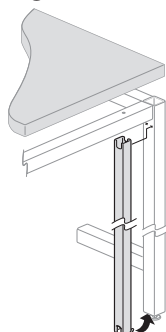

TYVW
Class CL – GSA: Open Market

Feature

- Includes wire manager and attachment screws.

To Order, Specify:

- 1) Product number.
- 2) Trim color.

Specification Tips

- Order correct model for table height.
- Add additional Vertical Wire Channels if cord number exceeds three cords.
- Accommodates 2-3 cords/cables (depending on cable diameter) or one 0.5" Flexible Conduit.

Wire Management

	Length	Number	Price
Planes C-Leg Training Table Vertical Wire Manager	16"(406mm)	TA01-0228-F	\$57.91

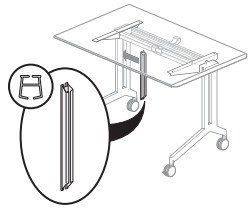

TA01-0228-F
Class TA – SIN 33721;
Discount Group X

Features

- Includes one plastic wire manager.
- Standard in black.
- Field installed.

To Order, Specify:

- 1) Product number.
(No finish specification required.)

Specification Tips

- For use on Planes C-Leg Training Tables for wire management.
- Snaps into top portion of C-leg base.

	Description	Length	Number	Price
Compose Task Light Cord Manager	Wire Manager, Vertical	17"(432mm)	VZAW-0000-V	\$258.50

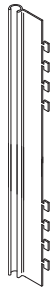

VZAW-0000-V
Class BC – SIN 33721;
Discount Group XI

Features

- Includes package of 10.
- Vertical wire manager conceals task light cord.
- Attaches into Compose panel frame slots.
- Black finish only.

To Order, Specify:

- 1) Product number.
(No finish specification required.)

	Height	Depth	Width	Number	Price
UniGroup Too, UniGroup and PLACES Wire Manager	72"(1829mm)	0.75"(19mm)	0.75"(19mm)	WC-6	\$44.31

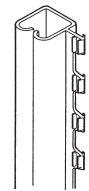

WC-6
Class AA – SIN 33721;
Discount Group I

Features

- Includes field-cuttable channel.
- Guides wires or cables vertically.
- Inserts into the panel side rail reveals.
- Not available for use in the city of Los Angeles.

To Order, Specify:

- 1) Product number.
- 2) Trim color.

Specification Tip

- For use with UniGroup Too, UniGroup and PLACES.

Work Tools — Mounting

Slat, Wall Mount

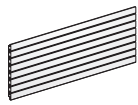

KUPY

Class CA – SIN 33721;
Discount Group I

Nominal Height	Width	Number	Trim	
			A	B
16"(406mm)	18"(457mm)	KUPY-1618	\$411.24	\$418.87
	24"(610mm)	KUPY-1624	445.19	454.71
	30"(762mm)	KUPY-1630	479.14	490.55
	36"(914mm)	KUPY-1636	513.09	526.39
	42"(1067mm)	KUPY-1642	547.04	562.23
	48"(1219mm)	KUPY-1648	580.99	598.07
	54"(1372mm)	KUPY-1654	614.94	633.91
	60"(1524mm)	KUPY-1660	648.89	669.75

Features

- Includes slat tile & attachment brackets for structural wall.
- Belong and Jump Stuff work tools may be used; separately specified.

To Order, Specify:

- 1) Product number.
- 2) Trim color.

Specification Tips

- Designed to be used under wall mounted overhead storage units.
- Allows space for task light cord routing.
- **Not for use with wall track.**

Work Tools — Mounting

Belong

Single Side

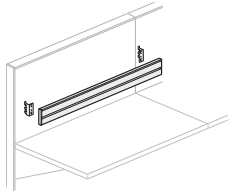

KUR1-0424-PZN

Height	Depth	Width	Number	Trim A	B
Compose					
4"(102mm)	1"(25mm)	24"(610mm)	KUR1-0424-PZN	\$235.53	\$255.54
		30"(762mm)	KUR1-0430-PZN	252.45	274.28
		36"(914mm)	KUR1-0436-PZN	269.37	293.02
		42"(1067mm)	KUR1-0442-PZN	286.29	311.76
		48"(1219mm)	KUR1-0448-PZN	303.21	330.50
		54"(1372mm)	KUR1-0454-PZN	320.13	349.24
		60"(1524mm)	KUR1-0460-PZN	458.99	489.92
UniGroup					
4"(102mm)	1"(25mm)	24"(610mm)	KUR1-0424-PEN	\$235.53	\$255.54
		30"(762mm)	KUR1-0430-PEN	252.45	274.28
		36"(914mm)	KUR1-0436-PEN	269.37	293.02
		42"(1067mm)	KUR1-0442-PEN	286.29	311.76
		48"(1219mm)	KUR1-0448-PEN	303.21	330.50
		54"(1372mm)	KUR1-0454-PEN	320.13	349.24
		60"(1524mm)	KUR1-0460-PEN	458.99	489.92

Features

- Includes one rail with panel attachment brackets.
- Mounts to panel side trim rails/connectors/slotted frame/wall track to support rail tools.
- Tool Rail is 0.625"(16mm) thick; brackets provide 0.375"(10mm) gap for cord management.
- Belong and Jump Stuff work tools may be used; separately specified.

To Order, Specify:

- 1) Product number.
- 2) Trim Color for rail/brackets (product line specific; refer to appropriate price list).

Specification Tips

- **Supports maximum load of 40 pounds of Paper Management evenly distributed.**
- Panel mounted rail may span one or more panels equivalent to rail width.
- Recommended mounting position is approximately 9"(229mm) above worksurface.
- Rail is for use with specific product lines: Compose® and UniGroup Too®.

Work Tools — Mounting

Belong

Tool Rail — Horizontal Surface Mount C-Clamp or Thru-Mount

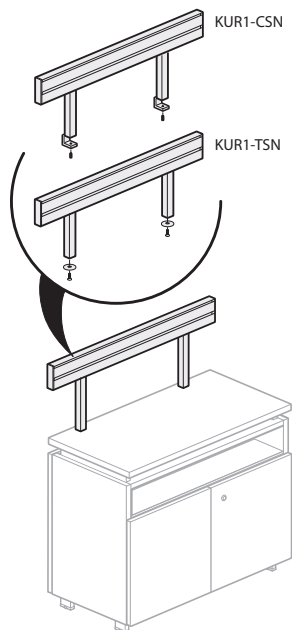

KUR1-1224-CSN

Rail Height	Width	Description	Number	Trim A	B
1.19" (30mm) Thick Top					
4" (102mm)	24" (610mm)	C-Clamp	KUR1-1224-CSN	\$445.87	\$465.88
	30" (762mm)		KUR1-1230-CSN	469.54	491.37
	36" (914mm)		KUR1-1236-CSN	493.21	516.86
	42" (1067mm)		KUR1-1242-CSN	516.88	542.35
	48" (1219mm)		KUR1-1248-CSN	540.55	567.84
	54" (1372mm)		KUR1-1254-CSN	564.22	593.33
	60" (1524mm)		KUR1-1260-CSN	709.83	740.76
2" (51mm) Thick Top					
4" (102mm)	24" (610mm)	C-Clamp	KUR1-1224-CMN	\$445.87	\$465.88
	30" (762mm)		KUR1-1230-CMN	469.54	491.37
	36" (914mm)		KUR1-1236-CMN	493.21	516.86
	42" (1067mm)		KUR1-1242-CMN	516.88	542.35
	48" (1219mm)		KUR1-1248-CMN	540.55	567.84
	54" (1372mm)		KUR1-1254-CMN	564.22	593.33
	60" (1524mm)		KUR1-1260-CMN	709.83	740.76
1.19" (30mm) Thick Top					
4" (102mm)	24" (610mm)	Thru-mount	KUR1-1224-TSN	\$445.87	\$465.88
	30" (762mm)		KUR1-1230-TSN	469.54	491.37
	36" (914mm)		KUR1-1236-TSN	493.21	516.86
	42" (1067mm)		KUR1-1242-TSN	516.88	542.35
	48" (1219mm)		KUR1-1248-TSN	540.55	567.84
	54" (1372mm)		KUR1-1254-TSN	564.22	593.33
	60" (1524mm)		KUR1-1260-TSN	709.83	740.76
2" (51mm) Thick Top					
4" (102mm)	24" (610mm)	Thru-mount	KUR1-1224-TMN	\$445.87	\$465.88
	30" (762mm)		KUR1-1230-TMN	469.54	491.37
	36" (914mm)		KUR1-1236-TMN	493.21	516.86
	42" (1067mm)		KUR1-1242-TMN	516.88	542.35
	48" (1219mm)		KUR1-1248-TMN	540.55	567.84
	54" (1372mm)		KUR1-1254-TMN	564.22	593.33
	60" (1524mm)		KUR1-1260-TMN	709.83	740.76

Features

- Includes one double sided rail with two posts, two rail end caps and attachment hardware.
- Mounts to horizontal surface to support rail tools.
- 1.19" (30mm) C-clamp Rail mounts on horizontal surfaces from 0.75" (19mm) to 1.75" (44mm) thick.
- Thru-mount Rail mounts on 1.19" (30mm) thick horizontal surfaces.
- Posts are 1.25" (32mm) thick.
- Belong and Jump Stuff work tools may be used; separately specified.
- Rail overall height above horizontal surface: 11.81" (300mm).
- Distance between rail bottom and top of horizontal surface: 7.44" (189mm).
- Ships unassembled.

To Order, Specify:

- 1) Product number.
- 2) Trim color for rail/post.
- 3) Trim color for rail end caps:
 - TR-K Charcoal
 - TR-J Graphite
 - TR-FM Snow

Specification Tips

- Designed for single sided benching applications.
- **Not designed to be used in front of panel mounted accessories (tackboard, markerboard).**
- Tool Rail supports a maximum load of 40 pounds evenly distributed on user side.
- If supporting two monitor arms (up to 13 pounds each); an additional C-clamp or thru-mount post is recommended.
- Rail may be installed off modular.
- Heavy load application; additional posts can be ordered.
- Monitor arm cannot be mounted in post positions.
- Thru-mount post can be attached flush to back edge of horizontal surface.
- C-clamp rail can be attached to panel mounted horizontal surface with notch or radius wireways without removing the horizontal surface.
- Under horizontal surface: 4" (102mm) of clearance is necessary between back of horizontal surface and adjacent component for clamp attachment.
- Gap between screen and horizontal surface allows installation of Belong Tool Rail.
- Utility tray provides clearance for installation of Belong Tool Rail.

Note: No more than 6" (152mm) of rail can be extended beyond outside of support.

Work Tools — Mounting

Belong

	Post Height	Description	Number	Trim A	B
Tool Rail — Single Post — C-Clamp or Thru-mount	1.19"(30mm) Thick Top				
	7.5"(191mm)	C-Clamp	KUP1-0000-CSN	\$138.29	\$149.21
	2"(51mm) Thick Top				
	7.5"(191mm)	C-Clamp	KUP1-0000-CMN	\$138.29	\$149.21
	1.19"(30mm) Thick Top				
	7.5"(191mm)	Thru-mount	KUP1-0000-TSN	\$138.29	\$149.21
2"(51mm) Thick Top					
	7.5"(191mm)	Thru-mount	KUP1-0000-TMN	\$138.29	\$149.21

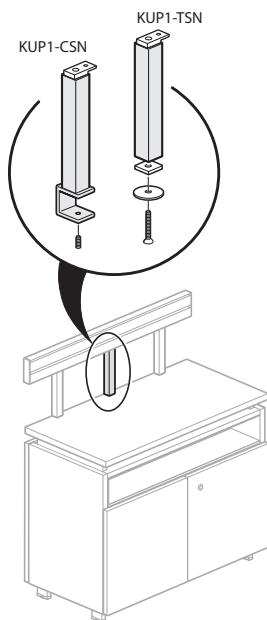

KUP1-0000-CSN

Features

- Includes one C-clamp or one Thru-mount Post and attachment hardware.
- Posts mount on horizontal surfaces 1.19"-2"(30mm-51mm) thick.
- Posts are 1.25"(32mm) thick.

To Order, Specify:

- 1) Product number.
- 2) Trim color.

Specification Tips

- Posts supports slide along rail bottom groove.
- For use with C-clamp or Thru-mount tool rail only.
- Monitor arm cannot be mounted in post position.
- Extra single posts can be ordered when additional support for monitor arms and paper management are attached to Tool Rail.

Work Tools — Mounting

Belong

	Rail Height	Width	Number	Trim A	B
Tool Rail — Under Horizontal Surface Mount — L-Bracket	4"(102mm)	24"(610mm)	KUR1-1224-USN	\$445.87	\$465.88
		30"(762mm)	KUR1-1230-USN	469.54	491.37
		36"(914mm)	KUR1-1236-USN	493.21	516.86
		42"(1067mm)	KUR1-1242-USN	516.88	542.35
		48"(1219mm)	KUR1-1248-USN	540.55	567.84
		54"(1372mm)	KUR1-1254-USN	564.22	593.33
		60"(1524mm)	KUR1-1260-USN	709.83	740.76
		66"(1676mm)	KUR1-1266-USN	749.82	784.39
		72"(1829mm)	KUR1-1272-USN	789.81	824.38
		78"(1981mm)	KUR1-1278-USN	829.80	866.19
		84"(2134mm)	KUR1-1284-USN	869.79	908.00
		90"(2286mm)	KUR1-1290-USN	909.78	949.81
	96"(2438mm)	KUR1-1296-USN	949.77	991.62	

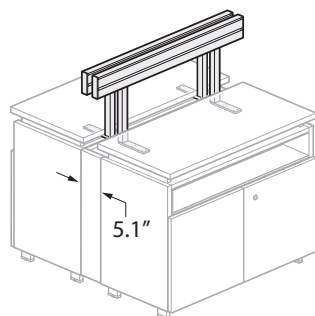
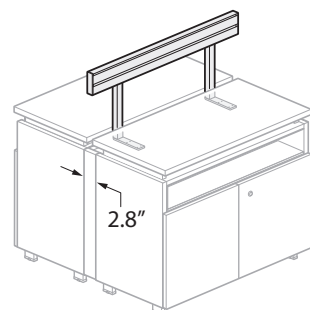
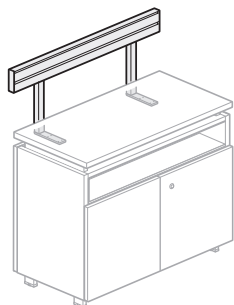

KUR1-1224-USN

Features

- One double sided rail with two or three posts, two rail end caps and attachment brackets.
- Rails 66"-96" (1676mm-2438mm) include three posts.
- L-bracket mounts under 1.19"(30mm) thick horizontal surface to support rail tools on both sides.
- Belong Work Tools or Jump Stuff Slat Pad Tools may be used; separately specified.
- Rail overall height above horizontal surface: 11.18"(284mm).
- Distance between rail bottom and top of horizontal surface: 7.44"(189mm).
- Post is 1.25"(32mm) thick.
- Ships unassembled.

To Order, Specify:

- 1) Product number.
- 2) Trim color for rail/post.
- 3) Trim color for rail end caps:
 - TR-K Charcoal
 - TR-J Graphite
 - TR-FM Snow

Specification Tips

- **Rail with L-bracket or shared bracket mount can only be used in non-panel applications.**
- **Designed for single sided benching applications.**
- **Tool Rail supports a maximum load of 40 pounds (18.14kg) evenly distributed on user side or supports two monitor arms up to 13 pounds each; additional L-bracket mount post recommended.**
- For use with one base unit or back-to-back base units; L-Bracket Tool Rail is double sided to accommodate Belong work tool accessories on both sides.
- For back-to-back base unit applications, one or two L-Bracket tool rail(s) may be used:
 - One L-Bracket tool rail may be used between base units which results in an aesthetically unbalanced tool rail condition. Both users share a single tool rail. L-Brackets are attached to only one of the two back-to-back storage tops. (Note: KUR2-USN Under Worksurface Mount T-Bracket is not recommended for use with back-to-back base units due to installation issues.)
 - Two back-to-back L-Bracket tool rails may be used between base units for an aesthetically balanced tool rail condition.
 - For a single tool rail application, a 2.8"(71mm) deep filler panel may be used to fill gap between back-to-back units.
 - For two back-to-back tool rails, a 5.1"(130mm) deep filler panel may be used to fill gap between back-to-back base units.
- Tool Rail should be specified 6"(152mm) shorter than screen if both are specified.
- Can be installed off modular.
- Under horizontal surface: 4"(102mm) of clearance is necessary between back of horizontal surface and adjacent component for flat bracket attachment.
- Heavy load application; additional posts can be ordered.
- Monitor arm cannot be mounted in post positions.
- Gap between screen and horizontal surface allows installation of Belong Tool Rail.
- Utility tray provides clearance for installation of Belong Tool Rail.
- Posts mount flush to back edge of horizontal surface.

Note: No more than 6"(152mm) of rail can be extended beyond outside of support.

Work Tools — Mounting

Belong

	Post Height	Number	Trim A	B
Tool Rail — Single Post — L-Bracket Mount	8.85"(225mm)	KUP1-0000-USN	\$138.29	\$149.21

Tool Rail — Single Post — L-Bracket Mount

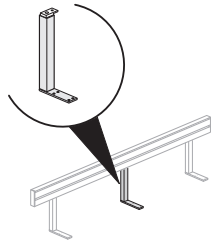

KUP1-0000-USN

Features

- Includes one under horizontal surface L-Bracket mount post and attachment hardware.
- Post is 1.25"(32mm) thick.

Specification Tips

- For use with under horizontal surface mount tool rail.
- Single Support Post may interfere with central casting.
- Monitor arm cannot be mounted in post position.
- Extra single posts can be ordered when additional support for monitor arms and paper management are attached to Tool Rail.

To Order, Specify:

- 1) Product number.
- 2) Trim color.

Work Tools — Mounting

Belong

Tool Rail — Single Sided Continuous Benching End

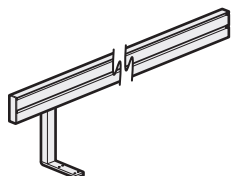

KUR1-1224-USE

Rail Height	Width	Description	Number	Trim A	B
4"(102mm)	24"(610mm)	End	KUR1-1224-USE	\$445.87	\$465.88
	30"(762mm)		KUR1-1230-USE	469.54	491.37
	36"(914mm)		KUR1-1236-USE	493.21	516.86
	42"(1067mm)		KUR1-1242-USE	516.88	542.35
	48"(1219mm)		KUR1-1248-USE	540.55	567.84
	54"(1372mm)		KUR1-1254-USE	564.22	593.33
	60"(1524mm)		KUR1-1260-USE	709.83	740.76
	66"(1676mm)		KUR1-1266-USE	749.82	784.39
	72"(1829mm)		KUR1-1272-USE	789.81	824.38
	78"(1981mm)		KUR1-1278-USE	829.80	866.19
	84"(2134mm)		KUR1-1284-USE	869.79	908.00
	90"(2286mm)		KUR1-1290-USE	909.78	949.81
	96"(2438mm)		KUR1-1296-USE	949.77	991.62

Features

- One single sided tool rail with one or two posts, one rail end cap and attachment brackets.
- Tool Rails 66"-96" includes two posts.
- Mounts under 1.19"(30mm) thick horizontal surface to support rail tools.
- Belong Work Tools or Jump Stuff Slat Pad Tools may be used; separately specified.
- Tool rail overall height above horizontal surface: 11.18"(284mm).
- Distance between tool rail bottom and top of horizontal surface: 7.44"(189mm).
- Post is 1.25"(32mm) thick.
- Ships unassembled.

To Order, Specify:

- 1) Product number.
- 2) Trim color for tool rail/post.
 - TR-K Charcoal
 - TR-J Graphite
 - TR-FM Snow
- 3) Trim color for tool rail end cap:

Specification Tips

- **Designed for Single Sided Continuous Benching or continuous storage applications only.**
- **For use with another tool rail end or internal tool rail; internal benching single post must be specified.**
- **Tool Rail supports maximum of 40 pounds(18.14kg) evenly distributed on one side.**
- **For continuous benching application, two monitor arms up to 13 pounds each side, requires additional post.**
- **Tool Rail should be specified 6" shorter than screen if both are specified.**
- Can be installed off modular.
- Under horizontal surface: 4"(102mm) of clearance is necessary between back of horizontal surface and pedestal for flat bracket attachment.
- Gap between screen and horizontal surface allows installation of Belong Tool Rail.
- Utility tray provides clearance for installation of Belong Tool Rail.

Note: No more than 6"(152mm) of rail can be extended beyond outside of support.

Work Tools — Mounting

Belong

	Rail Height	Width	Number	Price	
				A	B
Tool Rail — Double-Sided Continuous Benching End Application Only	4"(102mm)	24"(610mm)	KUR2-1224-UBE	\$445.87	\$465.88
		30"(762mm)	KUR2-1230-UBE	469.54	491.37
		36"(914mm)	KUR2-1236-UBE	493.21	516.86
		42"(1067mm)	KUR2-1242-UBE	516.88	542.35
		48"(1219mm)	KUR2-1248-UBE	540.55	567.84
		54"(1372mm)	KUR2-1254-UBE	564.22	593.33
		60"(1524mm)	KUR2-1260-UBE	709.83	740.76
		66"(1676mm)	KUR2-1266-UBE	749.82	784.39
		72"(1829mm)	KUR2-1272-UBE	789.81	824.38
		78"(1981mm)	KUR2-1278-UBE	829.80	866.19
		84"(2134mm)	KUR2-1284-UBE	869.79	908.00
		90"(2286mm)	KUR2-1290-UBE	909.78	949.81
		96"(2438mm)	KUR2-1296-UBE	949.77	991.62

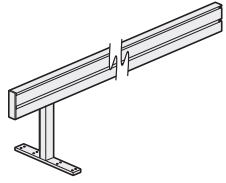

KUR2-1224-UBE

Features

- One double sided tool rail with one or two posts, one rail end cap and attachment brackets.
- Tool Rails 66"(1676mm)-96"(2438mm) include two posts.
- Mounts under 1.19"(30mm) thick worksurface to support rail tools.
- Belong Work Tools or Jump Stuff Slat Pad Tools may be used; separately specified.
- Tool rail overall height above worksurface: 11.18"(284mm).
- Distance between tool rail bottom and top of worksurface: 7.44"(189mm).
- Post is 1.25"(32mm) thick.
- Ships unassembled.

To Order, Specify:

- 1) Product number.
- 2) Trim color for tool rail/post.
 - TR-K Charcoal
 - TR-J Graphite
 - TR-FM Snow
- 3) Trim color for tool rail end cap:

Specification Tips

- **Designed for Continuous Benching applications only.**
- **For use with another tool rail end or internal tool rail; internal benching single post must be specified.**
- **Tool Rail supports maximum of 40 pounds(18.14kg) evenly distributed on each side.**
- **For continuous benching application, two monitor arms up to 13 pounds each side, requires additional post.**
- **Tool Rail should be specified 6"(152mm) shorter than screen if both are specified.**
- **For back-to-back application, 1 or 2 monitors up to 13 grounds each side, requires additional post.**
- Can be installed off modular.
- Under worksurface: 4"(102mm) of clearance is necessary between back of worksurface and pedestal for flat bracket attachment.
- Gap between screen and horizontal surface allows installation of Belong Tool Rail.
- Utility tray provides clearance for installation of Belong Tool Rail.
- Posts mount centered within 3.65"(93mm) gap.
- Refer to Specification Guide for planning rules.

Note: No more than 6"(152mm) of rail can be extended beyond outside of support.

Work Tools — Mounting

Belong

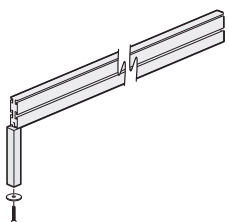
	Rail Height	Width	Description	Number	Trim A	B
Tool Rail — Internal Single Sided Continuous Benching Application  KUR1-1224-USI	4"(102mm)	24"(610mm)	Internal	KUR1-1224-USI	\$445.87	\$465.88
		30"(762mm)		KUR1-1230-USI	469.54	491.37
		36"(914mm)		KUR1-1236-USI	493.21	516.86
		42"(1067mm)		KUR1-1242-USI	516.88	542.35
		48"(1219mm)		KUR1-1248-USI	540.55	567.84
		54"(1372mm)		KUR1-1254-USI	564.22	593.33
		60"(1524mm)		KUR1-1260-USI	709.83	740.76
		66"(1676mm)		KUR1-1266-USI	749.82	784.39
		72"(1829mm)		KUR1-1272-USI	789.81	824.38
		78"(1981mm)		KUR1-1278-USI	829.80	866.19
		84"(2134mm)		KUR1-1284-USI	869.79	908.00
		90"(2286mm)		KUR1-1290-USI	909.78	949.81
	96"(2438mm)		KUR1-1296-USI	949.77	991.62	

Features

- One single sided tool rail with one or two post and attachment brackets.
- Tool Rails 66"(1676mm)-96"(2438mm) includes two posts.
- Mounts on 1.19"(30mm) thick horizontal surface to support rail tools.
- Belong Work Tools or Jump Stuff Slat Pad Tools may be used; separately specified.
- Tool rail overall height above horizontal surface: 11.18"(284mm).
- Distance between tool rail bottom and top of horizontal surface: 7.44"(189mm).
- Post is 1.25"(32mm) thick.
- Ships unassembled.

To Order, Specify:

- 1) Product number.
- 2) Trim color for tool rail/post.

Specification Tips

- **Designed for Single Sided Continuous Benching or continuous storage applications only.**
- **For use with two rail ends; Internal Benching single post must be specified.**
- **Tool Rail supports a maximum of 40 pounds(18.14kg) evenly distributed on one side.**
- **For use with benching application, 1 or 2 monitors up to 13 pounds each side, requires additional post.**
- Mounts into 0.25"(6mm) gap between shared block connectors or center attachment location on shared column.
- Under horizontal surface: 4"(102mm) of clearance is necessary between back of horizontal surface and pedestal for flat bracket attachment.
- Gap between screen and horizontal surface allows installation of Belong Tool Rail.
- Utility tray provides clearance for installation of Belong Tool Rail.

Work Tools — Mounting

Belong

	Rail Height	Width	Description	Number	Trim A	B
Tool Rail — Internal Continuous Benching Application Only	4"(102mm)	24"(610mm)	Internal	KUR2-1224-UBI	\$445.87	\$465.88
		30"(762mm)		KUR2-1230-UBI	469.54	491.37
		36"(914mm)		KUR2-1236-UBI	493.21	516.86
		42"(1067mm)		KUR2-1242-UBI	516.88	542.35
		48"(1219mm)		KUR2-1248-UBI	540.55	567.84
		54"(1372mm)		KUR2-1254-UBI	564.22	593.33
		60"(1524mm)		KUR2-1260-UBI	709.83	740.76
		66"(1676mm)		KUR2-1266-UBI	749.82	784.39
		72"(1829mm)		KUR2-1272-UBI	789.81	824.38
		78"(1981mm)		KUR2-1278-UBI	829.80	866.19
		84"(2134mm)		KUR2-1284-UBI	869.79	908.00
		90"(2286mm)		KUR2-1290-UBI	909.78	949.81
	96"(2438mm)		KUR2-1296-UBI	949.77	991.62	

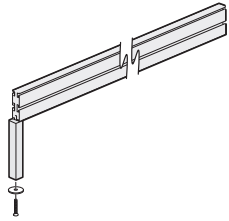

KUR2-1224-UBI

Features

- One double sided tool rail with one or two post and attachment brackets.
- Tool Rails 66"(1676mm)-96"(2438mm) includes two posts.
- Mounts on 1.19"(30mm) thick horizontal surface to support rail tools.
- Belong Work Tools or Jump Stuff Slat Pad Tools may be used; separately specified.
- Tool rail overall height above horizontal surface: 11.18"(284mm).
- Distance between tool rail bottom and top of horizontal surface: 7.44"(189mm).
- Post is 1.25"(32mm) thick.
- Ships unassembled.

To Order, Specify:

- 1) Product number.
- 2) Trim color for tool rail/post.

Specification Tips

- **Designed for Continuous Benching and continuous storage applications only.**
- **For use with two rail ends; Internal Benching single post must be specified.**
- **Tool Rail supports a maximum of 40 pounds(18.14kg) evenly distributed.**
- **Tool Rail should be specified 6" shorter than screen if both are specified.**
- **For use with benching application, 1 or 2 monitors up to 13 pounds each side, requires additional post.**
- Mounts into 0.25"(6mm) gap between shared block connectors or center attachment location on shared column.
- Under horizontal surface: 4"(102mm) of clearance is necessary between back of horizontal surface and pedestal for flat bracket attachment.
- Gap between screen and horizontal surface allows installation of Belong Tool Rail.
- Utility tray provides clearance for installation of Belong Tool Rail.
- Posts mount centered within 3.65"(93mm) gap.

Note: No more than 6"(152mm) of rail can be extended beyond outside of support.

	Post Height	Description	Number	Trim A	B
Tool Rail — Single Post Internal/Benching	8.9"(226mm)	Internal	KUP2-0000-UBI	\$138.29	\$149.21

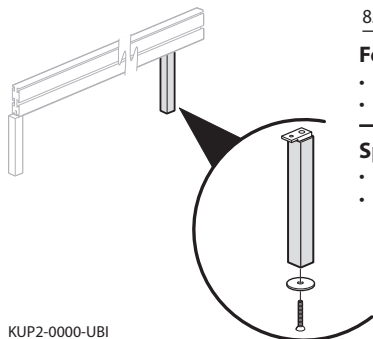

KUP2-0000-UBI

Features

- Includes one Internal position post and attachment hardware.
- Post is 1.25"(32mm) thick.

To Order, Specify:

- 1) Product number.
- 2) Trim color.

Specification Tips

- For use with benching mount tool rail.
- Mounts into 0.25"(6mm) gap between shared block connectors or center attachment location on shared column.

Work Tools

Belong

	Actual Height	Actual Depth	Actual Width	Weight Pounds	Number	Trim A	B
Belong Systems Tile — External Mount for use with Compose Panels	With Slots						
	7.87"(200mm)	1.36"(35mm)	24"(610mm)	4.8 (2.2kg)	KZTB-0824-S	\$213.66	\$230.69
			30"(762mm)	6.0 (2.7kg)	KZTB-0830-S	233.52	261.89
			36"(914mm)	7.1 (3.2kg)	KZTB-0836-S	253.38	293.09
			42"(1067mm)	8.2 (3.7kg)	KZTB-0842-S	273.24	324.29
			48"(1219mm)	9.3 (4.2kg)	KZTB-0848-S	293.10	355.49
	Without Slots						
	7.87"(200mm)	1.36"(35mm)	24"(610mm)	5.4 (2.4kg)	KZTB-0824-N	\$133.88	\$150.91
			30"(762mm)	6.6 (3.0kg)	KZTB-0830-N	153.74	182.11
			36"(914mm)	7.8 (3.5kg)	KZTB-0836-N	173.60	213.31
		42"(1067mm)	9.1 (4.1kg)	KZTB-0842-N	193.46	244.51	
		48"(1219mm)	10.3 (4.7kg)	KZTB-0848-N	213.32	275.71	

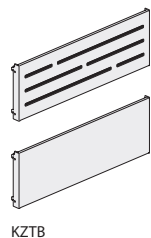

Features

- Includes one steel external mount Systems Tile with or without slots with integrated attachment brackets for use with Compose Panel Frames with Tiles.
- Supports maximum weights of:
 - 24"(610mm) - 15 pounds (6.8kg).
 - 30"(762mm) - 17 pounds (7.7kg).
 - 36"(914mm) - 17 pounds (7.7kg).
 - 42"(1067mm) - 20 pounds (9.0kg).
 - 48"(1219mm) - 20 pounds (9.0kg).
- Non-writable, magnetic surface.

To Order, Specify:

- 1) Product number.
- 1) Trim color.

Specification Tips

- Designed for use with Compose Panel Frames with Tiles only.
- Nominal height is 8"(203mm).
- To be installed in panel frame slots on same width panel, a combination of panels equal to tile width.
- Vertical panel frame face dimensions:
 - Panel frame/non-raceway cover = frame height minus 2"(51mm).
 - Panel frame with raceway cover = frame height minus 10"(254mm).
- For use with separately specified Belong or Jump Stuff work tools.

Work Tools

Belong

	Height	Depth	Width	Description	Number	Trim	
						A	B
Open C Cubby	9"(229mm)	10"(254mm)	15"(381mm)	No Slots	KUCU-0915-BNN	\$159.56	\$178.54
	12"(305mm)	10"(254mm)	15"(381mm)	No Slots	KUCU-1215-BNN	167.17	186.15
	12"(305mm)	10"(254mm)	15"(381mm)	With Slots	KUCU-1215-BNS	186.15	205.13

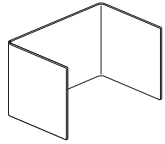

KUCU-0915-BNN

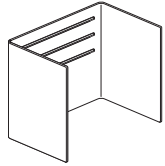

KUCU-1215-BNS

Features

- Includes one freestanding Open C Cubby.
- Freestanding Open C Cubby's are designed for supporting binders and books.
- Open C Cubby with slots allows use of Belong Work Tools or Jump Stuff Slat Pad work tools; separately specified.

To Order, Specify:

- 1) Product number.
- 2) Trim color.

Trays

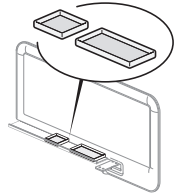

KUAK

Description	Number	Price
Square Tray	KUAK-0000-NSN	\$193.84
Rectangular Tray	KUAK-0000-NNR	193.84

Features

- Includes one plastic tray.
- Sizes:
 - Square tray: 2.75"(70mm).
 - Rectangular tray: 2.75" x 5.5"(70mm x 140mm).
- Available in Beige (TR-R), Brownstone (TR-1R), Rusty Red (TR-RR) and Snow (TR-FM).

To Order, Specify:

- 1) Product number.
- 2) Trim finish.

Specification Tip

- Designed for use with the Base Tray, Territory Screen or as freestanding pieces.

Work Tools

Belong

	Actual Height	Actual Depth	Actual Width	Weight Pounds	Description	Number	Trim A	B
Base Tray	2.09"(53mm)	3.55"(90mm)	23.75"(603mm)	5.0 (2.3kg)	With Accessory Kit	KUBT-0224-A	\$496.33	\$514.59
					Without Accessory Kit	KUBT-0224-N	432.41	450.67

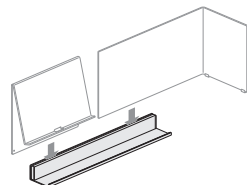

KUBT
GSA: Open Market

Features

- Includes one freestanding steel Base Tray with aluminum insert rail.
- Base Tray is available with or without Accessory Kit.

Specification Tips

- Designed for use with L-Screen, Reference Shelf and Accessory Kit.
- L-Screen and Reference Shelf slide into space between steel back and aluminum insert.
- Base Tray accommodates one Reference Shelf and one L-Screen.
- Accessory Kit is designed to sit on 2.84"(72mm) deep base tray ledge.

To Order, Specify:

- 1) Product number.
- 2) Trim color.

Desk Top L-Screen	11.87"(301mm)	10"(254mm)	23.75"(603mm)	9.7 (4.4kg)	Right-hand	KULS-0000-TR	\$174.87	\$192.90
					Left-hand	KULS-0000-TL	174.87	192.90

Left-hand

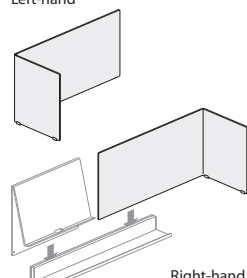

Right-hand

KULS

Features

- Includes one steel Desk Top L-screen with semi-transparent plastic feet.
- Non-writable, magnetic surface.
- Desk Top L-Screen is handed.
- Supports maximum weight of 5 pounds (2.3kg).

Specification Tips

- Designed for use with Base Tray or as freestanding.
- Desk Top L-Screen may be used alone in Base Tray or with Reference Shelf.
- Depth portion of L-Screen, when used adjacent to Reference Shelf, is the same width as Base Tray; width portion of L-Screen perpendicularly wraps around Base Tray ledge.
- Width portion of Desk Top L-Screen may be positioned to fill Base Tray or a portion may overhang past end of Base Tray to accommodate Reference Shelf.

To Order, Specify:

- 1) Product number.
- 2) Trim color.

Desk Top Reference Shelf	12.03"(306mm)	4.25"(108mm)	14.5"(368mm)	8.1 (3.7kg)		KURS-0014-T	\$142.47	\$151.99
---------------------------------	---------------	--------------	--------------	-------------	--	-------------	-----------------	-----------------

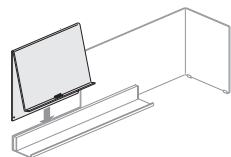

KURS

Features

- Includes one steel desk Top Reference Shelf.
- Desk Top Reference Shelf lip is 1"(25mm) deep with a 15 degree angle.
- Includes a cutout for cord drop if used for charging of electronic devices.
- Supports maximum weight of 5 pounds (2.3kg).
- Non-writable, magnetic surface.

Specification Tips

- Desk Top Reference Shelf may not be used alone in Base Tray; must be used together with Desk Top L-Screen for support purposes.
- Desk Top Reference Shelf is not freestanding.
- Desk Top Reference Shelf adjacent to depth portion of L-Screen are the same width as Base Tray; width portion of L-Screen perpendicularly wraps around Base Tray ledge.
- Desk Top Reference Shelf adjacent to width portion of L-Screen will overhang past end of Base Tray.

To Order, Specify:

- 1) Product number.
- 2) Trim color.

Work Tools

Belong

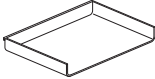
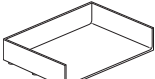
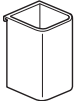
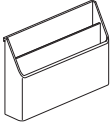
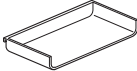
	Height	Depth	Width	Description	Number	Price
Paper Tray — Landscape  KUPT-0913-H  KUPT-0913-F	1.5"(38mm)	8.875"(225mm)	12.75"(324mm)	Slat — Document Tray	KUPT-0913-H	\$39.89
	2.5"(38mm)	8.875"(225mm)	12.75"(324mm)	Freestanding — Stacking Tray	KUPT-0913-F	47.50
Features <ul style="list-style-type: none"> Includes one plastic tray. Slat document tray mounts on Belong rail, Belong slat tile and Compose slat tile. Slat document tray supports maximum of one ream (5 pounds/2.3kg) of paper. Freestanding stacking tray is freestanding and stacks 4 high. 						
To Order, Specify: <ol style="list-style-type: none"> Product number. Trim color. <ul style="list-style-type: none"> TR-R Beige TR-1R Brownstone TR-RR Rusty Red TR-FM Snow <p>Note: Snow (TR-FM) plastic trim color is not recommended for use with painted trim colors Plaster (TR-TW) or Chalk (TR-AK). Refer to Very' Seating chainset for Snow.</p>						
Tool Cup  KUTC-0000-H	3.5"(90mm)	2.5"(38mm)	2.5"(38mm)		KUTC-0000-H	\$34.20
	Features <ul style="list-style-type: none"> Includes one plastic tool cup. Tool cup mounts on: <ul style="list-style-type: none"> —Belong rail —Belong slat tile —Open C Cubby with slots —Compose slat tile Can also be used in freestanding applications. 					
To Order, Specify: <ol style="list-style-type: none"> Product number. Trim color. <ul style="list-style-type: none"> TR-R Beige TR-1R Brownstone TR-RR Rusty Red TR-FM Snow <p>Note: Snow (TR-FM) plastic trim color is not recommended for use with painted trim colors Plaster (TR-TW) or Chalk (TR-AK). Refer to Very' Seating chainset for Snow.</p>						
Hanging Sorter  KUHS-0000-H	8.5"(216mm)	2.5"(64mm)	12.75"(324mm)		KUHS-0000-H	\$93.10
	Features <ul style="list-style-type: none"> Includes one hanging sorter with two paper sorters. Interior depth of each sorter is 1"(25mm). Hanging sorter mounts on: <ul style="list-style-type: none"> —Belong rail —Belong slat tile —Open C Cubby with slots —Compose slat tile 					
To Order, Specify: <ol style="list-style-type: none"> Product number. Trim color. <ul style="list-style-type: none"> TR-R Beige TR-1R Brownstone TR-RR Rusty Red TR-FM Snow <p>Note: Snow (TR-FM) plastic trim color is not recommended for use with painted trim colors Plaster (TR-TW) or Chalk (TR-AK). Refer to Very' Seating chainset for Snow.</p>						
Mini Shelf  KUSH-0408-H	1"(25mm)	4"(102mm)	8"(203mm)		KUSH-0408-H	\$34.20
	Features <ul style="list-style-type: none"> Includes one plastic shelf. Mini shelf mounts on: <ul style="list-style-type: none"> —Belong rail —Belong slat tile —Open C Cubby with slots —Compose slat tile 					
To Order, Specify: <ol style="list-style-type: none"> Product number. Trim color. <ul style="list-style-type: none"> TR-R Beige TR-1R Brownstone TR-RR Rusty Red TR-FM Snow <p>Note: Snow (TR-FM) plastic trim color is not recommended for use with painted trim colors Plaster (TR-TW) or Chalk (TR-AK). Refer to Very' Seating chainset for Snow.</p>						

Work Tools

Belong

	Depth	Width	Edge	Number	Fabric Grade	
					D	E
Blotter	19.7"(500mm)	29.5"(749mm)	3mm	KUBL-2030-FJ	\$775.04	\$818.96
	19.7"(500mm)	35.4"(899mm)		KUBL-2036-FJ	794.11	841.84
	23.6"(599mm)	35.4"(899mm)		KUBL-2436-FJ	813.18	864.72
	19.7"(500mm)	29.5"(749mm)	Knife	KUBL-2030-FF	\$775.04	\$818.96
	19.7"(500mm)	35.4"(899mm)		KUBL-2036-FF	794.11	841.84
	23.6"(599mm)	35.4"(899mm)		KUBL-2436-FF	813.18	864.72

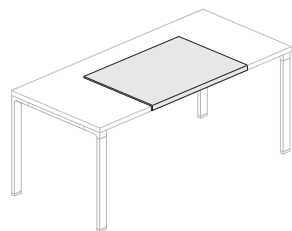

KUBL-2030-FJ

Features

- Includes one blotter with protective back.
- Specify blotter profile to match desking edge:
 - 3mm Edgeband
 - Knife edge
- Belong Blotter radius is 0.5"(13mm).

To Order, Specify:

- 1) Product number.
- 2) Fabric

Specification Tips

- 20"(508mm) deep blotter can be used on 24"(610mm) deep desking without hatch.
- 20"(508mm) deep blotter can be used on 30"(762mm) deep desking with hatch.
- 24"(610mm) deep blotter can be used on 36"(914mm) deep desking with hatch.

Reference Shelves



KURS-0010-H

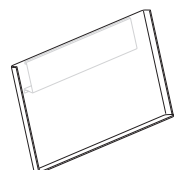

KURS-0019-H

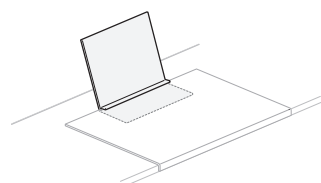

KURS-0012-B

Height	Width	Description	Number	Trim	
				A	B
11.25"(286mm)	9.875"(251mm)	Reference — Small	KURS-0010-H	\$ 94.97	\$104.49
	18.5"(470mm)	Reference — Large	KURS-0019-H	142.47	151.99
9.875"(251mm)	11.625"(295mm)	Blotter Reference Shelf	KURS-0012-B	\$ 94.97	\$104.49

Features

- Includes one metal reference shelf
- Large and Small Reference shelves mount on:
 - Belong rail
 - Belong slat tile
 - Open C Cubby with slots
- Blotter Reference Shelf slides under blotter for support.

To Order, Specify:

- 1) Product number.
- 2) Trim color.

Specification Tips

- In installed position large and small referencing shelves are 0.88"(22mm) high and 4.3"(109mm) deep.
- Reference shelf lip is 1.375"(35mm) deep.

Accessory Kit

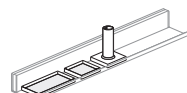

KUAK

GSA: Open Market

	Number	Price
	KUAK-0000-BSR	\$191.76

Features

- Includes one square tray, one rectangular tray and bud vase with square base. All items are plastic.
- Sizes:
 - Square tray: 2.75"(70mm).
 - Rectangular tray: 2.75" x 5.5"(70mm x 140mm).
 - Bud Vase: 4"(102mm) tall, 0.75"(19mm) inside diameter, 2.75"(70mm) square base.
- Designed for use with the Base Tray, Territory Screen or as freestanding pieces.
- Standard in snow trim color.

To Order, Specify:

- 1) Product number.
(No finish specification required)

Note: Snow (TR-FM) plastic trim color is not recommended for use with painted trim colors Plaster (TR-TW) or Chalk (TR-AK). Refer to Very Seating chainset for Snow.

Work Tools

Jump Stuff

	Height	Depth	Width	Number	Trim A	B
Paper Sorter	9.25"(235mm)	11"(279mm)	9"-12"(229mm-305mm)	DTPR-3	\$116.28	\$120.35

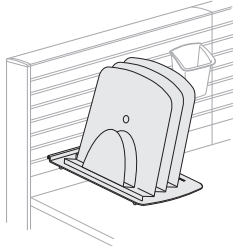

DTPR-3

Features

- Includes three dividers, one shelf, and mounting bracket.
- Mounts on slat pad.
- Can also be used as a horizontal freestanding tray.
- Supports maximum of two reams (ten pounds/4.6 kilograms) of paper.

To Order, Specify:

- 1) Product number.
- 2) Translucent trim color.
- 3) Trim color for bracket.

	Height	Depth	Width	Number	Price
Binder Bin	12.5"(318mm)	10.5"(267mm)	6.5"(165mm)	DTSB-3	\$87.72

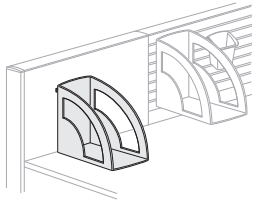

DTSB-3

Features

- Mounts on slat pad. Can also be used in freestanding applications.
- Bin accommodates two 3"(76mm) thick binders.

To Order, Specify:

- 1) Product number.
- 2) Translucent trim color.

	Height	Depth	Width	Number	Laminate A	B
Mini Shelf	1.75"(44mm)	6.25"(159mm)	18"(457mm)	DMSP-18	\$178.67	\$192.94
			24"(610mm)	DMSP-24	186.84	201.11

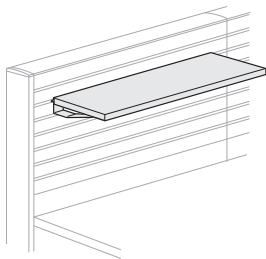

DMSP

Features

- Includes shelf and brackets.
- Mounts on slat pad.
- Shelf thickness 0.75"(19mm)
- Designed for lightweight accessories.

To Order, Specify:

- 1) Product number.
- 2) Shelf trim color.
- 3) Edgeband color.
- 4) Trim color for brackets.

	Height	Depth	Width	Number	Trim A	B
Phone Shelf	2.5"(64mm)	11.25"(286mm)	9"(229mm)	DTPT-3	\$138.71	\$142.78

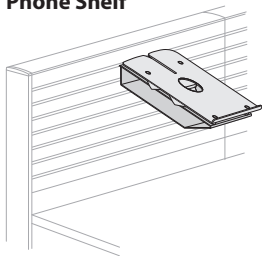

DTPT-3

Features

- Includes phone shelf and bracket.
- Mounts on slat pad at 30° angle.
- Supports maximum of two reams (ten pounds/4.6 kilograms) of paper.

To Order, Specify:

- 1) Product number.
- 2) Translucent trim color.
- 3) Trim color for bracket.

Work Tools

Jump Stuff

	Height	Depth	Width	Number	Price
Letter Tray	2.5"(64mm)	12"(305mm)	10.5"(267mm)	DTLT-2	\$42.86

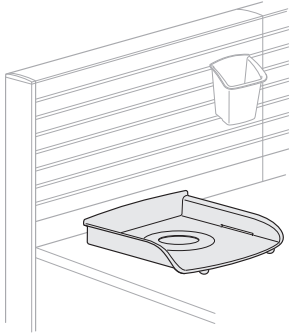

DTLT-2

Features

- Used in freestanding applications.

To Order, Specify:

- 1) Product number.
- 2) Translucent trim color.

	Height	Depth	Width	Description	Number	Price
Waste Bin	15.5"(394mm)	12"(305mm)	13"(330mm)	Translucent	DTRB-1	\$111.79

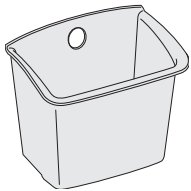

DTRB
GSA: Open Market

Features

- Used in freestanding applications.
- Five gallon capacity.

To Order, Specify:

- 1) Product number.
- 2) Translucent trim color.
TR-LQ Frost

Work Tools

Magnetic Accessories

	Actual Height	Actual Width	Number	Price
Magnet Board	11"(279mm)	4"(102mm)	KUAM-0411	\$43.90
	18"(457mm)	5"(127mm)	KUAM-0518	87.80

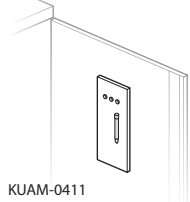

KUAM-0411

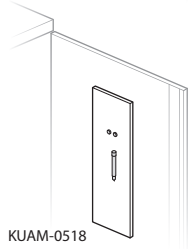

KUAM-0518

Features

- Includes:
 - Magnetic dry-erase board
 - Three round magnets on 11"(279mm) high magnet board, two round magnets on 18"(457mm) high magnet board
 - One magnetic dry erase pen
 - Magnetic attachment strip for attachment to magnetic surfaces
 - Adhesive strip for attachment to non-magnetic surfaces
- Available in white (not matched to Haworth's color palette).

To Order, Specify:

- Product number.

Specification Tip

- Use on non-textured surfaces for best performance.

Magnet Hooks

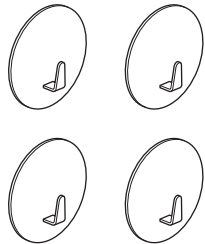

KUAH-0002

Diameter	Number	Price
1.5"(38mm)	KUAH-0002	\$42.17

Features

- Includes four 1.5"(38mm)-diameter magnetic hooks for holding personal items.
- Available in white (not matched to Haworth's color palette).

To Order, Specify:

- Product number.

Specification Tip

- Use on non-textured surfaces for best performance.

Magnet Hook



KUAH-0003

Diameter	Number	Price
3"(76mm)	KUAH-0003	\$27.87

Features

- Includes one 3"(76mm)-diameter magnetic hook for holding personal items.
- Available in white (not matched to Haworth's color palette).

To Order, Specify:

- Product number.

Specification Tip

- Use on non-textured surfaces for best performance.

Round Peg Magnets

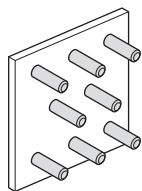

KUAP-0000

Depth	Diameter	Number	Price
0.375"(10mm)	0.16"(4mm)	KUAP-0000	\$42.17

Features

- Includes eight round magnets and one magnetic attachment strip.
- Available in white (not matched to Haworth's color palette).

To Order, Specify:

- Product number.

Specification Tip

- Use on non-textured surfaces for best performance.
- Each magnet can hold up to eight sheets of letter-size paper.

OBSOLETE | Feb 2024

Mirror

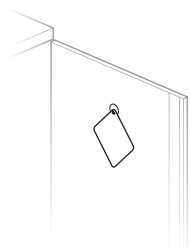

KUAR-0403

Actual Width	Actual Length	Number	Price
3.125"(80mm)	4.375"(111mm)	KUAR-0403	\$29.84

Features

- Includes one acrylic mirror.
- Can be hung from a Belong magnetic hook, or placed in a Belong pouch (specified separately).

To Order, Specify:

- Product number.
(No color specification required.)

Workstation Accessories

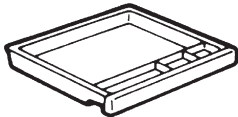
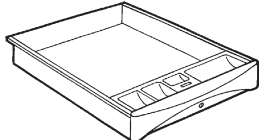
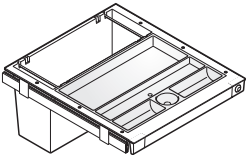
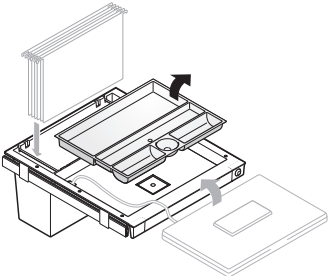
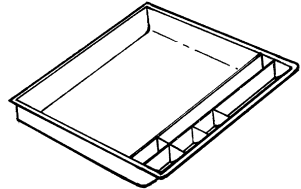
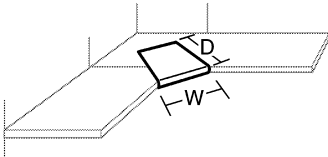
	Height	Depth	Width	Number	Price
<p>Shallow Drawer</p>  <p>DS-3 Class AA – SIN 33721; Discount Group I</p>	3"(76mm)	15.375"(391mm)	18.25"(464mm)	DS-3	\$159.64
<p>Features</p> <ul style="list-style-type: none"> Includes one drawer and attachment hardware. Shallow drawer has four compartments. Drawer does not stack. Available in charcoal or gray tone finish colors only. 	<p>To Order, Specify:</p> <ol style="list-style-type: none"> Product number. Trim color. TR-K Charcoal TR-G Gray Tone 				
<p>Steel Center Drawer</p>  <p>SCD-19 Class MA – SIN 33721; Discount Group II</p>	2"(51mm)	17.5"(445mm)	19.125"(486mm)	SCD-19	\$468.32
<p>Features</p> <ul style="list-style-type: none"> Includes mounting hardware. Standard with lock. Standard in charcoal finish color only. 	<p>To Order, Specify:</p> <ol style="list-style-type: none"> Product number. (No finish specification required.) 				
<p>Pencil + Drawer</p>   <p>KUDP-2420 Class YA – SIN 33721; Discount Group XIII</p>	11"(279mm)	24"(610mm)	19.5"(495mm)	KUDP-2420	\$567.80
<p>Features</p> <ul style="list-style-type: none"> Multi-purpose drawer provides organization, hanging filing along with laptop storage. Knock-outs at rear of drawer provide electronic charging access while contents are locked. Removable organizing tray. Thin profile maximizes knee clearance under front of drawer. Standard in black trim color with black locks. Standard with lock (shipped separately); keyed-alike and master keying options available. 	<p>To Order, Specify:</p> <ol style="list-style-type: none"> Product number. (No finish specification required.) 				
<p>Specification Tips</p> <ul style="list-style-type: none"> To be mounted below worksurfaces 24"(610mm) or deeper. Not for use with 24"(610mm) deep knife edge worksurface. Pencil + drawer must be used adjacent to worksurface floor support when specified for use with panel system. 					
<p>Pencil Drawer</p>  <p>JAC-18 Class FP – SIN 33721; Discount Group XII</p>	1.625"(41mm)	19"(483mm)	18"(457mm)	JAC-18	\$117.38
<p>Features</p> <ul style="list-style-type: none"> Includes black plastic drawer, slides, and mounting hardware. Attaches under freestanding desks, returns, bridges, system convergent or rectangular worksurfaces. 	<p>To Order, Specify:</p> <ol style="list-style-type: none"> Product number. (No finish specification required.) 				
<p>Specification Tip</p> <ul style="list-style-type: none"> Do not install in area where cantilever bracket is installed. 					
<p>Make-A-Corner</p>  <p>MAC-001 Class AA – GSA: Open Market</p>	21.125"(537mm)	26.125"(664mm)	MAC-001		\$283.56
<p>Features</p> <ul style="list-style-type: none"> Creates an angled edge between two (2) perpendicular regular worksurfaces. Slides over the top of 1.19"(30mm) thick worksurfaces. Accommodates an adjustable keyboard or mouse pad track (screws included). 	<p>To Order, Specify:</p> <ol style="list-style-type: none"> Product number. Non-metallic trim color. 				

Workstation Accessories

	Height	Width	Depth	Number	Trim A	B
Compose All-Purpose Hook	1.375"(35mm)	0.5"(13mm)	0.75"(19mm)	VZAC-0000-P	\$565.07	\$588.25
	1.375"(35mm)	0.625"(16mm)	3.375"(86mm)	VZAC-0000-H	536.57	559.75

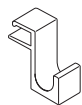

VZAC-0000-P

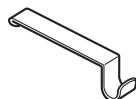

VZAC-0000-H
Class BC – SIN 33721,
Discount Group XI

Features

- Includes eight coat hooks.
- (P) For use with full profile aluminum trim.
- (H) For use with thin profile steel trim.

To Order, Specify:

- 1) Product number.
- 2) Trim color.

Specification Tip

- Attaches to Compose panel frame or stack frame top with trim.

Note: Not available for use on Glass panels or glass stacks.

PLACES All-Purpose Hook	1"(25mm)	3"(76mm)	0.5"(13mm)	HCH-0008	\$231.98	
--------------------------------	----------	----------	------------	----------	-----------------	--

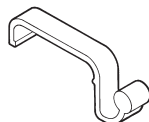

HCH-0008
Class BA – SIN 33721,
Discount Group I

Features

- Includes eight hooks.
- Attaches to PLACES steel top cap panels only.

To Order, Specify:

- 1) Product number.
- 2) Trim color.

UniGroup All-Purpose Hook	1"(25mm)	3"(76mm)	0.625"(16mm)	CH-8	\$181.26	
----------------------------------	----------	----------	--------------	------	-----------------	--



CH-8
Class AA – SIN 33721,
Discount Group I

Features

- Includes eight hooks.
- Attaches to panel steel top cap.
- For use with UniGroup panels only.

To Order, Specify:

- 1) Product number.
- 2) Trim color.

	Number	Trim A	B
UniGroup Too All Purpose Hook	E2CH-8	\$166.40	\$195.74



E2CH-8
Class AC – SIN 33721,
Discount Group I

Features

- Includes eight hooks.
- For use with UniGroup Too square painted top cap panels.

To Order, Specify:

- 1) Product number.
- 2) Trim color.

	Number	Trim A	B
Bag Hook	KUWH-0202	\$59.92	\$67.80

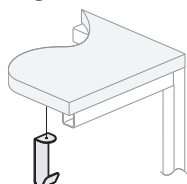

KUWH-0202
Class YA – GSA: Open Market

Features

- Includes one hook and attachment hardware.
- Hook will swivel if plastic washers are installed.

To Order, Specify:

- 1) Product number.
- 2) Trim color.

Specification Tips

- Attaches to the bottom of the 1.19"(30mm) and 2"(51mm) thick top.
- Weight Limit 50 lbs max.

Workstation Accessories

2/90 Sign Systems

2/90 Sign Systems is a recommended signage program for use with Haworth Systems. Signage options include ADA-compliant panel-mounted name signs, department signs, building directories, in/out boards, restroom and no smoking signs.

For inquiries, catalogs or orders, contact System 2/90 directly at 1-800-777-4310, fax (616) 656-4300, 5350 Corporate Grove Blvd SE, Grand Rapids, MI 49512.

Lock Programs

Specification Guidelines

Locking Components Shipping Format

Locking components in all Haworth systems, casegoods, files and storage furniture are shipped with the lock housings factory-installed in each unit ready to receive separate lock plug cores. Lock plugs are field installed by means of a control key. Lock plugs and keys will be shipped with random numbering unless they are specified "keyed-alike". Quantity of locks will match quantity required for locking components on the order.

HW Lock Program

All HW lock plugs and keys will be standard in a Master Lock Program. A Master Lock program allows for better management of the facility where one "Master Key" can be used by Facility Management to service all locking components within a facility. Individual offices can be keyed-alike and will receive single-key access specific to the locking components within that workstation. Multiple locks in credenza components should be keyed-alike for the convenience of single-key access. General storage or file areas may also be keyed-alike so that individuals may have access to shared department documents or supplies.

To order new products within a workstation keyed-alike, the specifier should select the number of locks within the workstation and specify LSET quantities through Orderline. CSET lock plug and keys are to key-alike existing product for reconfigurations.

On Site Lock Installation

One Control Key for installing the lock plug will be included with each incremental order unit of up to 200 locks. The control key is used to insert and remove the lock plug into the housing at the installation site. The control key cannot be used to remove a lock plug in the locked position from its housing. Additional control keys are available and should be considered for the convenience of installing locks in widely separated areas of a facility (see Keys Only, page 214).

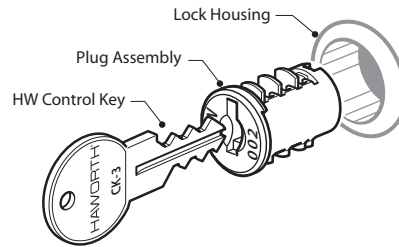

Replacement Lock Plugs and Keys

To order replacement lock plugs and keys, use the appropriate service parts catalog number or CSETS.

Coding the Office Plan

Each lock location should be identified graphically on the plan by a dash mark. Encode your office floor plan by using your own coding system to identify each workstation or area that requires keyed-alike locks. Remember that some furniture will have more than one lock — a double pedestal desk, for instance. The coded floor plan with office identification numbers and lock quantities and color code will be required at the time of installation. The installer will be responsible for assignment of lock quantities based on this plan.

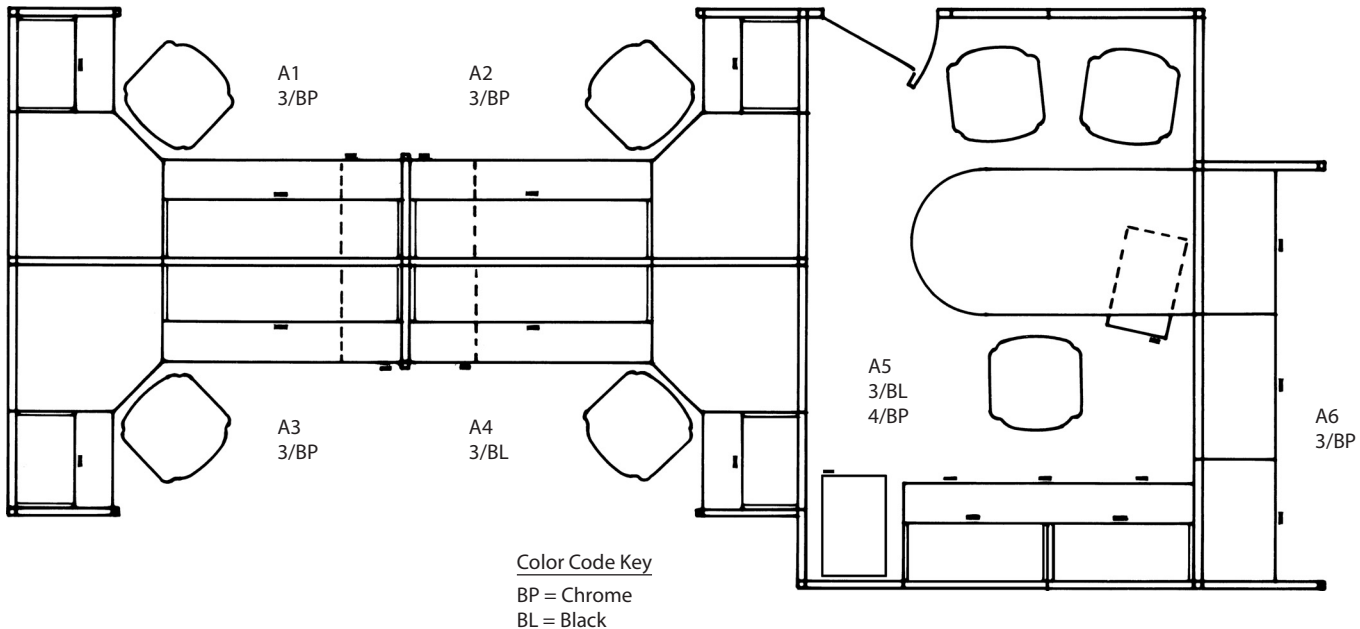

Lock Programs

HW Lock Program

HW Lock Program The Haworth HW Lock Program is a Master Lock Program and offers the option to have workstations keyed-alike with 300 lock numbers. LSET keyed-alike lock plugs/keys are for new locking product orders only and are available at no charge.

For reconfiguration projects, there are CSET lock plugs and keys available at a nominal charge.

Work Sheet Preparation Photocopy the HW Lock Work Sheet to assist in specifying locks. This work sheet is for your convenience and is not to be submitted with your purchase order.

Using the Coded Office Plan Enter the workstation or area identification codes from the plan into the columns headed OFFICE NUMBER on the HW Lock work sheet. The work sheet can accommodate 100 location entries.

Specifying Keyed-Alike Lock Quantities and Colors Using the plan, count the number of locking components in each workstation. Enter the number of locks under "QUANTITY" columns, taking into account the chrome or black finish, depending on lock finishes offered. When completed, each workstation should be assigned a quantity of LSETs. For file banks or storage areas requiring a larger quantity of the same lock numbers, specify LSET-999.

NO KEYED-ALIKE NOTE:
When no LSETS are specified, plugs and keys for the total number of locking components will be shipped automatically.

A Master Key will need to be separately specified.

Example:

Office Number	Quantity		LSET Number	Totals	
	Chrome	Black		Chrome	Black
A1	3		LSET-3	1	
A2	3		LSET-3	1	
A3	3		LSET-3	1	
A4		3	LSET-3		1
A5	4	3	LSET-3		1
			LSET-4	1	
A6	3		LSET-3	1	

Total the number of LSET quantities at the bottom of the work sheet. Transfer each total quantity to your Orderline or written purchase order.

When specifying Keyed-Alike (LSETS): LSETS must be ordered for the total number of locking components. Only the quantity of LSETS ordered will be shipped. We do not ship based upon number of locking components on order.

LSETS ordered in excess of quantities required for new locking product on the order may result in the order being place on hold.

As a final verification of quantity, review the plan carefully to be sure that all products with locks have been identified. Remember that desks, credenzas and storage units may have multiple locking components.

Line Item Entry Transfer the data from the work sheet to your Orderline or written purchase order. Enter the appropriate LSET catalog numbers on your order, followed by finish option code -BP or -BL.

Example:

Quantity	Description
4	LSET-3, LR-BP
1	LSET-4, LR-BL
2	LSET-3, LR-BL

Order Processing and Packing Method Haworth will assign the lock numbers for all keyed-alike orders. Note: Specific key numbers cannot be requested.

Upon receipt of your keyed-alike order, Haworth will draw from our standard inventory of 300 lock numbers. Lock plugs will be shipped according to finish in sets per the quantity specified. HW locks and keys (Figure 3) will carry a stamped "HW" on one side with 1 through 300 on the other side as an indication of the "HW lock" program.

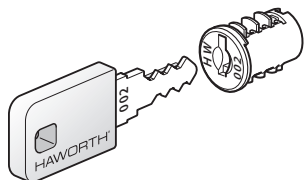

Figure 3.

Order Changes For Order Changes/Cancellations; refer to North American Terms of Sale.

Lock Programs

HW Lock Plugs and Keys

HW Lock Plugs and Keys

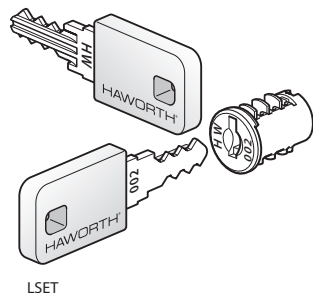

LSET

Description	Number	Price
Order with new product orders only*		
1 Lock Plug and Key	LSET-1	N/C
2 Lock Plugs and Keys	LSET-2	N/C
3 Lock Plugs and Keys	LSET-3	N/C
4 Lock Plugs and Keys	LSET-4	N/C
5 Lock Plugs and Keys	LSET-5	N/C
6 Lock Plugs and Keys	LSET-6	N/C
7 Lock Plugs and Keys	LSET-7	N/C
8 Lock Plugs and Keys	LSET-8	N/C
9 Lock Plugs and Keys	LSET-9	N/C
10 Lock Plugs and Keys	LSET-10	N/C
11 Lock Plugs and Keys	LSET-11	N/C
12 Lock Plugs and Keys	LSET-12	N/C
30 Lock Plugs and Keys	LSET-30	N/C
Key all locks alike (quantities greater than 30)	LSET-999	N/C
Order for reconfiguration of existing product		
1 Lock Plug and Key	CSET-1	\$ 13.63
2 Lock Plugs and Keys	CSET-2	27.26
3 Lock Plugs and Keys	CSET-3	40.89
4 Lock Plugs and Keys	CSET-4	54.52
5 Lock Plugs and Keys	CSET-5	68.15
6 Lock Plugs and Keys	CSET-6	81.78
7 Lock Plugs and Keys	CSET-7	95.41
8 Lock Plugs and Keys	CSET-8	109.04
9 Lock Plugs and Keys	CSET-9	122.67
12 Lock Plugs and Keys	CSET-12	163.56
30 Lock Plugs and Keys	CSET-30	408.90
Key all locks alike (quantities greater than 30)	CSET-999	13.63

Features

- The Haworth HW Lock Program offers 300 lock numbers. LSET keyed-alike lock plugs/keys are for new locking product orders only and are available at no charge. LSET's ordered in excess of quantities required for new locking product on the order may result in order being placed on hold.
- For reconfiguration projects there are CSET lock plugs and keys available at a nominal charge.
- All lock plugs and keys with one LSET/CSET will ship with the same key number which is chosen at random.
- LSET-999 and CSET-999 are for quantities greater than 30 lock plugs and keys. Specify quantity of locks; locks are priced "per piece". Numbers will be the same for all locks and chosen at random.
- Haworth will assign key numbers from the inventory of 1 through 300.
- To order specific key numbers for replacement; refer to page 214.
- Master key available; separately specified.
- Keys are standard in nickel with black overmolded head; Locks plugs are available in chrome and black finishes.

To Order LSET, Specify:

- 1) Product number.
- 2) Lock plug finish color.
LX-BP Chrome
LX-BL Black

To Order CSET, Specify:

- 1) Product number.
- 2) Lock plug finish color.
LR-BP Chrome
LR-BL Black

Lock Programs

Keys

	Key Number Selection	Number	Price
HW Plugs and Keys	KY-001 through KY-300	HW-SVC	\$26.07

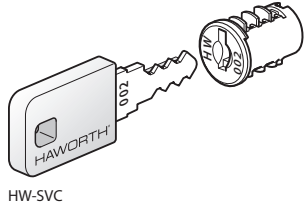

HW-SVC

Features

- Includes one lock plug and one key.
- Keys are standard in nickel with black overmolded head.
- Lock plugs are available in chrome or black finishes.
- One control key (CK-3) for installing lock plugs into lock housings is provided.
- The key number will print on one side of key and HW on other side.
- Lock plug will also show HW and key number (refer to illustrations).

To Order, Specify:

- 1) Product number.
- 2) Lock plug finish color.
LR-BP Chrome
LR-BL Black
- 3) Key number.

HW Replacement Keys

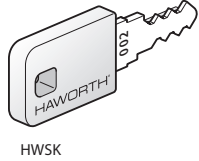

HWSK

Description	Quantity Included	Key Numbers Included	Number	Price
Includes one HW key; specify key number/quantity	1		HWSK-1	\$ 20.65
	50	1-50	HWSK-2	\$ 348.20
	50	51-100	HWSK-3	348.20
	50	101-150	HWSK-4	348.20
	50	151-200	HWSK-5	348.20
	50	201-250	HWSK-6	348.20
	50	251-300	HWSK-7	348.20
	300	1-300	HWSK-300	1848.51

Features

- Includes HW keys only.
- HWSK-1; order for specific HW key number replacement; Specify HW key number.
- HWSK-2 through HWSK-300; specific HW key number series included.

To Order, Specify:

- 1) Product number.
- 2) Key number (HWSK-1 only).
(No finish specification required.)

HW Master Key

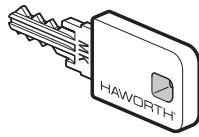

HWMK-1

Description	Number	Price
Master key	HWMK-1	\$22.52

Features

- Includes one key.
- HWMK keys are silver with a red overmolded head.

To Order, Specify:

- 1) Product number.
(No finish specification required.)

Note: Master keys can only be used for HW Lock Program.

HW Control Key



CK-3

Control key (no key number selection required)	CK-3	\$22.52
--	------	---------

Features

- A single control key is provided with each lock shipment.
- CK-3 control key can be used to remove HW lock plug in unlocked position only.

To Order, Specify:

- 1) Product number.
(No finish specification required.)

HW Key Blank

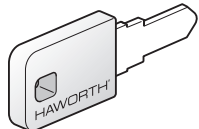

HWKB-1

Key Blank	HWKB-1	\$510.96
-----------	--------	----------

Features

- Includes 100 key blanks for use with HW Lock Program only.

To Order, Specify:

- 1) Product number.
(No finish specification required.)

Lock Programs

Digital Locks

	Length	Width	Height	Number ^{①②③}	Price
Digital Lock	3.88"(98mm)	1"(25mm)	0.75"(19mm)	HUDR-■ ■ - ■ Y	\$911.03

Digital Lock

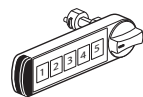

HUDR-R

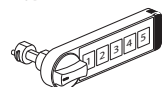

HUDR-L

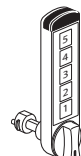

HUDR-B



HUDR-T

Features

- Includes:
 - Digital lock with 5-digit horizontal or vertical keypad and rotating lock knob
 - CR2032 3-volt lithium battery
 - Factory-assigned access code
 - Attachment hardware and spacer for metal and wood surfaces
- Fits standard lock housings in all Haworth systems, caseloads, files and storage furniture.
- Two software versions allow the lock to be programmed by individual users each time it's used, or by a facility manager for workstations where re-programming is infrequent.
- Master codes can be created by facilities management to override factory-assigned access codes.
- Factory or master codes provide manager access and enable re-programming.
- Available in black or brushed chrome.

Specification Tips

- Digital lock installs on Haworth products and fits over existing lock bezel using the included spacer.
- Optional control key fob can be specified separately to manage factory and/or master codes.
- Not applicable on X Series Tug Pedestal.
- User-Programmable (Locker Mode) user programs and codes into lock with each use.
- Facility- Programmed (Station Mode) code programmed for user, same code each use.

To Order, Specify:

- Product number, including:

① Keypad Orientation

- L** Horizontal, knob left
- R** Horizontal, knob right
- T** Vertical, knob top
- B** Vertical, knob bottom

② Knob Rotation

- 090** 90 degree
- 180** 180 degree

③ Software Option

- U** User-programmable (Locker Mode)
- F** Facility-programmed (Station Mode)

- Trim color for lock

Digital Lock Control Key Fob



HUDF-F

Number

HUDF-F

Price

\$828.16

Features

- Includes one control key fob and CR2032 3-volt lithium battery.
- Provides facility management of factory, master, and user codes, allowing management access and re-programming of digital locks (HUDR).
- Stores an unlimited number of factory and master codes.

Specification Tip

- Each lock must be programmed to accept key fob before use.

To Order, Specify:

- Product number.

Lock Programs

Digital Lock Applications

	Lock Location	HUDR-T180 Knob Top	HUDR-B180 Knob Bottom	HUDR-L180 Knob Left	HUDR-R180 Knob Right	HUDR-T090 Knob Top	HUDR-B090 Knob Bottom	HUDR-L090 Knob Left	HUDR-R090 Knob Right
A Series									
Credenza w/Drawers & Doors	Drawer Front	•		•	•				
Adaptable Overhead Storage Unit									
Flipper & Single Slider			•	•	•				
Hinge			•	•					
Be_Hold Accessory Drawer									
Steel Drawer Front	Lower Right of Drawer Front				•				
Be_Hold Stationary Pedestals									
12 Wide w/Steel Drawer	Lower Right of Top Drawer				•				
12 Wide w/Hinged Door on LH Side (LH Unit)	Upper Right of Door Front	•			•				
12 Wide w/Hinged Door on RH Side (RH Unit)	Upper Left of Door Front	•		•					
Box/File & Box/Box/File	Upper Right of Top Drawer	•			Q, W				
File/File	Upper Right of Top Drawer	•			•				
Be_Hold Suspended Pedestal									
w/Steel Drawer	Lower Right of Top Drawer				•				
Door on LH Side (LH Unit)	Upper Right of Door Front	•			•				
Door on RH Side (RH Unit)	Upper Left of Door Front	•		•					
Be_Hold Mobile Pedestal									
12 Wide w/Steel Drawer	Lower Right of Top Drawer				•				
12 Wide w/Hinged Door on LH Side (LH Unit)	Upper Right of Door Front	•			•				
12 Wide w/Hinged Door on RH Side (RH Unit)	Upper Left of Door Front	•		•					
Box/File & Box/Box/File	Upper Right of Top Drawer	•			Q, W				
File/File	Upper Right of Top Drawer	•			•				
Be_Hold Stationary Lateral Files									
Box/File & Box/Box/File, & Cubby/Box/File	Upper Right of Top Drawer	•			•				
Cubby/File, File/File, & File/File/File	Upper Right of Top Drawer	•			•				
Be_Hold Storage Cabinet									
1.5H Double Door	Upper Left of RH Door Front	N, W		•					
2H, & 3H Double Door	Upper Left of RH Door Front	•		•					
1.5H Door on LH Side (LH Unit)	Upper Right of Door Front	N, W			•				
2H, & 3H Door on LH Side (LH Unit)	Upper Right of Door Front	•			•				

Pull Options	
6	Patterns
7	Crescent
8	Linear
9	Classic

Pull Options	
F	Wood Finger Pull
K	Aluminum J-Pull
Q	Blade
W	Wing
N	No Pull

Lock Programs

Digital Lock Applications

	Lock Location	HUDR-T180 Knob Top	HUDR-B180 Knob Bottom	HUDR-L180 Knob Left	HUDR-R180 Knob Right	HUDR-T090 Knob Top	HUDR-B090 Knob Bottom	HUDR-L090 Knob Left	HUDR-R090 Knob Right
Be_Hold Storage Cabinet (cont')									
1.5H Door on RH Side (RH Unit)	Upper Left of Door Front	N, W		•					
2H, & 3H Door on RH Side (RH Unit)	Upper Left of Door Front	•		•					
Double Door 48.5	Middle Left of RH Door Front	N, W	•	•					
Double Door 57.5/65.5/73.5	Middle Left of RH Door Front	•	N, W	•					
Double Door 81.5	Middle Left of RH Door Front	•	•	•					
Door on RH Side (RH Unit) 48.5	Middle Left of Door Front	N, W	•	•					
Door on LH Side (LH Unit) 48.5	Middle Right of Door Front	N, W	•		•				
Door on RH Side (RH Unit) 57.5/65.5/73.5	Middle Left of Door Front	•	N, W	•					
Door on LH Side (LH Unit) 57.5/65.5/73.5	Middle Right of Door Front	•	N, W		•				
Door on RH Side (RH Unit) 81.5	Middle Left of Door Front	•	•	•					
Door on LH Side (LH Unit) 81.5	Middle Right of Door Front	•	•		•				
Be_Hold Credenza Units									
Box/File & Box/Box/File	Upper Right of Top Drawer	•			•				
File/File	Upper Right of Top Drawer	•			•				
Be_Hold Sliding Credenza Units									
1.5H, 2H, & 3H, Sliding Door Units	not available								
Be_Hold Overhead Storage Units									
Hinged Doors	Lower Left of RH Door Front		•	•					
Sliding Doors	not available								
Be_Hold Stack Storage Cabinet									
Double Door	Bottom Left of RH Door Front		•	•					
Door on LH Side (LH Unit)	Bottom Right of Door Front		•		•				
Door on RH Side (RH Unit)	Bottom Left of Door Front		•	•					
Be_Hold Personal Storage Tower									
3H Storage Door on RH Unit	Upper LH of Storage Door Front	N, W			•				
4H, 5H, & 6H Storage Door on RH Unit	Upper LH of Storage Door Front	•			•				
3H Storage Door on LH Unit	Upper RH of Storage Door Front	N, W		•					
4H, 5H, & 6H Storage Door on LH Unit	Upper RH of Storage Door Front	•		•					
Ped Drawer Box/Box/File	Upper Right of Top Drawer	•			Q, W				
Ped Drawer File/File	Upper Right of Top Drawer	•			•				
Be_Hold Personal Storage Tower w/Valet Door									
3H Valet Door on LH Side	Upper RH of Valet Door Front	N, W			•				
4H, 5H, & 6H Valet Door on LH Side	Upper RH of Valet Door Front	•			•				
3H Valet Door on RH Side	Upper LH of Valet Door Front	N, W		•					

Pull Options	
6	Patterns
7	Crescent
8	Linear
9	Classic

Pull Options	
F	Wood Finger Pull
K	Aluminum J-Pull
Q	Blade
W	Wing
N	No Pull

Lock Programs

Digital Lock Applications

	Lock Location	HUDR-T180 Knob Top	HUDR-B180 Knob Bottom	HUDR-L180 Knob Left	HUDR-R180 Knob Right	HUDR-T090 Knob Top	HUDR-B090 Knob Bottom	HUDR-L090 Knob Left	HUDR-R090 Knob Right
Be Hold Personal Storage Tower w/Valet Door (cont')									
4H, 5H, & 6H Valet Door on RH Side	Upper LH of Valet Door Front	•		•					
Ped Drawer Box/Box/File	Upper Right of Top Drawer	•			Q, W				
Ped Drawer File/File	Upper Right of Top Drawer	•			•				
Be Hold Wardrobe									
Door on RH Unit 41.5	Upper LH of Door Front	N, W		•					
Door on LH Unit 41.5	Upper RH of Door Front	N, W			•				
Door on RH Unit 48.5	Mid LH of Door Front	N, W	•	•					
Door on LH Unit 48.5	Mid RH of Door Front	N, W	•		•				
Door on RH Unit 57.5/65.5	Mid LH of Door Front	•	N, W	•					
Door on LH Unit 57.5/65.5	Mid RH of Door Front	•	N, W		•				
Shared Storage Wardrobe RH Door 41.5	Upper LH of Door Front	N, W		•					
Shared Storage Wardrobe LH Door 41.5	Upper RH of Door Front	N, W			•				
Shared Storage Wardrobe RH Door 48.5	Mid LH of Door Front	N, W	•	•					
Shared Storage Wardrobe LH Door 48.5	Mid RH of Door Front	N, W	•		•				
Shared Storage Wardrobe RH Door 57.5/65.5	Mid LH of Door Front	•	N, W	•					
Shared Storage Wardrobe LH Door 57.5/65.5	Mid RH of Door Front	•	N, W		•				
Belong									
Security Drawer	Drawer Front				•				•
Beside Pantry									
Pantry Door, Left Side	Top Right	•						•	
Pantry Door, Right Side	Top Left	•							•
Compose Storage Lower Storage-Mobile Pedestals									
1.5H (Box/File)	Top Right	6, 7, 8, 9			6, 7, 8				
2H (Box/Box/File & File/File)	Top Right	6, 7, 8, 9			6, 7, 8				
Compose Pedestal									
1H (Box/Box)	Top Right	6, 7, 8, 9			6, 7, 8				
1.5H (Box/File)	Top Right	6, 7, 8, 9			6, 7, 8				
2H (Box/Box/File & File/File)	Top Right	6, 7, 8, 9			6, 7, 8				
Compose Lateral Files									
1H	Top Right					6, 7, 8, 9			6, 7, 8, 9
1.5H	Top Right	6, 7, 8, 9			6, 7, 8, 9				
2H	Top Right	6, 7, 8, 9			6, 7, 8, 9				
3H	Top Right	6, 7, 8, 9			6, 7, 8, 9				
Compose Open Shelf Lateral Files									
1.5H	Top Right					6, 7, 8, 9			6, 7, 8, 9
2H	Top Right					6, 7, 8, 9			6, 7, 8, 9

Note: Digital locks are not compatible with the Aluminum J Pull (K) on Compose.

Pull Options	
6	Patterns
7	Crescent
8	Linear
9	Classic

Pull Options	
F	Wood Finger Pull
K	Aluminum J-Pull
Q	Blade
W	Wing
N	No Pull

Lock Programs

Digital Lock Applications

	Lock Location	HUDR-T180 Knob Top	HUDR-B180 Knob Bottom	HUDR-L180 Knob Left	HUDR-R180 Knob Right	HUDR-T090 Knob Top	HUDR-B090 Knob Bottom	HUDR-L090 Knob Left	HUDR-R090 Knob Right
Compose Combination Units									
2H Left-Hand	Top Right	6, 7, 8, 9			6, 7, 8, 9				
2H Right-Hand	Top Right	6, 7, 8, 9			6, 7, 8, 9				
Compose Storage Units w/Doors									
1H	Top Left Corner of Right Door	6, 7, 8, 9		6, 7, 8, 9					
2H	Top Left Corner of Right Door	6, 7, 8, 9		6, 7, 8, 9					
3H	Top Left Corner of Right Door	6, 7, 8, 9		6, 7, 8, 9					
Compose Personal Storage Tower w/Side Bookcase									
Right-Hand	Top Right of BBF	6, 7, 8, 9			6, 7, 8				
Left-Hand	Top Right of BBF	6, 7, 8, 9			6, 7, 8				
Compose Personal Storage Tower w/Wardrobe — One Unit									
RH Wardrobe - Wardrobe Door	Left Edge of Door	6, 7, 8, 9	6, 7, 8, 9	6, 7, 8, 9					
RH Wardrobe - Storage Door	Bottom Right Corner of Door		6, 7, 8, 9		6, 7, 8, 9				
RH Wardrobe - BBF	Top Right of BBF	6, 7, 8, 9			6, 7, 8				
LH Wardrobe - Wardrobe Door	Right Edge of Door	6, 7, 8, 9	6, 7, 8, 9		6, 7, 8, 9				
LH Wardrobe - Storage Door	Bottom Left Corner of Door		6, 7, 8, 9	6, 7, 8, 9					
LH Wardrobe - BBF	Top Right of BBF	6, 7, 8, 9			6, 7, 8				
Compose Wardrobes									
Wardrobe - Right		6, 7, 8, 9	6, 7, 8, 9	6, 7, 8, 9					
Wardrobe - Left		6, 7, 8, 9	6, 7, 8, 9		6, 7, 8, 9				
Compose Full Height Doors Stack-on Storage									
1H Base Unit	Lower Left Corner of Right Door		6, 7, 8, 9	6, 7, 8, 9					
2H Base Unit	Lower Left Corner of Right Door		6, 7, 8, 9	6, 7, 8, 9					
Compose Partial Height Doors Stack-On Storage									
1H Base Unit	Lower Left Corner of Right Door		6, 7, 8, 9	6, 7, 8, 9					
2H Base Unit	Lower Left Corner of Right Door		6, 7, 8, 9	6, 7, 8, 9					
Masters Lower Storage Pedestals & Attached Lateral Files									
Attached Pedestal (Box/Box/File & File/File)	Upper Right Drawer Front	.			.				
Mobile Pedestal (Box/File)	Upper Right Drawer Front	.			.				
Attached Lateral File (1H, 1.5H & 2H)	Upper Right Drawer Front	.			.				
Masters Freestanding Lateral Files (3H, 4H, 5H & 6H)									
Freestanding Lateral File (Drawer 3H, 4H, 5H & 6H)	Upper Right Drawer Front (2nd Drawer from Bottom)	.			.				
Freestanding Lateral File (Upper Doors 5H & 6H only)	Lower Left of RH Door Front		.	.					

Note: Digital locks are not compatible with the Aluminum J Pull (K) on Compose.

Pull Options	
6	Patterns
7	Crescent
8	Linear
9	Classic

Pull Options	
F	Wood Finger Pull
K	Aluminum J-Pull
Q	Blade
W	Wing
N	No Pull

Lock Programs

Digital Lock Applications

	Lock Location	HUDR-T180 Knob Top	HUDR-B180 Knob Bottom	HUDR-L180 Knob Left	HUDR-R180 Knob Right	HUDR-T090 Knob Top	HUDR-B090 Knob Bottom	HUDR-L090 Knob Left	HUDR-R090 Knob Right
Masters Lower 2-door Storage									
2H Lower Storage	Upper Left of RH Door Front	•		•					
3H Lower Storage	Middle Left of RH Door Front	•	•	•					
Masters Combination Units									
Doors	Lower Left of RH Door Front		•	•					
Drawers	Upper Right of Top Drawer Front	•			•				
Masters Wardrobe with Open Storage									
Door on LH Side (LH Unit)	Lower Mid RH of Door Front	•	•		•				
Door on RH Side (RH Unit)	Lower Mid LH of Door Front	•	•	•					
Masters Wardrobe with Closed Storage									
2-Door Unit	Lower Mid of RH Door Front	•	•	•					
Masters Personal Storage Tower with F/F & V									
Valet Door on LH Side	Lower Mid RH of Door Front	•	•		•				
Storage Door on RH Side	Lower LH of Door Front		•	•					
Valet Door on RH Side	Middle Left of Door Front	•	•	•					
Storage Door on LH Side	Lower RH of Door Front		•		•				
Ped Drawer (The Same Regardless of LH or RH Unit)	Upper Right of Middle Drawer	•			•				
Masters Personal Storage Tower with F/F & Valet									
Valet Door on LH Side	Middle Right of Door Front	•	•		•				
Storage Door on RH Side	Lower LH of Door Front		•	•					
Valet Door on RH Side	Middle Left of Door Front	•	•	•					
Storage Door on LH Side	Lower RH of Door Front		•		•				
Ped Drawer (The Same Regardless of LH or RH Unit)	Upper Right of Top Drawer	•			•				
Masters Storage Tower									
Storage Door on RH Unit	Lower LH of Door Front		•	•					
Storage Door on LH Unit	Lower RH of Door Front		•		•				
Ped Drawer (The Same Regardless of LH or RH Unit)	Upper Right of Top Drawer	•			•				
Masters Freestanding Wardrobe Tower									
Door on RH Unit	Lower Mid LH of Door Front	•	•	•					
Door on LH Unit	Lower Mid RH of Door Front	•	•		•				
Masters Credenza Units									
Pedestals or Lateral Files	Upper Right of Top Drawer	•			•				
Closed Storage Units	Upper Left of RH Door Front	•		•					
Masters Upper Storage									
Vertical Storage Units	Lower Left of RH Door Front		•	•					
Overhead Storage Units	Lower Left of RH Door Front		•	•					

Pull Options	
6	Patterns
7	Crescent
8	Linear
9	Classic

Pull Options	
F	Wood Finger Pull
K	Aluminum J-Pull
Q	Blade
W	Wing
N	No Pull

Lock Programs

Digital Lock Applications

	Lock Location	HUDR-T180 Knob Top	HUDR-B180 Knob Bottom	HUDR-L180 Knob Left	HUDR-R180 Knob Right	HUDR-T090 Knob Top	HUDR-B090 Knob Bottom	HUDR-L090 Knob Left	HUDR-R090 Knob Right
X Series									
Attached, Suspended, Mobile Pedestals	Lockbar, Right-Hand				.				
	Lockbar, Left-Hand (individually locking only)			.					
Personal Storage Tower (2H and 3H only)	Top of Tower			.	.				
Personal Storage Tower Pedestal Section	Lockbar, Right-Hand				.				
	Lockbar, Left-Hand (individually locking only)			.					
Personal Storage Tower Valet Section	Valet Door, Right-Hand	.	.	.					
	Valet Door, Left-Hand	.	.		.				
Personal Storage Tower Storage Unit Section	Storage Door, Left-Hand	.	.		.				
	Storage Door, Right-Hand	.	.	.					
Locker, Group Locker, Cubby Locker	Left-Hand Door	.	.		.				
	Right-Hand Door	.	.	.					
Lateral File	Top of File			.	.				
	Drawer Front	.		.	.				
Combination Unit Drawer Section	Top of Unit			.	.				
Combination Unit Storage Unit Section	Storage Door, Left-Hand	.	.		.				
	Storage Door, Right-Hand	.	.	.					
Combination Unit Valet Section	Valet Door, Left-Hand	.	.		.				
	Valet Door, Right-Hand	.	.	.					
Storage Cabinet and Wardrobe	Top of Cabinet			.	.				
	Right-Hand Door	.	.	.					

Pull Options	
6	Patterns
7	Crescent
8	Linear
9	Classic

Pull Options	
F	Wood Finger Pull
K	Aluminum J-Pull
Q	Blade
W	Wing
N	No Pull

Lock Programs

Service Parts

Service Parts

Service parts for the SL, ML and MLP are available through www.EasyKeys.com; Haworth will not be supplying these products directly.

To order products, dealers must set up an account with Easy Keys.

Easy Key is offering discounts to Haworth dealers. To set-up an account, use the link provided on My Haworth - search Easy Keys.

After the account is set up, dealers can order product at the negotiated rate. For future orders, dealers can go directly to www.EasyKeys.com and log in. In order to receive the discounted pricing, dealers must log in with the username and password that was created while setting up the account.

Finish/Color Legend

Trim Grade A

Smooth

TR-R	Beige
TR-AK	Chalk
TR-K	Charcoal
TR-C1	Cocoa
TR-J	Graphite
TR-G	Gray Tone
TR-AA	Putty
TR-E	Smoke
TR-PLS	Smooth Plaster
TR-FM	Snow

Textured

TR-TG	Grout
TR-TF	Pitch
TR-TW	Plaster

Transluents

TR-LQ	Frost
TR-LX	Ice
TR-LY	Moon
TR-LU	Shadow

Grade B

Smooth

TR-1C	Accent Blue
TR-1G	Blue Jay
TR-1R	Brownstone
TR-1N	Night
TR-1Q	Park
TR-RR	Rusty Red
TR-1M	Sable
TR-1J	Sky Blue

Smooth Metallic

TR-MC	Metallic Champagne
TR-MG	Metallic Gunmetal
TR-LE	Metallic Silver

Textured Metallic

TR-HE	Hellenic
-------	----------

Lock Plugs

LR-BL	Black
LR-BP	Chrome

Laminate Grade A

Solid Color

H-34	Beige
H-AK	Chalk
H-8J	Charcoal
H-3J	Graphite
H-62	Gray Tone
H-WL	Linen
H-3P	Platinum
H-AA	Putty
H-3E	Smoke

Patterned

H-P1	Linen Casual
H-P2	Linen Classic
H-P3	Linen Crisp
H-P4	Linen Flax

Wood Grain

H-AE	Maple
------	-------

Grade B

Premium Wood Grain

H-KA	Brazilwood
H-KG	Columbian Walnut
H-KP	Field Elm
H-KN	Grey Elm
H-KM	Landmark Wood
H-KL	Neo Walnut
H-KC	New Age Oak
H-KR	Phantom Ecu
H-KS	Phantom Pearl
H-KD	River Cherry
H-KF	Williamsburg Cherry

Edgeband

Solid Color

HP-34	Beige
HP-AK	Chalk
HP-8J	Charcoal
HP-3J	Graphite
HP-62	Gray Tone
HP-WL	Linen
HP-3P	Platinum
HP-AA	Putty
HP-3E	Smoke

Patterned Edgeband

HP-P1	Linen Casual
HP-P2	Linen Classic
HP-P3	Linen Crisp
HP-P4	Linen Flax

Wood Grain

HP-KA	Brazilwood
HP-KG	Columbian Walnut
HP-KP	Field Elm
HP-KN	Grey Elm
HP-KM	Landmark Wood
HP-AE	Maple
HP-KL	Neo Walnut
HP-KC	New Age Oak
HP-KR	Phantom Ecu
HP-KS	Phantom Pearl
HP-KD	River Cherry
HP-KF	Williamsburg Cherry

Planked Wood

VH-W35	Walnut
VB-W35	White Oak

Painted MDF

PW-R	Beige
PW-F	Black
PW-AK	Chalk
PW-G	Gray Tone
PW-PL	Polar
PW-RR	Rusty Red
PW-1J	Sky Blue
PW-SP	Sparrow
PW-SY	Stormy
PW-ST	Straw
PW-1H	Terra
PW-VA	Vapor

ALERT: These materials are current, however they are being considered for future obsolescence due to low volume.

Trims:

TR-1E	Accent Orange
TR-1F	Accent Red
TR-AR	Argent
TR-CTS	Chartreuse
TR-DM	Dark Bronze Metallic
TR-1H	Terra
TR-1K	Wren

Laminate:

H-AM	Amber Cherry
H-AD	Medium Cherry

Edgeband:

HP-AM	Amber Cherry
HP-AD	Medium Cherry

Forest Stewardship Council® (FSC®) Statement: In our continuing support of sustainable forestry and responsible purchasing, Haworth North America is offering FSC certified wood products at no up-charge. By providing FSC certified material, Haworth is supporting our client's green building goals and demonstrating our collective commitment to source materials more sustainably.

Haworth will provide to you the necessary FSC-certified paperwork with your shipment. For more information, FAQs, and a complete FSC product list (including product exceptions), go to the Library and search FSC.

Haworth FSC Trademark License
#FSC-C002821

Fabrics/Color Legend

Seating Fabrics

Grade A

Blanket (4H)
Morse (4J)
Pixel (2A)
Tellure (3A)

Grade B

Diagonale (4N)
Element (4Z)
Floyd by Kvadrat (S6)
Kaleidoscope (S4)
Ramie (4V)
Reflect by Kvadrat (S8)
Squares (RA)
Tech (MV)

Grade C

Dots (6K)
Oceanic (4T)

Grade D

Atlas by Kvadrat (LW)
Big Arrow (4D)
Big Diagonale (1K)
Clara 2 by Kvadrat (NV)
Cotswold (JB)
Main Line Flax (6M)
Melange Nap by Kvadrat (S7)
Recheck by Kvadrat (RP)

Grade E

Steelcut Trio 3 by Kvadrat (SY)

Grade F

Divina Melange 3 by Kvadrat (SV)
Hallindal 65 by Kvadrat (SZ)

* For most current finish and fabric availability please reference surfaces.haworth.com.

ALERT: These materials are current, however they are being considered for future obsolescence due to low volume.

Seating Fabrics

Grade A

Twist (MM)

Grade B

Gauge (1X)

Grade D

Tangram (LV)

Haworth+

For information on the Haworth+ alliance program, including images and product availability, please refer to:
Haworth.com > Surface Collection > Haworth+ Library

Customer's Own Material (COM)

For general Customer's Own Material (COM) information including processes and forms, please refer to:
Haworth.com > Surface Collection > Resources > COM
For information on approved COM's, please refer to:
Haworth.com > Surface Collection > COM Library

Index

Products are listed alphabetically in this index by alpha-numeric prefix/suffix codes.

Product Code	Product Description	Page
169BK	Ergotron Keyboard Tray – Keyboard Tray with Mouse Pad	116
24-205-214	Ergotron Neo-Flex Laptop Cart – Ergotron Neo-Flex Laptop Cart	153
24-214-085	Ergotron WorkFit-C – Single Monitor	136
24-215-085	Ergotron WorkFit-C – Single Monitor	136
24-216-085	Ergotron WorkFit-C – Single Monitor	136
24-220-055	Ergotron Teachwell® Mobile Digital Workspace	154
24-316-026	Ergotron WorkFit-A — Dual Attached Sit-Stand Workstation	135
24-317-026	Ergotron WorkFit-A — Single Attached Sit-Stand Workstation	134
24-390-026	Ergotron WorkFit-A — Single Attached Sit-Stand Workstation	134
24-391-026	Ergotron WorkFit-A — Single Attached Sit-Stand Workstation	134
24-392-026	Ergotron WorkFit-A — Dual Attached Sit-Stand Workstation	135
24-481-003	Ergotron LearnFit – LearnFit Desk	155
24-547-003	Ergotron LearnFit – LearnFit Desk	155
33-341-200	Ergotron WorkFit-S — Dual Attached Sit-Stand Workstation	140
33-349-200	Ergotron WorkFit-S — Dual Attached Sit-Stand Workstation	140
33-349-211	Ergotron WorkFit-S — Dual Attached Sit-Stand Workstation	140
33-350-200	Ergotron WorkFit-S — Single Attached Sit-Stand Workstation	139
33-351-200	Ergotron WorkFit-S — Single Attached Sit-Stand Workstation	139
33-397-062	Ergotron WorkFit-T — Desktop Sit-Stand Workstation	142
33-397-085	Ergotron WorkFit-T — Desktop Sit-Stand Workstation	142
33-406-062	Ergotron WorkFit-TL — Desktop Sit-Stand Workstation	143
33-406-085	Ergotron WorkFit-TL — Desktop Sit-Stand Workstation	143
33-407-062	Ergotron WorkFit-SR — Dual Attached Sit-Stand Workstation	141
33-407-085	Ergotron WorkFit-SR — Dual Attached Sit-Stand Workstation	141
33-418-085	Ergotron WorkFit-TL — Desktop Sit-Stand Workstation	143
33-458-917	Ergotron WorkFit-Z Mini — Sit-Stand Desk Converter	145
33-467-921	Ergotron WorkFit-TX — Standing Desk Converter	144
33-468-921	Ergotron WorkFit Corner — Standing Desk Converter	137
45-214-026	Ergotron Monitor Arms – Desk Mount - Single Arm	127
45-228-026	Ergotron Monitor Arms – Wall Mount - Heavy Duty	127
45-241	Ergotron Monitor Arms – Single Arm	120
45-245	Ergotron Monitor Arms – Dual Arm	120
45-248	Ergotron Monitor Arms – Dual Arm	120
45-289-026	Ergotron Monitor Arm Accessories – LX Extension	125
45-295	Ergotron Monitor Arms – Single Arm	120
45-360-026	Ergotron Monitor Arm – Single Arm	122
45-362-026	Ergotron Monitor Arm Accessories – LX Sit-to-Stand Extension	125
45-384-026	Ergotron Monitor Arm – Single Arm	122
45-405-026	Ergotron WorkFit-LX — Sit-Stand Desk Mount System	138
45-475	Ergotron Monitor Arms – Single Arm	118
45-476	Ergotron Monitor Arms – Dual Arm	118
45-478	Ergotron Monitor Arms – Single Arm	118
45-479	Ergotron Monitor Arms – Dual Arm	118
45-486	Ergotron Monitor Arm – Single Arm	126
45-489	Ergotron Monitor Arm – Dual Direct Arm	123
45-490	Ergotron Monitor Arms – Single Arm	120
45-491	Ergotron Monitor Arms – Dual Arm	120
45-492	Ergotron Monitor Arms – Dual Arm	120
45-496	Ergotron Monitor Arm – Dual Arm	126
45-509-216	Ergotron Monitor Arm – LX Dual Stacking Arm - Tall Pole Monitor Arm	121
45-537	Ergotron Monitor Arms – Single Arm	120

Index

<u>Product Code</u>	<u>Product Description</u>	<u>Page</u>
45-549-026	Ergotron Monitor Arm – LX Dual Stacking Arm - Tall Pole Monitor Arm	121
45-625	Ergotron Monitor Arm – Single Arm	126
45-626	Ergotron Monitor Arms – Single Arm	120
45-627	Ergotron Monitor Arm – Dual Direct Arm	123
47-109-224	Ergotron Monitor Mount Accessories – Single Conversion Kit	133
47-110-224	Ergotron Monitor Mount Accessories – Dual Conversion Kit	133
4TJC-72	Wire Management – J-Channel	185
60-589-060	Ergotron Monitor Arm Accessories – Monitor Quick Release LCD Bracket	128
7031-7001	Information Display – Markerboard Accessories	159
7031-7002	Information Display – Markerboard Accessories	159
7062-8001	Information Display – Markerboard Accessories	159
80-063	Ergotron CPU Holder – Small CPU Holder	117
80-105-064	Ergotron CPU Holder – Cable CPU Holder	117
97-468	Ergotron CPU Holder – Universal CPU Holder	117
97-558-200	Ergotron WorkFit — Accessories – Tablet/Document Holder	147
97-581-019	Ergotron WorkFit — Accessories – Worksurface	147
97-582-009	Ergotron Keyboard Tray – Neo-Flex Keyboard Tray	116
97-606	Ergotron WorkFit — Accessories – Conversion Kit Single HD to Dual	146
97-615	Ergotron WorkFit — Accessories – Tall-User Kit for WorkFit Dual	148
97-616	Ergotron WorkFit — Accessories – Conversion Kit: LCD & Laptop to Dual	148
97-617	Ergotron WorkFit — Accessories – Conversion Kit: Dual to LCD & Laptop	148
97-620-060	Ergotron WorkFit — Anti-Fatigue Floor Mat – Ergotron WorkFit — Anti-Fatigue Floor Mat	152
97-653	Ergotron WorkFit — Accessories – Large Keyboard Tray	147
97-692	Ergotron WorkFit — Accessories – Grommet Mount	146
97-774-003	Ergotron Monitor Arm Accessories – LX One-Stop Rotational Control Kit	124
97-783	Ergotron Monitor Arm – Dual Monitor and Handle Kit	128
97-844	Ergotron Monitor Arm Accessories – LX Pole Collar	125
97-845	Ergotron Monitor Arm Accessories – Tall-User Kit for Single Display	151
97-897	Ergotron WorkFit — Accessories – Deep Keyboard Tray	149
97-898	Ergotron WorkFit — Accessories – Corner Keyboard Tray	149
97-926-064	Ergotron LearnFit – Storage Bin	155
97-933	Ergotron WorkFit — Accessories – WorkFit LCD & Laptop Kit	150
97-934	Ergotron WorkFit — Accessories – WorkFit Dual Monitor Kit	150
97-935	Ergotron WorkFit — Accessories – WorkFit Single LCD Monitor Kit	150
97-940-026	Ergotron Monitor Arm Accessories – LX Arm, Extension and Collar Kit	125
98-009-026	Ergotron Monitor Arms – HX Triple Monitor Bow Kit	119
98-009-216	Ergotron Monitor Arms – HX Triple Monitor Bow Kit	119
98-017	Ergotron Monitor Arm Accessories – Grommet Mount for LX Arm on WorkFit-T/TL	129
98-034	Ergotron Monitor Arm Accessories – Grommet Mount for LX Single and Dual Direct Arms	129
98-035	Ergotron Monitor Arm Accessories – Grommet Mount for LX Dual Arm	129
98-037-062	Ergotron Monitor Arm – Dual Direct Handle Kit	123
98-060-003	Ergotron Monitor Arm Accessories – LX Two-Stop Rotational Control Kit	124
98-101-009	Ergotron Monitor Arm Accessories – Dual Monitor Double-Hinged Bow	151
98-110	Ergotron Monitor Arm Accessories – Grommet Mount for MXV Single Monitor Arm	129
98-111	Ergotron Monitor Arm Accessories – Grommet Mount for MXV Dual Monitor Arm	129
98-130-216	Ergotron Monitor Arm Accessories – LX Arm, Extension and Collar Kit	125
98-477	Ergotron Monitor Arm Accessories – Top Mount Low Profile C-Clamp	130
98-478	Ergotron Monitor Arm Accessories – Top Mount Low Profile C-Clamp	130
AAOD-S	Storage – Magnetic Divider	182
AAOO-S	Storage – Personal Storage Hook	181
AAOP-S	Storage – File Partition	182
AAOT-S	Storage – Drawer Tray	182
AHDD-SU	Storage – Security Drawer	181

Index

Product Code	Product Description	Page
AKWN	Wire Management – Height Adjustable Table - Belong Horizontal	187
ALDD-F	Storage – Drawer Liner	181
ALTD-S	Storage – Top Liner — Security Drawer	181
CH-8	Workstation Accessories – UniGroup All-Purpose Hook	208
CK-3	Lock Programs – HW Control Key	214
DM12-1006-1	Ergotron Zip 12 Charging – Ergotron Zip 12 Charging	156
DMSP	Work Tools – Mini Shelf	204
DS-3	Workstation Accessories – Shallow Drawer	207
DTLT-2	Work Tools – Letter Tray	205
DTPR-3	Work Tools – Paper Sorter	204
DTPT-3	Work Tools – Phone Shelf	204
DTRB	Work Tools – Waste Bin	205
DTSB-3	Work Tools – Binder Bin	204
E2CH-8	Workstation Accessories – UniGroup Too All Purpose Hook	208
EAAW-0000-H	Wire Management – Cable Chain	184
EUAC	Electrical Components – Cord Management Cuff	25
EUAM-0000	Wire Management – Conduit Clamp	185
EUAW	Electrical Components – Mesh Cord Manager with Cuffs	25
EUAW-4000-V	Wire Management – Compose Connections Cable Chain	184
EUAW-NH	Wire Management – Wire Manager — Horizontal	186
EUB1-HLOB-2100	Electrical Components – Flush Mounted Power — Hardwire	103
EUB1-HLOB-2110	Electrical Components – Flush Mounted Power — Hardwire	103
EUB1-HLOB-2112	Electrical Components – Flush Mounted Power — Hardwire	103
EUB1-PL0B-2100	Electrical Components – Flush Mounted Power — Corded	99
EUB1-PL0B-2110	Electrical Components – Flush Mounted Power — Corded	99
EUB1-PL0B-2112	Electrical Components – Flush Mounted Power — Corded	99
EUB1-PL0B-4000	Electrical Components – Flush Mounted Power — Corded	99
EUB1-SF0B-2100	Electrical Components – Flush Mounted Power — Spiral Cord for Height Adjustable	107
EUB1-SF0B-2110	Electrical Components – Flush Mounted Power — Spiral Cord for Height Adjustable	107
EUB1-SF0B-2112	Electrical Components – Flush Mounted Power — Spiral Cord for Height Adjustable	107
EUB1-SF0B-4000	Electrical Components – Flush Mounted Power — Spiral Cord for Height Adjustable	107
EUB1-SL0B-2100	Electrical Components – Flush Mounted Power — Cord for Height Adjustable	111
EUB1-SL0B-2110	Electrical Components – Flush Mounted Power — Cord for Height Adjustable	111
EUB1-SL0B-2112	Electrical Components – Flush Mounted Power — Cord for Height Adjustable	111
EUB1-SL0B-4000	Electrical Components – Flush Mounted Power — Cord for Height Adjustable	111
EUB5	Electrical Components – Power Suite	21
EUC1-HF0P-200000	Electrical Components – Power, Data and USB	65
EUC1-HF0P-210010	Electrical Components – Power, Data and USB	65
EUC1-HF0P-311010	Electrical Components – Power, Data and USB	65
EUC1-PF0P-200000	Electrical Components – Power, Data and USB	57
EUC1-PF0P-210010	Electrical Components – Power, Data and USB	57
EUC1-PF0P-311010	Electrical Components – Power, Data and USB	57
EUC1-PF0P-400000	Electrical Components – Power, Data and USB	57
EUC2-HF0P-210010	Electrical Components – Power, Data and USB	69
EUC2-HF0P-311010	Electrical Components – Power, Data and USB	69
EUC2-PF0P-210010	Electrical Components – Power, Data and USB	61
EUC2-PF0P-311010	Electrical Components – Power, Data and USB	61
EUC2-PF0P-400000	Electrical Components – Power, Data and USB	61
EUC4	Electrical Components – Power Cube	21
EUCB-TJP	Electrical Components – Belong Power Cube 65W and Belong Power Suite 65W	24
EUCB-WFP	Electrical Components – Belong Power Cube 65W and Belong Power Suite 65W	24
EUCB-WJP	Electrical Components – Belong Power Cube 65W and Belong Power Suite 65W	24
EUCN-PJ	Electrical Components – Collaborative Power Station	35

Index

<u>Product Code</u>	<u>Product Description</u>	<u>Page</u>
EUD1-HF0B-2010	Electrical Components – Enhanced Power Module — Hardwire	.47
EUD1-HF0B-2110	Electrical Components – Enhanced Power Module — Hardwire	.47
EUD1-HF0B-2112	Electrical Components – Enhanced Power Module — Hardwire	.47
EUD1-PF0B-2010	Electrical Components – Enhanced Power Module — Corded	.41
EUD1-PF0B-2110	Electrical Components – Enhanced Power Module — Corded	.41
EUD1-PF0B-2112	Electrical Components – Enhanced Power Module — Corded	.41
EUD1-PF0B-4000	Electrical Components – Enhanced Power Module — Corded	.41
EUD1-SF0B-2110	Electrical Components – Enhanced Power Module — Spiral Corded — Height Adjustable	.52
EUD1-SF0B-4000	Electrical Components – Enhanced Power Module — Spiral Corded — Height Adjustable	.52
EUD1-SL0B-2110	Electrical Components – Enhanced Power Module — Cord for Height Adjustable	.53
EUD1-SL0B-4000	Electrical Components – Enhanced Power Module — Cord for Height Adjustable	.53
EUIDB-0000-H	Electrical Components – Above Worksurface – Adjustable	.54
EUIDB-0000-N	Electrical Components – Above Worksurface – Adjustable	.54
EUIDB-0000-T	Electrical Components – Above Worksurface – Adjustable with Tackboard Offset	.55
EUIDB-0000-U	Electrical Components – Under Worksurface – Fixed	.55
EUIDB-0000-W	Electrical Components – Above Worksurface – Fixed	.55
EUIDB-J	Electrical Components – For Use with X Series	.56
EUDX-3000-B	Electrical Components – Cables	.32
EUDX-H000-B	Electrical Components – Cables	.32
EUDX-U000-B	Electrical Components – Retrofit USB Charging Cable	.32
EUDX-V000-B	Electrical Components – Cables	.32
EUE1-000B	Electrical Components – Flip Top Unit — Non-Powered	.74
EUE1-1111W	Electrical Components – Power and Data	.73
EUE1-1331W	Electrical Components – Power and Data	.73
EUE1-1B01W	Electrical Components – Power and Data	.73
EUE1-C331W	Electrical Components – Power and Data	.73
EUE1-HF0B-1212	Electrical Components – Power, Data and USB	.87
EUE1-HF0B-2110	Electrical Components – Power, Data and USB	.87
EUE1-PF0B-1212	Electrical Components – Power, Data and USB	.75
EUE1-PF0B-2110	Electrical Components – Power, Data and USB	.75
EUE1-PF0B-4000	Electrical Components – Power, Data and USB	.75
EUE2-000B	Electrical Components – Flip Top Unit — Non-Powered	.74
EUE2-1331W	Electrical Components – Power and Data	.73
EUE2-C331W	Electrical Components – Power and Data	.73
EUE2-HF0B-1212	Electrical Components – Power, Data and USB	.93
EUE2-HF0B-2110	Electrical Components – Power, Data and USB	.93
EUE2-PF0B-1212	Electrical Components – Power, Data and USB	.81
EUE2-PF0B-2110	Electrical Components – Power, Data and USB	.81
EUE2-PF0B-4000	Electrical Components – Power, Data and USB	.81
EUET-0000-1M3N	Electrical Components – Power Tap — Corded Horizontal and Vertical	.28
EUET-0030-2M3N	Electrical Components – Power Tap — Horizontal	.26
EUET-0030-2M3N	Electrical Components – Power Tap — Vertical	.27
EUET-0030-3M3N	Electrical Components – Power Tap — Horizontal	.26
EUET-0030-3M3N	Electrical Components – Power Tap — Vertical	.27
EUET-0030-4M3N	Electrical Components – Power Tap — Horizontal	.26
EUET-0030-4M3N	Electrical Components – Power Tap — Vertical	.27
EUET-0030-CM3N	Electrical Components – Power Tap — Hardwire	.28
EUF1	Electrical Components – Classic Power Module	.33
EUFB-0000-AB	Electrical Components – Classic Power Module Bracket - Angled	.34
EUFB-0000-SB	Electrical Components – Classic Power Module Bracket - Vertical Bracket	.34
EUFB-0000-UB	Electrical Components – Classic Power Module Bracket - Under Surface	.34
EUG1	Grommets – Flip Top Unit — Hatch	.158
EUP1-HF	Electrical Components – Flush Mounted — Round	.114

Index

<u>Product Code</u>	<u>Product Description</u>	<u>Page</u>
EUP1-PF	Electrical Components – Flush Mounted — Round	114
EUR1	Electrical Components – Plug Strip	21
EURT-0000-N001CB	Electrical Components – Data Bezel	31
EURT-0000-N001CW	Electrical Components – Data Bezel	31
EURT-0000-N001SB	Electrical Components – Data Bezel	31
EURT-0000-N001SW	Electrical Components – Data Bezel	31
EURT-0072-1010	Electrical Components – Bezel Utility Module	31
EURT-0072-1100	Electrical Components – Bezel Utility Module	31
EUS1-HLOB	Electrical Components – Enhanced Power Module — Seamless	37
EUS1-HLOW	Electrical Components – Enhanced Power Module — Seamless	37
EUS1-PF0B	Electrical Components – Enhanced Power Module — Seamless	37
EUS1-PF0W	Electrical Components – Enhanced Power Module — Seamless	37
EUUB-UP	Electrical Components – Belong Power Cube 65W and Belong Power Suite 65W	24
EUWC-HLOB	Electrical Components – Wireless Charging Module	115
EUWC-HLOW	Electrical Components – Wireless Charging Module	115
EUWC-PF0B	Electrical Components – Wireless Charging Module	115
EUWC-PF0W	Electrical Components – Wireless Charging Module	115
EUWT	Electrical Components – Wire Management Tray	23
HCH-0008	Workstation Accessories – PLACES All-Purpose Hook	208
HCPL-GFT1-13	Lighting — Haworth Collection – Table Light	168
HCPL-SLF1-47	Lighting — Haworth Collection – Floor Light	175
HCPL-SLSV-4BP	Lighting — Haworth Collection – Base Pads	175
HCPL-SLT1-17	Lighting — Haworth Collection – Table Light	175
HCPL-TTF1-60	Lighting — Haworth Collection – Floor Light	176
HCPL-TTT1-14	Lighting — Haworth Collection – Table Light	176
HCPL-TTT2-21	Lighting — Haworth Collection – Table Light	176
HCPL-UMT2-11	Lighting — Haworth Collection – Audio Lantern	177
HUDF-F	Lock Programs – Digital Lock Control Key Fob	215
HUDR-B	Lock Programs – Digital Lock	215
HUDR-L	Lock Programs – Digital Lock	215
HUDR-R	Lock Programs – Digital Lock	215
HUDR-T	Lock Programs – Digital Lock	215
HWKB-1	Lock Programs – HW Key Blank	214
HWMK-1	Lock Programs – HW Master Key	214
HWSK	Lock Programs – HW Replacement Keys	214
HW-SVC	Lock Programs – HW Plugs and Keys	214
JAC-18	Workstation Accessories – Pencil Drawer	207
JAG-1	Grommets	157
JAG-2	Grommets	157
JRPY-3948	Recycling Solutions – Recycling Solutions	178
KDV	Storage – Dividers	180
KJTY-10	Storage – Personal Tray	180
KJTY-12	Storage – PDA Tray	180
KJTY-9	Storage – Pencil Tray	180
KUAH-0002	Work Tools – Magnet Hooks	206
KUAH-0003	Work Tools – Magnet Hook	206
KUAK	Work Tools – Trays	200
KUAK	Work Tools – Accessory Kit	203
KUAM-0411	Work Tools – Magnet Board	206
KUAM-0518	Work Tools – Magnet Board	206
KUAP-0000	Work Tools – Round Peg Magnets	206
KUAR-0403	Work Tools – Mirror	206
KUBL-2030-FJ	Work Tools – Blotter	203

Index

<u>Product Code</u>	<u>Product Description</u>	<u>Page</u>
KUBT	Work Tools – Base Tray	201
KUCU-0915-BNN	Work Tools – Open C Cubby	200
KUCU-1215-BNS	Work Tools – Open C Cubby	200
KUDP-2420	Workstation Accessories – Pencil + Drawer	207
KUHS-0000-H	Work Tools – Hanging Sorter	202
KULS	Work Tools – Desk Top L-Screen	201
KUP1-0000-CSN	Work Tools — Mounting – Tool Rail — Single Post — C-Clamp or Thru-mount	192
KUP1-0000-USN	Work Tools — Mounting – Tool Rail — Single Post — L-Bracket Mount	194
KUP2-0000-UBI	Work Tools — Mounting – Tool Rail — Single Post Internal/Benching	198
KUPA	Storage – Suspended Pedestal	179
KUPD	Storage – Suspended Pedestal	179
KUPT-0913-F	Work Tools – Paper Tray — Landscape	202
KUPT-0913-H	Work Tools – Paper Tray — Landscape	202
KUPY	Work Tools — Mounting – Slat, Wall Mount	189
KUR1-0424-PZN	Work Tools — Mounting	190
KUR1-1224-CSN	Work Tools — Mounting – Tool Rail — Horizontal Surface Mount C-Clamp or Thru-Mount	191
KUR1-1224-USE	Work Tools — Mounting – Tool Rail — Single Sided Continuous Benching End	195
KUR1-1224-USI	Work Tools — Mounting – Tool Rail — Internal Single Sided Continuous Benching Application	197
KUR1-1224-USN	Work Tools — Mounting – Tool Rail — Under Horizontal Surface Mount — L-Bracket	193
KUR2-1224-UBE	Work Tools — Mounting – Tool Rail — Double-Sided Continuous Benching End Application Only	196
KUR2-1224-UBI	Work Tools — Mounting – Tool Rail — Internal Continuous Benching Application Only	198
KURB	Recycling Solutions – Recycling/Trash Bin	178
KURS	Work Tools – Desk Top Reference Shelf	201
KURS-0010-H	Work Tools – Reference Shelves	203
KURS-0012-B	Work Tools – Reference Shelves	203
KURS-0019-H	Work Tools – Reference Shelves	203
KUSH-0408-H	Work Tools – Mini Shelf	202
KUTC-0000-H	Work Tools – Tool Cup	202
KUWH-0202	Workstation Accessories – Bag Hook	208
KZTB	Work Tools — Mounting – Belong Systems Tile — External Mount for use with Compose Panels	199
LBJ1	Lighting — Haworth Collection – Freestanding Lighting	165
LBJ2	Lighting — Haworth Collection – Freestanding Lighting	165
LBJ3	Lighting — Haworth Collection – Mounted Lighting	165
LBJ4	Lighting — Haworth Collection – Mounted Lighting	165
LCF1-6009	Lighting — Haworth Collection – Floor Light	167
LCT1-1708	Lighting — Haworth Collection – Table Light	167
LL31-2210-NFLC	Lighting — Haworth Collection – Table Light	173
LL32-2210-NGLC	Lighting — Haworth Collection – Grommet Mounted Light	173
LLC1	Lighting — Haworth Collection – Worksurface Mounted Lighting	170
LLL1	Lighting — Haworth Collection – Freestanding Lighting	169
LLL2	Lighting — Haworth Collection – Freestanding Lighting	169
LLL3	Lighting — Haworth Collection – Freestanding Lighting	169
LLM1	Lighting — Haworth Collection – Mounted Lighting	171
LLM1	Lighting — Haworth Collection – Mounted Lighting	171
LLM2	Lighting — Haworth Collection – Mounted Lighting	171
LLU2	Lighting — Haworth Collection – Mounted Lighting	171
LRFO-5208	Lighting — Haworth Collection – Floor Light	166
LRT1-1408	Lighting — Haworth Collection – Table Light	166
LSET	Lock Programs – HW Lock Plugs and Keys	213
LUPT	Lighting — Haworth Collection – Table Light	174
LUTA	Lighting — Haworth – Adaptable LED Task Light - Add-On Kit	161
LUTD-0017-1NULDN	Lighting — Haworth – Reed Premier™ Add-On LED Task Light — For Use with Reed Premier Starter LED Task Lights	163
LUTN	Lighting — Haworth – Adaptable LED Task Light - Stand-Alone	160

Index

<u>Product Code</u>	<u>Product Description</u>	<u>Page</u>
LUTS-0000	Lighting — Haworth – Reed Premier™ Add-On Occupancy Sensor	163
LUTS-0017-12ULD6	Lighting — Haworth – Reed Premier™ Starter LED Task Light	162
LUTS-0017-19ULD5	Lighting — Haworth – Reed Premier™ Stand-Alone LED Task Light	162
LUTT	Lighting — Haworth – Adaptable LED Task Light - Starter Kit	160
LUV1	Lighting — Haworth – Voyage without Occupancy Sensor	164
LUV2	Lighting — Haworth – Voyage with Occupancy Sensor	164
MAC-0001	Workstation Accessories – Make-A-Corner	207
NECG-V	Wire Management – Vertical Cable Guide	186
NEH-8	Wire Management – Wire Management Loop	185
QBFC_F	Storage – Cushion Top	183
SCD-19	Workstation Accessories – Steel Center Drawer	207
TA01-0220	Grommets	157
TA01-0225	Wire Management – Wire Manager Clips	185
TA01-0228-F	Wire Management – Planes C-Leg Training Table Vertical Wire Manager	188
TABC	Wire Management – Basket Cover	187
TAWB	Wire Management – Wire Management Basket	187
TDD-MA-FS	Ergotron Monitor Mount – Dual Monitor	132
TDD-MA-GR	Ergotron Monitor Mount – Dual Monitor	132
TDD-MA-PA	Ergotron Monitor Mount – Dual Monitor	132
TDD-MA-PA	Ergotron Monitor Mount – Dual Monitor	132
TDS-MA-FS	Ergotron Monitor Mount – Single Monitor	131
TDS-MA-GR	Ergotron Monitor Mount – Single Monitor	131
TDS-MA-PA	Ergotron Monitor Mount – Single Monitor	131
TDS-MA-PA-251	Ergotron Monitor Mount – Single Monitor	131
Two-Piece Clamp	Ergotron Monitor Arm – Dual Direct Arm	123
Two-Piece Clamp	Ergotron Monitor Arm – Single Arm	126
Two-Piece Clamp	Ergotron Monitor Arms – Single Arm	120
TYVW	Wire Management – Vertical Wire Channel - Leg Attached	187
UKMCBK	Ergotron Keyboard Tray – Keyboard Tray with Mouse Pad	116
VZAC-0000-H	Workstation Accessories – Compose All-Purpose Hook	208
VZAC-0000-P	Workstation Accessories – Compose All-Purpose Hook	208
VZAW-0000-V	Wire Management – Compose Task Light Cord Manager	188
WC-6	Wire Management – UniGroup Too, UniGroup and PLACES Wire Manager	188
WQAG	Grommets	157
WQAG	Lighting — Haworth Collection – Grommet — For Use with Brazo Grommet Mounted Light Only	165
WUAC-WSG	Grommets	157
WUAW-PNH	Wire Management – Horizontal Wire Management	186
ZUAP-0000-PAN	Electrical Components – Power Tap Bracket — Adjustable	29
ZUAP-0000-PFD	Electrical Components – Power Tap Bracket — Fixed	29
ZUAP-0000-PGH	Electrical Components – Power Tap Bracket with Grommet	30
ZUAP-0000-PUR	Electrical Components – Power Tap Bracket — Under Surface	30

Warranty

Ergotron branded products in this price list are covered exclusively by the warranty statement below.

All Ergotron® products will remain free of defects in material and workmanship for a period of five years from the date of receipt of the product, subject to any exclusions and limitations as set forth below.

Ten-year warranty on all LX and MX Ergotron Products, purchased on or after August 1, 2014

Zip Charging Systems: Lifetime material/workmanship; three years electrical components; one year cables (power/Ethernet)

Ten-year warranty on LearnFit Adjustable Standing Desk (24-481-003)

Three-year warranty on all Neo-Flex® Ergotron Products

Original Equipment Manufacturer (OEM) Products resold by Ergotron are warranted by the respective manufacturer

FURTHER EXCLUSIONS AND LIMITATIONS

These warranties do not cover product abuse, modification and failure to adhere to product instructions, improper operations and/or misuse. Ergotron is not responsible for damage arising from failure to follow instructions relating to the product's intended use. Ergotron is not responsible for injury or loss caused by or associated with the installation and/or use of equipment in any manner other than in strict conformance with the instructions set forth in its installation manuals, supplemental assembly and installation instruction sheets, technical bulletins and/or product literature. You will provide Ergotron immediate written notice of any personal injury resulting from the use of Ergotron products.

Ergotron does not warrant damages or defects to the Ergotron product under the following conditions: an Act of God, unauthorized service or repair of the Ergotron products, damage from electrical power problems, usage of parts or components not supplied by Ergotron, failure to follow product instructions and guidelines, unauthorized changes to the Ergotron product, shipping damage (other than original shipment from Ergotron), failure to perform preventative maintenance, or damage caused by peripherals or software or from other external sources.

EXCLUSIVE REMEDY

Warranty Repair: In the event that any Ergotron equipment becomes defective in material or workmanship during the warranty period, Ergotron will determine with you if the product defect is covered under warranty. Ergotron, at its sole discretion, may replace or repair the unit determined to be under warranty at a designated Ergotron location or at your location. The labor costs associated with the repair of the product may be the responsibility of Ergotron if determined to be under warranty. You must receive pre-approval by Ergotron for the labor costs prior to repair or replacement of warranty products. You must contact Ergotron to obtain a Return Material Authorization (RMA) number. An RMA number may be obtained by contacting Ergotron Customer Care online or by telephone within your specific region. Contact information is available to you on the Ergotron web site at www.ergotron.com. Performance of any repair or replacement on product under warranty does not renew or extend the warranty period.

Non-Warranty Repair: You may return a product for repair that is not covered by warranty only if you have received a preapproved RMA number from Ergotron Customer Care. Labor costs and freight charges associated with non-warranty repair will be the sole responsibility of the customer, reseller or installer/integrator. A standard repair fee, specific to the product, is charged for any product that is repaired outside of the warranty period. Repairs on products out of warranty also carry a 90-day warranty, effective the day that you receive the item after repair.

For products that are not covered under warranty, Ergotron offers you the following options:

You may upgrade to a newer, functionally equivalent product at a normal list price

Ergotron will return the product to you

You can request in writing that Ergotron appropriately dispose of the product for you. A fee may apply for this service as designated by local law

Non-Defective Products: You are notified if, after examining and testing a returned product, Ergotron concludes that the product is not defective. The product is returned to you and you would be responsible for the freight charges associated with the return.

WARRANTY DISCLAIMER

Except as expressly set forth in this Limited Warranty and to the greatest extent allowed by law, Ergotron makes no other representations, warranties or conditions, express or implied, including any implied representations, warranties or conditions of merchantability, fitness for a particular purpose, non-infringement, and noninterference. Ergotron does not warrant that your use of the Ergotron product will be uninterrupted or error free. Any implied warranties that may be imposed by law are limited in duration to the Limited Warranty period, to the greatest extent allowed by law. Some states or countries do not allow a limitation on how long an implied warranty lasts or the exclusion or limitation of incidental or consequential damages for consumer products. In such states or countries, some exclusions or limitations of this Limited Warranty may not apply to you. This Limited Warranty is subject to change without notification.

Ergotron devices are not intended to cure, treat, mitigate or prevent any disease.

WARRANTY TRANSFERABILITY

This Limited Warranty is available only to the original end consumer and is non-transferable. For this warranty to be valid, the Ergotron product must have been purchased directly from an authorized distributor, reseller and/or authorized representative of Ergotron.

For additional information reference Ergotron.com or warranty inquiries contact Ergotron at 844-429-9678 or email haworth@Ergotron.com.

Ergotron Limited Warranty Terms and Conditions

©Ergotron Inc.

Effective Date: 1 June 2017

Content is subject to change without notification

Product Compatibility and Limited Warranty Policy

Great Expectations

You have them as a Haworth customer and so do we. And because we value our customers, we cover our products with the Haworth North America Product Compatibility and Limited Warranty Policy.

Our Commitment To Product Compatibility – Integrated Product Platforms

As a market leader in the design and manufacture of workspaces that adapt to change, we strive to maintain product compatibility within our various generations of integrated product platforms. This benefits the customer who desires to update or modify their work environment. It also benefits the customer needing to replace a product due to damage or other reasons but which is no longer manufactured or is otherwise unavailable, such as a fabric or finish that is discontinued because of changing market preferences. In both circumstances, we often can provide products with comparable function and performance.

Our Commitment To Product Quality – The Haworth North America Limited Warranty

To ensure customer satisfaction and peace of mind, we stand behind our products with the Haworth North America Limited Warranty. To review the current version of the limited warranty including its terms and conditions, please go to:

www.haworth.com/warranty or contact OneTouch@Haworth.com or 1 877 429 6784.

Warranty Requests or Questions

For questions or service requests pertaining to the Haworth Limited Warranty, please contact your Haworth dealer.

If you are unsure who your dealer is, please contact **OneTouch@Haworth.com or 1 877 429 6784.**

Effective: September 1, 2021

Terms of Sale

The Terms of Sale apply to all products in the North America Price Lists. To review the current version of the North American Terms of Sale, please go to:

www.haworth.com/terms-of-sale or contact OneTouch@Haworth.com or 1 877 429 6784.

Effective: September 2, 2022

HAWORTH

HAWORTH® is a registered trademark of Haworth, Inc.
© Haworth, Inc. All rights reserved. 2024.2.24 | Item #LIT21002
haworth.com | 800 344 2600

Electrical Components

Belong Power 65W

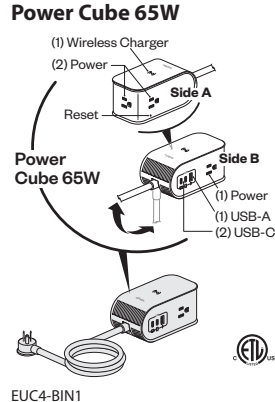
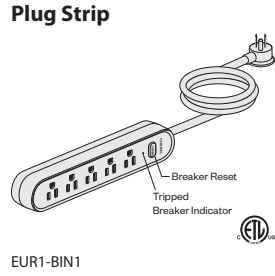
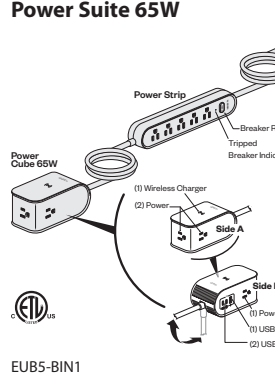
	Description	Number	Price
 <p>(1) Wireless Charger (2) Power Reset Side A Side B (1) Power (1) USB-A (2) USB-C</p> <p>Power Cube 65W</p> <p>EUC4-BIN1</p>	<p>Power Cube 65W Pack of 6</p>	<p>EUC4-BIN1-31020YN</p>	<p>\$2370.00</p>
	<p>Features</p> <ul style="list-style-type: none"> Includes six power cubes, each with three 120V receptacles (NEMA 5-15R), one USB-A charging port, two USB-C charging ports, one wireless charger, circuit breaker with reset pin hole, and 9'(2743mm) hinged braided power cord with low profile plug (NEMA 5-15P). Can be freestanding on worksurface or be used with appropriate mounting bracket. 15W (wireless) charging coil on top of cube. USB-A and USB-C offer rapid charging capability for a variety of devices. USB-A provides single port max charging 60W. Each USB-C provides single port max charging 65W. Available in charcoal TR-K or snow TR-FM. Power Cube has non-slip pad on bottom. UL 962A listed Furniture Power Distribution Unit. 	<p>To Order, Specify:</p> <ol style="list-style-type: none"> Product number. Trim color. TR-K Charcoal TR-FM Snow 	
	<p>Specification Tips</p> <ul style="list-style-type: none"> For additional information on charging refer to the Belong Power 65W charging guide on haworth.com. Brackets (EUCB) are optional and can be separately specified. Belong Power Units, (Power Suite, Power Cube and Plug Strip), are not designed or UL/CSA listed for daisy-chain applications. Application may require approval of local authority having jurisdiction (AHJ); ensure compliance before placing orders and installation. 		
 <p>Breaker Reset Tripped Breaker Indicator</p> <p>Plug Strip</p> <p>EUR1-BIN1</p>	<p>Plug Strip Pack of 6</p>	<p>EUR1-BIN1-50000M</p>	<p>\$490.50</p>
	<p>Features</p> <ul style="list-style-type: none"> Includes six plug strips, each with five 120V receptacles (NEMA 5-15R), circuit breaker with a reset indicator light, and 9'(2743mm) braided power cord with low profile plug (NEMA 5-15P). Plug Strip can mount in wire management tray or mount directly to the underside of the worksurface without additional bracket. Plug Strip has keyhole slots for mounting below worksurface or can be mounted to the back edge of the worksurface using separately specified Plug Strip Brackets (EUPB). Available in charcoal TR-K or snow TR-FM. UL 962A listed Furniture Power Distribution Unit. 	<p>To Order, Specify:</p> <ol style="list-style-type: none"> Product number. Trim color. TR-K Charcoal TR-FM Snow 	
	<p>Specification Tips</p> <ul style="list-style-type: none"> Recommended for 23"(584mm) deep surfaces which cannot accommodate a wire management tray. Belong Power Units, (Power Suite, Power Cube and Plug Strip), are not designed or UL/CSA listed for daisy-chain applications. Application may require approval of local authority having jurisdiction (AHJ); ensure compliance before placing orders and installation. 		
 <p>Power Strip Breaker Reset Tripped Breaker Indicator (1) Wireless Charger (2) Power Side A Side B (1) Power (1) USB-A (2) USB-C</p> <p>Power Suite 65W</p> <p>EUBS-BIN1</p>	<p>Power Suite 65W Pack of 6</p>	<p>EUBS-BIN1-81020YN</p>	<p>\$3150.00</p>
	<p>Features</p> <ul style="list-style-type: none"> Includes six power suites, each with three 120V receptacles (NEMA 5-15R), one USB-A charging port, two USB-C charging ports, one wireless charger, one connected plug strip with five 120V receptacles (NEMA 5-15R), circuit breaker, and 9'(2743mm) hinged braided power cord with low profile plug (NEMA 5-15P). Cord connecting plug strip to power cube is 4'(1219mm). Power Cube can be freestanding on worksurface or be used with appropriate mounting bracket. Plug strip can mount in wire management tray or mount directly to the underside of the worksurface without additional bracket. Available in charcoal TR-K or snow TR-FM. Power Cube includes: <ul style="list-style-type: none"> 15W (wireless) charging coil on top of cube. USB-A and USB-C offer rapid charging capability for a variety of devices. USB-A provides single port max charging 60W. Each USB-C provides single port max charging 65W. Non-slip pad on bottom. Power Cube included with the Power Suite does not include the reset feature. Plug Strip includes: <ul style="list-style-type: none"> Circuit breaker with a reset indicator light. Keyhole slots for mounting below worksurface. UL 962A listed Furniture Power Distribution Unit. 	<p>To Order, Specify:</p> <ol style="list-style-type: none"> Product number. Trim color. TR-K Charcoal TR-FM Snow 	
	<p>Specification Tips</p> <ul style="list-style-type: none"> Plug Strip designed to be mounted below worksurface for long term connection. Power Cube is mounted above the surface for a convenient power option. Recommended for 23"(584mm) deep surfaces which cannot accommodate a wire management tray. Belong Power Units, (Power Suite, Power Cube and Plug Strip), are not designed or UL/CSA listed for daisy-chain applications. Application may require approval of local authority having jurisdiction (AHJ); ensure compliance before placing orders and installation. 		

Electrical Components

Belong Power 65W

	Description	Number	Price
Plug Strip Brackets	Edgeband	EUPB-0000-WJP	\$ 85.00
	Knife Edge	EUPB-0000-WFP	130.00
	VSU/Tackboard	EUPB-0000-TJP	120.00

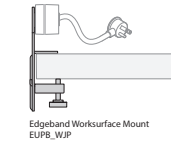
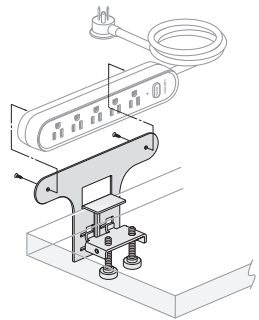

EUPB-WJP

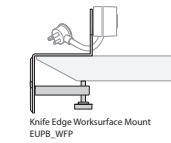
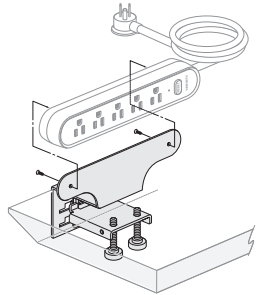

EUPB-WFP

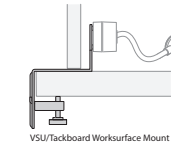
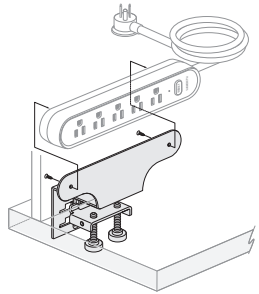

EUPB-TJP

Features

- Includes one mounting bracket and thumb screws.
- For use with Belong Plug Strip only.
- Available in standard finishes.

Specification Tips

- Accommodates 1.18" (30mm) - 2" (51mm) thick tops.
- Adjustable bracket mounts Belong Plug Strip to the edge of worksurface with thumb screws for ease of relocation.
- To mount plug strip to the bracket, use hardware provided with the plug strip.
- Not for use with Intuity hatches.
- Application may require approval of local authority having jurisdiction (AHJ); ensure compliance before placing orders and installation.

To Order, Specify:

- 1) Product number.
- 2) Trim color.

Electrical Components

Belong Hatch

	Description	Number	Price
<p>Cover</p> <p>Trim Ring</p> <p>Light Plate</p> <p>Trim Ring</p> <p>EUAH-0512</p>	For use with 1.18"(30mm) worksurfaces		
	Cover with trim ring	EUAH-0512-AYNNS	\$30.00
	Light Plate with trim ring	EUAH-0512-AYNNM	65.00
	For use with 2"(51mm) worksurfaces		
	Cover with trim ring	EUAH-0512-ANNYS	\$30.00
	Light Plate with trim ring	EUAH-0512-ANNYM	65.00

Features

- Includes trim ring with tabs, cover or light plate.
- Available in two configurations: cover with trim ring or light plate with trim ring.
- Light plate configuration to be used with the separately specified Talia light located in the Ancillary Price List.
- Belong Hatch will sit flush with the worksurface and will always be centered on the worksurface with the exception of Upside Worksurface 90° Equal Corner - Wrap-Around or 90° Extended Corner-Wrap-Around which will be placed on the worksurface side with a partial understructure always.
- Trim ring is 12"(305mm) wide and 5"(127mm) deep.
- Available in two color choices of TR-K (Charcoal) or TR-FM (Snow).
- Trim ring and cover are plastic, light plate is painted steel.

To Order, Specify:

- 1) Product number.
- 2) Trim color.

Specification Tips

- Designed to work with Belong Wire Management Tray (EUWT).
- Cannot be used on Planes Training or Collaborative tables due to interference with understructures.
- Can be placed on Adaptable Worksurfaces, Planes, Planes LT, Upside, Jive C-Leg, Jive T-Leg and Compose Echo. Each product has specification restrictions, reference product specification guide.
- Belong Hatch may be retrofitted to existing worksurfaces, (with a cut sheet), that do not interfere with the understructures.

Belong Hatch Planning Guidelines

Product Line	Planes	Planes LT		Upside		Compose Echo	Adaptable Worksurface	Jive Tables	
Leg Style	C-Leg (2-leg and 3-leg)	C-Leg (2-leg and 3-leg)	T-Leg	C-Leg	T-Leg	L-Leg	N/A	C-Leg	T-Leg
Hatch Cutout Locations (From back edge of worksurface to center of hatch cutout)	9 1/8"	7 7/8"	6 1/2"	6 1 1/16"	6 1/2"	7"	6 3/4"	3 3/4"	7 1/2"
Wire Management Tray Location	Centered on Hatch	Centered on Hatch	Centered on Hatch	Centered on Hatch and frame rails	Centered on Hatch	Centered on Hatch	Centered on Hatch	Centered on Hatch	Centered on Hatch
⊘ Don't Widths that cannot accept Belong Hatch and Belong Wire Management Tray	46", 52" Wide	46" Wide	46" Wide	46", 52", 58" Wide Min 58", 64" for Hatch	Upside 2-Leg Rectangular 46", 52" Wide	46" Wide	24" Wide	For 24"D: 36", 42", 48", 54" Wide For 30"D: 36", 42", 48", 54" Wide (Flip Tops Not Allowed)	For 24"D: 36", 42", 48", 54" Wide For 30"D: 36", 42", 48", 54" Wide (Flip Tops Not Allowed)
Compose Echo Screens	All	All	All	All	All	Allowed	Allowed, must match the width of a convergent worksurface	Corner and Back Screens fit all worksurfaces sizes allowed.	Corner and Back Screens fit all worksurfaces sizes allowed.
Belong Screens	Allowed, but nominal width of screen must be 4" smaller than nominal width of Worksurface (ie 58W Worksurface needs 54W or smaller screen)	Allowed, but nominal width of screen must be 4" smaller than nominal width of Worksurface (ie 58W Worksurface needs 54W or smaller screen)	Allowed, but nominal width of screen must be 4" smaller than nominal width of Worksurface (ie 58W Worksurface needs 54W or smaller screen), 42W and 48W screens will not fit centered with tray in this location due to interference with tray mounting brackets	Nominal width of screen 2" smaller, per side, than nominal width of Worksurface (ie 58W Worksurface needs 54W or smaller screen).	Allowed, but nominal width of screen must be 2" smaller, per side, than nominal width of Worksurface (ie 58W Worksurface needs 54W or smaller screen), 42W and 48W screens will not fit centered with tray in this location due to interference with tray mounting brackets	54" or greater fits 30" base. Screens must be sized down from Worksurface size. Screen size cannot be greater than Worksurface size.	Allowed, to match the width of a convergent worksurface	Back Screens fit all worksurfaces sizes marked OK in column H	Back Screens fit all worksurfaces sizes marked OK in column H
Belong Plus Screens	Allowed, match width of worksurface	Allowed, match width of worksurface	Allowed, match width of worksurface	Allowed, match width of worksurface	Allowed, match width of worksurface	42" fits on 30" base. 30" fits on 22" base. Screens above 42" cannot be used with wireway. Screen size cannot be greater than Worksurface size.	Allowed, to match the width of a convergent worksurface	Back Screens fit all worksurfaces sizes marked OK in column H	Back Screens fit all worksurfaces sizes marked OK in column H
Planes Modesty Panel	54W and larger allowed, match width of worksurface, modesty nominal must be 4" smaller than nominal Worksurface width	54W and larger allowed, match width of worksurface, modesty nominal must be 4" smaller than nominal Worksurface width, 42W and 48W modestys will not fit centered with tray in this location	54W and larger allowed, match width of worksurface, modesty nominal must be 4" smaller than nominal Worksurface width, 42W and 48W modestys will not fit centered with tray in this location	54W and larger allowed, match width of worksurface, modesty nominal must be 4" smaller than nominal Worksurface width, 42W and 48W modestys will not fit centered with tray in this location	54W and larger allowed, modesty nominal must be 4" smaller than nominal Worksurface width, 42W and 48W screens will not fit centered with tray in this location	Not Allowed	Allowed to match the width of a convergent worksurface	Depths; 24" allowed, 30" Not Allowed	Widths: 60", 66", & 72" allowed All depths excluding 30" fit
Compose Echo Modesties	Not Allowed	Not Allowed	Not Allowed	Not Allowed	Not Allowed	Allowed	Not Allowed	Not Allowed	Not Allowed
Monitor Arms (Ergotron)	Clamp mount may be mounted to the left or right of the hatch without interference. If placing a grommet mount arm, please be aware of the understructure or mechanical components under the worksurface. If using a clamp style bracket, please refer to the usable space between the clamp and screens.	Clamp mount may be mounted to the left or right of the hatch without interference. If placing a grommet mount arm, please be aware of the understructure or mechanical components under the worksurface. If using a clamp style bracket, please refer to the usable space between the clamp and screens.	Clamp mount may be mounted to the left or right of the hatch without interference. If placing a grommet mount arm, please be aware of the understructure or mechanical components under the worksurface. If using a clamp style bracket, please refer to the usable space between the clamp and screens.	Clamp mount may be mounted to the left or right of the hatch without interference. If placing a grommet mount arm, please be aware of the understructure or mechanical components under the worksurface. If using a clamp style bracket, please refer to the usable space between the clamp and screens.	Clamp mount may be mounted to the left or right of the hatch without interference. If placing a grommet mount arm, please be aware of the understructure or mechanical components under the worksurface. If using a clamp style bracket, please refer to the usable space between the clamp and screens.	Clamp mount may be mounted to the left or right of the hatch without interference. If placing a grommet mount arm, please be aware of the understructure or mechanical components under the worksurface. If using a clamp style bracket, please refer to the usable space between the clamp and screens.	Clamp mount may be mounted to the left or right of the hatch without interference. If placing a grommet mount arm, please be aware of the understructure or mechanical components under the worksurface. If using a clamp style bracket, please refer to the usable space between the clamp and screens.	Clamp mount may be mounted to the left or right of the hatch without interference. If placing a grommet mount arm, please be aware of the understructure or mechanical components under the worksurface. If using a clamp style bracket, please refer to the usable space between the clamp and screens.	Clamp mount may be mounted to the left or right of the hatch without interference. If placing a grommet mount arm, please be aware of the understructure or mechanical components under the worksurface. If using a clamp style bracket, please refer to the usable space between the clamp and screens.