

HAWORTH

# Compose Storage

GSA Price List – August 2023



This price list is based upon Haworth's February 2023 commercial pricing.  
GENERAL SERVICES ADMINISTRATION FEDERAL SUPPLY SERVICE  
Authorized Federal Supply Scheduled Price List (Catalog) Office Furniture, Wood Casegoods and Tables  
(FSC Group 71, Part I, FSC Classes 7105, 7110, 7125 and 7195)  
Contract No: GS-03F-057DA | Contract Period: February 8, 2016 – February 7, 2026 | Business: Large  
Contractor: Haworth, Inc. | One Haworth Center | Holland, MI 49423-9576 | 1.616.393.3000





**This Haworth North American price book contains US list prices.**

Canadian customers can convert the US list price into their Canadian equivalent by going to [www.Haworth.com/Canada](http://www.Haworth.com/Canada) to find the current Canadian multipliers. These multiplier factors allow you to convert the US list price into a Canadian list price.

**HAWORTH, INC.**  
**GENERAL SERVICES ADMINISTRATION**  
**FEDERAL ACQUISITION SERVICES**

**Authorized Federal Supply Schedule**  
**Furniture**  
**(FSC Group 71, FSC Classes 7105, 7110, 7125 and 7195)**

Contract Number: GS-03F-057DA  
Contract Start Date: February 8, 2016  
Contract End Date: February 7, 2026  
Contractor: HAWORTH, INC.  
One Haworth Center  
Holland, MI 49423-9576  
1-616-393-3000  
<http://www.haworth.com/government>  
Business Size: Large

**Information for Ordering Activities**  
**I-FSS-600**

Online access to Haworth's Authorized Federal Supply Schedule contract ordering information, terms and conditions, and up-to-date product and discount listing can be found at GSA Advantage, eLibrary link [here](#).

# Table of Contents

---

<b>Statement of Line</b> .....	5-7
--------------------------------	-----

## **Pedestals and Accessories**

Mobile Pedestals .....	8
Pedestals .....	10
Pedestal Cushion .....	12
Pencil Tray .....	12
Storage-to-Panel Bracket .....	12

## **Lateral Files and Accessories**

Lateral Files .....	14
Open Shelf Lateral File .....	16
Combination Unit .....	18
File/Storage Cushion .....	20
Storage-to-Panel Bracket .....	20
Lateral File Hanging Bar .....	20

## **Storage Tops**

Individual/Common Storage Tops .....	21
Continuous Storage Tops .....	22
Off-modular Storage Tops .....	23

## **Storage**

Storage Unit with Doors .....	24
Storage Unit without Doors .....	26
Personal Storage Tower with Side Bookcase .....	29
Personal Storage Tower with Wardrobe .....	33
Wardrobes .....	36
Stack-on Storage .....	38
Finished Back .....	40

## **Worksurface Support Panel**

Worksurface Support Panel .....	41
Worksurface Support End .....	42
One-high Worksurface Support End .....	43

## **Finishes and Fabrics**

Finish/Color Legend .....	118
Fabrics/Color Legend .....	119

<b>Index</b> .....	120
--------------------	-----

<b>Lifetime Product Warranty</b> .....	Inside Back Cover
--	-------------------



# Statement of Line

## Mobile Pedestals — pages 8-9

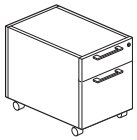

**BZMA-CLN**  
Exposed Caster Base  
Box/File Pedestal

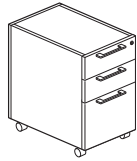

**BZMH-CLN**  
Exposed Caster Base  
Box/Box/File Pedestal

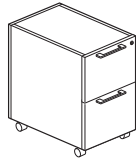

**BZMJ-CLN**  
Exposed Caster Base  
File/File Pedestal

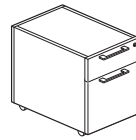

**BZMA-GLN**  
Side Panel Caster Base  
Box/File Pedestal

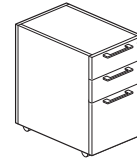

**BZMH-GLN**  
Side Panel Caster Base  
Box/Box/File Pedestal

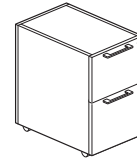

**BZMJ-GLN**  
Side Panel Caster Base  
File/File Pedestal

## Stationary Pedestals — pages 10-11

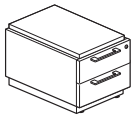

**BZPX**  
Box/Box Pedestal

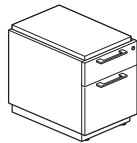

**BZPA**  
Box/File Pedestal

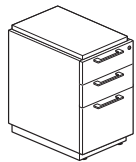

**BZPH**  
Box/Box/File Pedestal

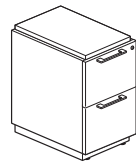

**BZPJ**  
File/File Pedestal

## Pedestals Accessories — page 12



**BZSC-F**  
Pedestal Cushion

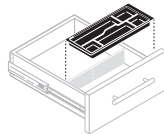

**JPTA-6**  
Pencil Tray

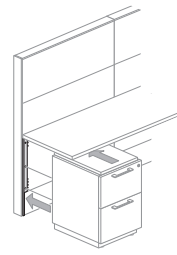

**BZBG**  
Storage-to-Panel Bracket

## Lateral File — pages 14-15

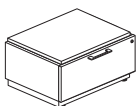

**BZL1**  
1H Lateral File

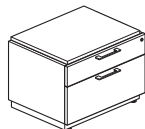

**BZLA**  
1.5H Lateral File

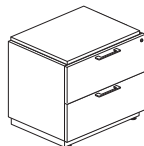

**BZL2**  
2H Lateral File

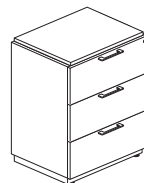

**BZL3**  
3H Lateral File

## Open Shelf Lateral File — pages 16-17

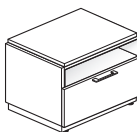

**BZLV**  
1.5H Open Shelf Lateral  
File

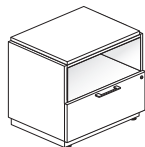

**BZLZ**  
2H Open Shelf Lateral File

## Combination Unit — pages 18-19

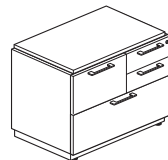

**BZLC**  
Right Hand Combination  
Unit

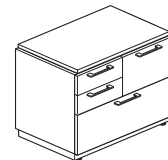

**BZLB**  
Left Hand Combination  
Unit

# Statement of Line

## Lateral File/Storage Accessories — page 20

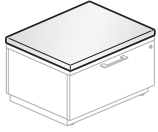

BZSC-F  
File/Storage Cushion

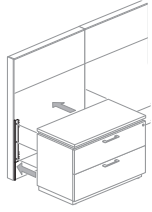

BZBG  
Storage-to-Panel Bracket

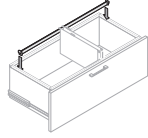

BZAH  
Lateral File Hanging Bar

## Storage Tops — pages 21-23



BZTR  
Individual/Common

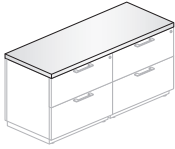

BZTR  
Individual/Common

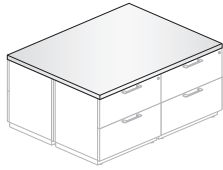

BZTR  
Individual/Common

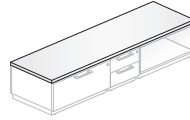

BZTB  
Continuous

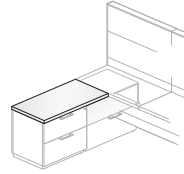

BZTM  
Off-Modular

## Storage Unit with and without Doors — pages 24-27

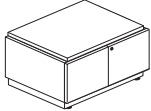

BZSS-LL1T  
1H Storage Unit with  
Doors

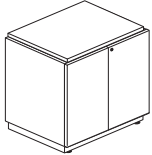

BZSS-LL2T  
2H Storage Unit with  
Doors

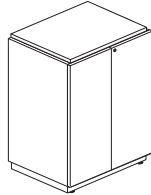

BZSS-LL3T  
3H Storage Unit with  
Doors

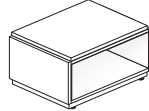

BZSN-LN1N  
1H Storage Unit without  
Doors

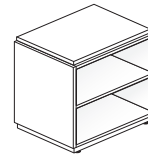

BZSN-LN2N  
2H Storage Unit without  
Doors

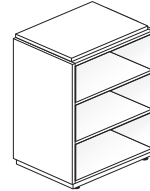

BZSN-LN3N  
3H Storage Unit without  
Doors

## Personal Storage Tower — pages 29-35

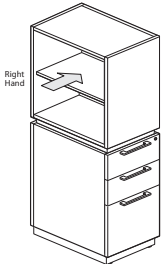

BZRH-LLR  
Side Bookcase - Right Hand

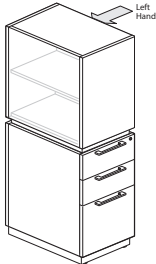

BZRH-LLL  
Side Bookcase - Left Hand

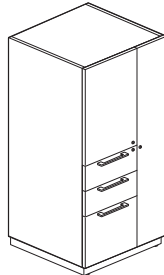

BZVH-LR  
Wardrobe - Right Hand

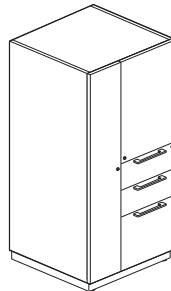

BZVH-LL  
Wardrobe - Left Hand

# Statement of Line

## Wardrobes — pages 36-37

## Stack-on Storage — pages 38-39

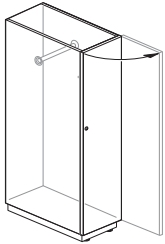

**BZWK-LLR**  
Locking Right Hand Swing  
Wardrobe



**BZWK-LLL**  
Locking Left Hand Swing  
Wardrobe

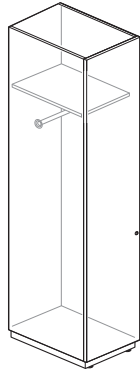

**BZWK-LLL**  
Locking Left Hand Swing  
Wardrobe

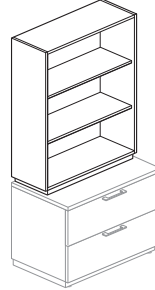

**BZDL-LNNSNN**  
Without Doors Stack-on  
Storage

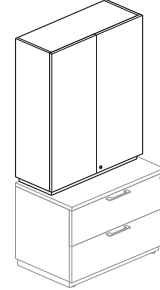

**BZKL-LLFTSLN**  
Full Height Doors Stack-on  
Storage

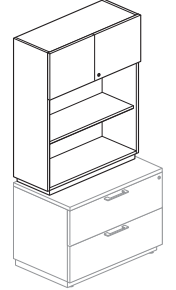

**BZKL-LLPTSLN**  
Partial Doors on Top  
Stack-on Storage

## Finished Back — page 40

## Worksurface Support — pages 41-43

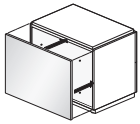

**BZAB**  
Finished Back

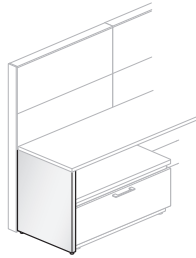

**ZZFS**  
Panel

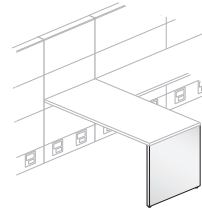

**ZUFS**  
End

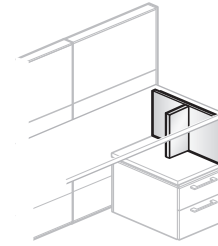

**BZHU**  
End

# Mobile Pedestals

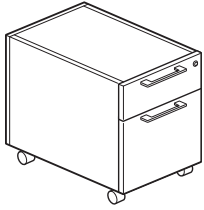

BZMA-CLN

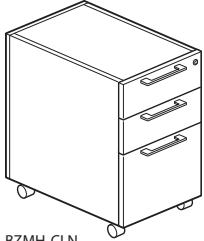

BZMH-CLN

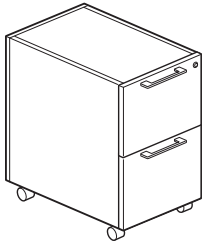

BZMJ-CLN

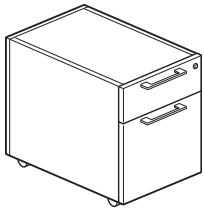

BZMA-GLN

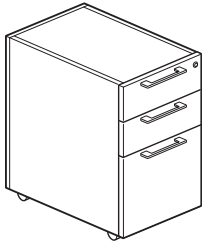

BZMH-GLN

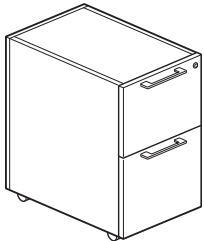

BZMJ-GLN

## Features

- Mobile Pedestals include:
  - Drawer pull options.
  - Exposed caster base or side panel base with casters options.
  - Black miterfold drawer interiors.
  - Laminate case with back and laminate drawer fronts. Laminate case edgeband matches laminate drawer front edgeband.
- Box drawers include one black plastic divider each.
- One black plastic pencil tray included with Box/File or Box/Box/File pedestal.
- File drawer includes integrated file hanging system for letter front-to-back filing.
- All drawers have full extension slides.
- Standard with lock; lock plugs available in chrome or black.
- For lock options, refer to Lock Program section of the Accessories Price List.
- Drawer Pull Options:
  - Crescent (7), Linear (8) and Classic (9) pulls standard in Brushed Nickel finish (no specification required).
  - Patterns (6) pull standard in Anodized Aluminum finish (no specification required).
  - Integrated Aluminum J-Pull (K); aluminum finger pull requires trim color.
- Base Options:
  - Exposed Caster Base (C); includes two front locking swivel casters and two rear non-locking swivel casters.
  - Side Panel Base (G); includes four non-locking swivel casters; sides/front extend to floor visually hiding casters.
- Casters are standard in black and not height adjustable.
- Standard with installed counterweight.
- Case ships partially assembled, finished back and casters field installed.

## Specification Tips

- Mobile pedestal back and top are finished and intended for visual exposure.
- Cushion may be separately specified; recommended for use with a box/file pedestal.
- Refer to Specification Guide for planning information.

## To Order, Specify:

1) Product number, including:

### 1 Pull Options:

- 6** Patterns
- 7** Crescent
- 8** Linear
- 9** Classic
- K** Aluminum J-Pull

- 2) Case laminate surface color.
- 3) Lock plug trim color.
- 4) Aluminum J-Pull trim color, if applicable.
- 5) Laminate case edge trim color.

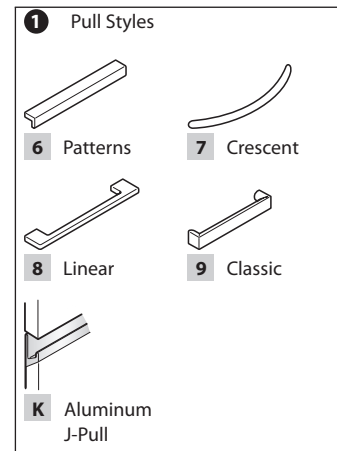

# Mobile Pedestals

Actual Height	Actual Depth	Actual Width	Description	Pull	Number	①	Laminate A	B
<b>Exposed Caster Base</b>								
20.2"(513mm)	17.68"(449mm)	15.5"(394mm)	Box/File	7,8,9	BZMA-1816-LLB	CLN	\$1858.69	\$1930.83
				K	BZMA-1816-LLBKCLN		2091.84	2163.98
				6	BZMA-1816-LLB6CLN		2055.99	2128.13
20.2"(513mm)	23.68"(601mm)	15.5"(394mm)	Box/File	7,8,9	BZMA-2416-LLB	CLN	\$1903.52	\$1975.66
				K	BZMA-2416-LLBKCLN		2136.67	2208.81
				6	BZMA-2416-LLB6CLN		2100.82	2172.96
26.2"(665mm)	17.68"(449mm)	15.5"(394mm)	Box/Box/File	7,8,9	BZMH-1816-LLB	CLN	\$2065.38	\$2154.09
				K	BZMH-1816-LLBKCLN		2415.12	2503.83
				6	BZMH-1816-LLB6CLN		2361.30	2450.01
26.2"(665mm)	23.68"(601mm)	15.5"(394mm)	Box/Box/File	7,8,9	BZMH-2416-LLB	CLN	\$2112.00	\$2200.71
				K	BZMH-2416-LLBKCLN		2461.74	2550.45
				6	BZMH-2416-LLB6CLN		2407.92	2496.63
26.2"(665mm)	17.68"(449mm)	15.5"(394mm)	File/File	7,8,9	BZMJ-1816-LLB	CLN	\$1942.82	\$2021.70
				K	BZMJ-1816-LLBKCLN		2175.97	2254.85
				6	BZMJ-1816-LLB6CLN		2140.12	2219.00
26.2"(665mm)	23.68"(601mm)	15.5"(394mm)	File/File	7,8,9	BZMJ-2416-LLB	CLN	\$1984.88	\$2063.76
				K	BZMJ-2416-LLBKCLN		2218.03	2296.91
				6	BZMJ-2416-LLB6CLN		2182.18	2261.06
<b>Side Panel Caster Base</b>								
20.9"(531mm)	17.68"(449mm)	15.5"(394mm)	Box/File	7,8,9	BZMA-1816-LLB	GLN	\$1858.69	\$1930.83
				K	BZMA-1816-LLBKGLN		2091.84	2163.98
				6	BZMA-1816-LLB6GLN		2055.99	2128.13
20.9"(531mm)	23.68"(601mm)	15.5"(394mm)	Box/File	7,8,9	BZMA-2416-LLB	GLN	\$1903.52	\$1975.66
				K	BZMA-2416-LLBKGLN		2136.67	2208.81
				6	BZMA-2416-LLB6GLN		2100.82	2172.96
26.9"(683mm)	17.68"(449mm)	15.5"(394mm)	Box/Box/File	7,8,9	BZMH-1816-LLB	GLN	\$2065.38	\$2154.09
				K	BZMH-1816-LLBKGLN		2415.12	2503.83
				6	BZMH-1816-LLB6GLN		2361.30	2450.01
26.9"(683mm)	23.68"(601mm)	15.5"(394mm)	Box/Box/File	7,8,9	BZMH-2416-LLB	GLN	\$2112.00	\$2200.71
				K	BZMH-2416-LLBKGLN		2461.74	2550.45
				6	BZMH-2416-LLB6GLN		2407.92	2496.63
26.9"(683mm)	17.68"(449mm)	15.5"(394mm)	File/File	7,8,9	BZMJ-1816-LLB	GLN	\$1942.82	\$2021.70
				K	BZMJ-1816-LLBKGLN		2175.97	2254.85
				6	BZMJ-1816-LLB6GLN		2140.12	2219.00
26.9"(683mm)	23.68"(601mm)	15.5"(394mm)	File/File	7,8,9	BZMJ-2416-LLB	GLN	\$1984.88	\$2063.76
				K	BZMJ-2416-LLBKGLN		2218.03	2296.91
				6	BZMJ-2416-LLB6GLN		2182.18	2261.06

# Pedestals

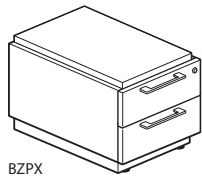

BZPX

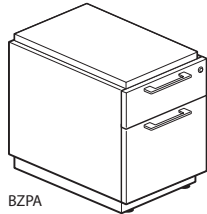

BZPA

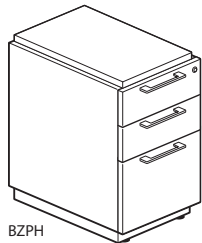

BZPH

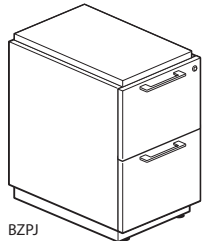

BZPJ

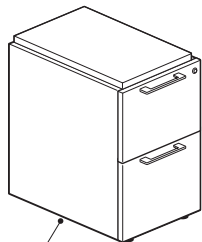

Side Panel Base

**Note:** Graphics shown with solid spacer.

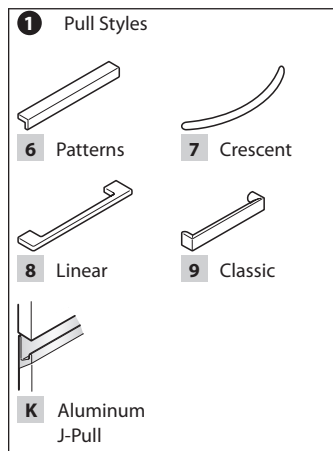

### Features

- Pedestals include:
  - Attachment hardware when applicable.
  - Base or leg and drawer pull options.
  - Floating spacer option has a finished top.
  - Solid spacer option has an unfinished top.
  - Laminate case with back and laminate drawer fronts. Laminate case edgeband matches laminate drawer front edgeband.
- Box drawers include one black plastic divider each.
- One black plastic pencil tray included with Box/Box, Box/File or Box/Box/File pedestal.
- File drawer includes integrated file hanging system for letter front-to-back filing.
- All drawers have full extension slides.
- Standard with lock; lock plugs available in chrome or black.
- For lock options, refer to Lock Program section of the Accessories Price List.
- Drawer Pull Options:
  - Crescent (7), Linear (8) and Classic (9) pulls standard in Brushed Nickel finish (no specification required).
  - Patterns (6) pull standard in Anodized Aluminum finish (no specification required).
  - Integrated Aluminum J Pull (K); aluminum finger pull requires trim color.
- Base/Leg Options:
  - Side Panel Base (E); sides/front extend to floor; side panels are part of case
  - Plinth Base with plastic edge (L); requires edge trim color
  - Chamfer Leg (P); requires trim color.
- Glide height adjustment ranges:
  - Chamfer leg - 1.25”(32mm)
  - Side Panel Base/Plinth Base - 2”(51mm)
- Spacer Options:
  - Floating Spacer (F); requires trim color (finished top).
  - Solid Spacer with plastic edge (L); requires edge trim color (unfinished top).
  - No Spacer (U); no surface specification required (unfinished top).
  - No Spacer (N); no surface specification required (finished top)
- Counterweight Option: (18” depth only)
  - Yes, counterweight is factory installed.
  - No, no counterweight.
- Floating and solid spacers are 1.19”(30mm)high.
- Case (with/without optional Counterweight) ships assembled; Spacers and Plinth Base/Legs require field installation.

### Specification Tips

- Finished Back is separately specified when pedestal back is exposed.
- Two-high box/box/file or file/file pedestal requires a solid or floating spacer for a 29”(737mm) high Adaptable worksurface application.
- For panel mounted applications; separately specify appropriate attachment brackets for support and load purposes.
- Pedestals:
  - with solid spacer are not intended for use with a knife edge Adaptable worksurface due to dimensional differences.
  - without spacer with finished or unfinished top may be used in a slip-fit or nested Adaptable worksurface application.
  - without spacer are for use with edgeband Adaptable worksurface only; not intended for use with knife edges due to dimensional differences.
  - 24”/30”(610-762mm) depth do not require counterweight.

### Specification Tips, cont.

- Counterweight: (18”(457mm) depth only)
  - may be used in pedestals with or without a separately specified finished back.
  - is required in a freestanding two-high box/box/file or file/file pedestal
  - is not required in pedestals attached to an Adaptable worksurface.
  - is not required for a one high box/box pedestal.
- Cushion may be separately specified for a freestanding pedestal; recommended for use with a one-high box/box pedestal.
- Refer to Pedestal Cushion page for planning information.

### To Order, Specify:

1) Product number, including:

#### 1 Pull Options:

- 6** Patterns
- 7** Crescent
- 8** Linear
- 9** Classic
- K** Aluminum J-Pull

#### 2 Base/Leg Options:

- E** Side Panel Base
- L** Plinth Base/Plastic Edge, add **\$265.27** list.
- P** Chamfer Leg, add **\$146.32** list.

#### 3 Spacer Options:

- F** Floating Spacer/finished top: 18”(457mm) deep, add **\$206.27** list.  
24”(610mm) deep, add **\$227.79** list.  
30”(762mm) deep, add **\$242.15** list.
- L** Solid Spacer/Plastic Edge/unfinished top, add **\$164.99** list.
- U** No Spacer/unfinished top.
- N** No Spacer/finished top.

#### 4 Counterweight Option (18” depth only):

- Y** Yes, add **\$89.64** list.
- N** No

- 2) Case laminate surface color.
- 3) Base/Leg trim color.  
Side Panel Base (E) - (No finish specification.)  
Plinth Base (L) - Edge trim color.  
Chamfer (P) - Trim color.
- 4) Spacer trim color.  
Floating Spacer (F) - Trim color.  
Solid Spacer (L) - Edge trim color.
- 5) Lock plug trim color.
- 6) Aluminum J-Pull trim color, if applicable.
- 7) Laminate case trim color.

# Pedestals

Height No Spacer	Actual Height W/Spacer	Actual Depth Inset Back*	Actual Width	Description	Pull	Number	① ② ③ ④				Laminate		
							A	B					
14.8" (376mm)	16.0" (406mm)	16.93" (430mm)	15.5" (394mm)	Box/Box	7,8,9	BZPX-1816-LLB	■	■	L	■	\$1267.78	\$1334.19	
						K	BZPX-1816-LLBK	■	■	L	■	1500.93	1567.34
14.8" (376mm)	16.0" (406mm)	22.93" (582mm)	15.5" (394mm)	Box/Box	7,8,9	6	BZPX-1816-LLB6	■	■	L	■	1465.08	1531.49
						K	BZPX-2416-LLB	■	■	L	■	N	\$1312.61
20.9" (531mm)	22.0" (559mm)	16.93" (430mm)	15.5" (394mm)	Box/File	7,8,9	BZPA-1816-LLB	■	■	L	■	\$1339.14	\$1411.28	
						K	BZPA-1816-LLBK	■	■	L	■	1572.29	1644.43
20.9" (531mm)	22.0" (559mm)	22.93" (582mm)	15.5" (394mm)	Box/File	7,8,9	6	BZPA-1816-LLB6	■	■	L	■	1536.44	1608.58
						K	BZPA-2416-LLB	■	■	L	■	N	\$1383.97
26.9" (683mm)	28.1" (714mm)	16.93" (430mm)	15.5" (394mm)	Box/Box/File	7,8,9	BZPH-1816-LLB	■	■	L	■	\$1545.83	\$1634.54	
						K	BZPH-1816-LLBK	■	■	L	■	1895.57	1984.28
26.9" (683mm)	28.1" (714mm)	22.93" (582mm)	15.5" (394mm)	Box/Box/File	7,8,9	6	BZPH-1816-LLB6	■	■	L	■	1841.75	1930.46
						K	BZPH-2416-LLB	■	■	L	■	N	\$1592.45
26.9" (683mm)	28.1" (714mm)	28.93" (735mm)	15.5" (394mm)	Box/Box/File	7,8,9	BZPH-2416-LLB	■	■	L	■	\$1639.10	\$1727.81	
						K	BZPH-2416-LLBK	■	■	L	■	N	1942.19
26.9" (683mm)	28.1" (714mm)	16.93" (430mm)	15.5" (394mm)	File/File	7,8,9	6	BZPH-2416-LLB6	■	■	L	■	1888.37	1977.08
						K	BZPH-3016-LLB	■	■	L	■	N	\$1639.10
26.9" (683mm)	28.1" (714mm)	28.93" (735mm)	15.5" (394mm)	File/File	7,8,9	BZPH-3016-LLB	■	■	L	■	\$1639.10	\$1727.81	
						K	BZPH-3016-LLBK	■	■	L	■	N	1988.84
26.9" (683mm)	28.1" (714mm)	16.93" (430mm)	15.5" (394mm)	File/File	7,8,9	6	BZPH-3016-LLB6	■	■	L	■	1935.02	2023.73
						K	BZPJ-1816-LLB	■	■	L	■	\$1423.27	\$1502.15
26.9" (683mm)	28.1" (714mm)	22.93" (582mm)	15.5" (394mm)	File/File	7,8,9	BZPJ-1816-LLB	■	■	L	■	\$1423.27	\$1502.15	
						K	BZPJ-1816-LLBK	■	■	L	■	1656.42	1735.30
26.9" (683mm)	28.1" (714mm)	28.93" (735mm)	15.5" (394mm)	File/File	7,8,9	6	BZPJ-1816-LLB6	■	■	L	■	1620.57	1699.45
						K	BZPJ-2416-LLB	■	■	L	■	N	\$1465.33
26.9" (683mm)	28.1" (714mm)	28.93" (735mm)	15.5" (394mm)	File/File	7,8,9	BZPJ-2416-LLB	■	■	L	■	\$1465.33	\$1544.21	
						K	BZPJ-2416-LLBK	■	■	L	■	N	1698.48
26.9" (683mm)	28.1" (714mm)	16.93" (430mm)	15.5" (394mm)	File/File	7,8,9	6	BZPJ-2416-LLB6	■	■	L	■	1662.63	1741.51
						K	BZPJ-3016-LLB	■	■	L	■	N	\$1507.41
26.9" (683mm)	28.1" (714mm)	28.93" (735mm)	15.5" (394mm)	File/File	7,8,9	BZPJ-3016-LLB	■	■	L	■	\$1507.41	\$1586.29	
						K	BZPJ-3016-LLBK	■	■	L	■	N	1740.56
26.9" (683mm)	28.1" (714mm)	22.93" (582mm)	15.5" (394mm)	File/File	7,8,9	6	BZPJ-3016-LLB6	■	■	L	■	1704.71	1783.59
						K	BZPJ-3016-LLBK	■	■	L	■	N	1704.71

\*Inset back unfinished.

## Pedestal Accessories

	Actual Height	Nominal Depth	Actual Width	Number ①	Fabric Grade				
					A	B	C	D	E
<b>Pedestal Cushion</b>	1.25"(32mm)	18"(457mm)	15.5"(394mm)	BZSC-1816-F	\$ 803.10	\$ 923.83	\$1059.21	\$1205.59	\$1350.08
	1.25"(32mm)	24"(610mm)		BZSC-2416-F	909.22	1046.42	1184.27	1333.22	1480.27
	1.25"(32mm)	30"(762mm)		BZSC-3016-F	1015.34	1169.01	1309.33	1460.85	1610.46



BZSC-F  
Class TA – SIN 33721;  
Discount Group X

### Features

- Includes one 1.25"(32mm) thick cushion with removable attachment.
- Pedestal cushions are dimensioned to accommodate units with inset back (S) or separately specified proud finished back (A).
- Field installed.
- COM yardage:  
18"(457mm) x 16"(406mm) - 1.1 yards  
24"(610mm) x 16"(406mm) - 1.4 yards  
30"(762mm) x 16"(406mm) - 1.7 yards

### To Order, Specify:

- 1) Product number, including:

### ① Unit Back Option:

- A Proud Finished Back
- S Inset Unfinished Back

- 2) Fabric and color.

### Specification Tips

- For use with Compose mobile or freestanding pedestals.
- Pedestal Cushion:
  - May be used on pedestals with finished or unfinished tops and on top of attached Compose Storage Top.
  - May not be placed directly on top of spacers.
- Not for use with X Series or V Series storage.
- Storage top is not required for use with Pedestal Cushion.
- Refer to Specification Guide for planning information.

	Height	Depth	Width	Number	Price
<b>Pencil Tray</b>	1.25"(32mm)	5.5"(140mm)	12.87"(327mm)	JPTA-6	\$53.13

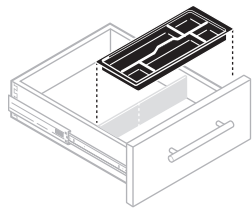

JPTA-6  
Class RA SIN 33721;  
Discount Group IX

### Features

- Includes one black plastic tray.
- Suspends from sides of 6"(152mm) drawer and slides for drawer access.

### To Order, Specify:

- 1) Product number.  
(No finish specification required.)

## Storage-to-Panel Bracket

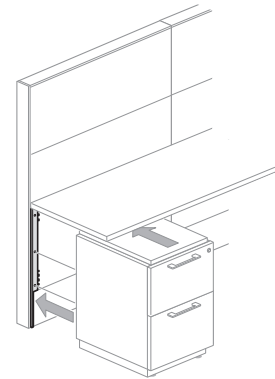

BZBG  
Class TA – SIN 33721;  
Discount Group X

Description	Number	Trim	
		A	B
For use with pedestal/ 2H storage	BZBG-0002	\$151.85	\$160.82
For use with pedestal/ 3H storage/ full height storage	BZBG-0003	151.85	160.82

### Features

- Includes one bracket and mounting screws.
- Installs into panel frame attachment slots and attaches to back side of lower storage or full height storage.
- Non-handed.
- **Installation requires field drilling which will deface storage unit or finished back.**

### To Order, Specify:

- 1) Product number.
- 2) Trim color.

### Specification Tips

- For use with 2H and 3H storage units and full height storage with Chamfer leg, plinth or side panel bases; height specific product number.
- Worksurface and lower storage unit must be same nominal depth.
- Designed for use with edgeband worksurfaces.
- **Not for use with:**
  - Knife edge worksurfaces
  - X Series or V Series storage
- For use with lower storage with unfinished insert back or separately specified finished proud back.
- Refer to Specification Guide for planning information.



This page intentionally blank

# Lateral Files

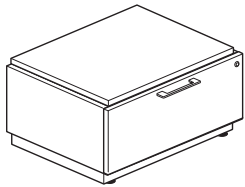

BZL1

**Note:** See features for 1H filing capabilities.

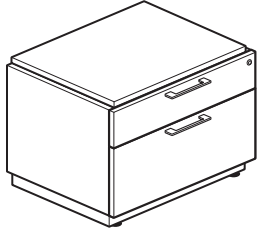

BZLA

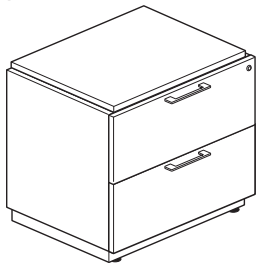

BZL2

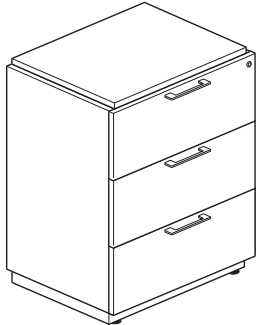

BZL3

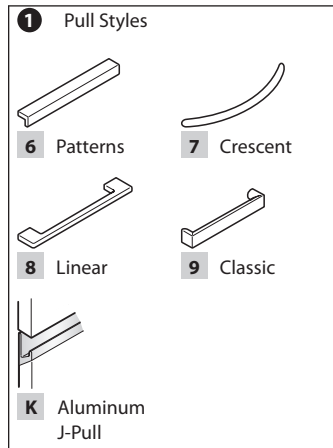

## Features

- Lateral Files include:
  - Base or leg and drawer pull options.
  - Floating spacer option has a finished top.
  - Solid spacer option has an unfinished top.
  - Black miterfold drawer interiors.
  - Laminate case with back and laminate drawer fronts. Laminate case edgeband matches laminate drawer front edgeband.
- File drawer includes integrated file hanging system and two file hangar bars per drawer.
  - 18”(457mm) D x 30”(762mm) W: letter front-to-back
  - 18”(457mm) D x 36”(914mm) W: letter/legal front-to-back
  - 24”(610mm) x 30”(762mm) D: letter front-to-back or legal side-to-side
  - 24”(610mm) D x 36”(914mm) W: letter/legal front-to-back or legal side-to-side
- Note - 1H Lateral File will accommodate a Pendaflex file folder without tabs. File drawer will not close if tabs are used.
- All drawers have full extension slides.
- Standard with lock; lock plugs available in chrome or black.
- For lock options, refer to Lock Program section of the Accessories Price List.
- Drawer Pull Options:
  - Crescent (7), Linear (8) and Classic (9) pulls standard in Brushed Nickel finish (no specification required).
  - Patterns (6) pull standard in Anodized Aluminum finish (no specification required).
  - Integrated Aluminum J-Pull (K); aluminum finger pull requires trim color.
- Base/Leg Options:
  - Side Panel Base (E); sides/front extend to floor; side panels are part of case.
  - Plinth Base with plastic edge (L); requires edge trim color.
  - Chamfer leg (P); requires trim color.
- Glide height adjustment ranges:
  - Chamfer leg - 1.25”(32mm)
  - Side Panel Base/Plinth Base - 2”(51mm)
- Spacer Options:
  - Floating Spacer (F); requires trim color (finished top).
  - Solid Spacer with plastic edge (L); requires edge trim color (unfinished top).
  - No Spacer (U); no surface specification required (unfinished top).
  - No Spacer (N); no surface specification required (finished top).
- Counterweight Option (Not available on 3H Lateral Files):
  - Yes, counterweight is factory installed.
  - No, no counterweight.
- Floating and solid spacers are 1.19”(30mm) high.
- Case (with/without optional Counterweight) ships assembled; Spacers and Plinth Base/Legs require field installation.

## Specification Tips

- Finished Back is separately specified when lateral file back is exposed.
- 2H lateral file requires a solid or floating spacer for a 29”(737mm) high Adaptable worksurface application.
- For panel mounted applications; separately specify appropriate attachment brackets for support and load purposes.
- Lateral Files:
  - with solid spacer are not intended for use with a knife edge Adaptable worksurface due to dimensional differences.
  - without spacer with finished or unfinished top may be used in a slip-fit or nested Adaptable worksurface application.
  - without spacer are for use with edgeband Adaptable worksurface only; not intended for use with knife edge due to dimensional differences.

## Specification Tips, cont.

- Counterweight:
  - may be used in lateral files with or without a separately specified finished back.
  - is required in freestanding lateral files.
  - is not needed when two or more units are attached to a Compose Wood Common/ Continuous Storage Top or are ganged together with attachment hardware.
  - is not required in a panel mounted application when lateral file is attached to an Adaptable worksurface.
- Stack-on Storage:
  - may be used with 1H or 2H lateral file
  - lateral file and stack-on to be same width
  - not for use with 3H lateral file
- Cushion may be separately specified; recommended for use with a 1H lateral file.

## To Order, Specify:

- Product number, including:

### 1 Pull Options:

- 6** Patterns
- 7** Crescent
- 8** Linear
- 9** Classic
- K** Aluminum J-Pull

### 2 Base/Leg Options:

- E** Side Panel Base
- L** Plinth Base/Plastic Edge, add **\$448.21** list.
- P** Chamfer Leg, add **\$146.32** list.

### 3 Spacer Options:

- F** Floating Spacer/finished top 18”(457mm) deep, add **\$206.27** list.  
24”(610mm) deep, add **\$227.79** list.
- L** Solid Spacer/Plastic Edge/unfinished top, add **\$286.96** list.
- U** No Spacer/unfinished top
- N** No Spacer/finished top

### 4 Counterweight Option:

- Y** Yes, add **\$89.64** list.
- N** No

- Case laminate surface color.
- Base/Leg trim color.  
Side Panel Base (E) - (No finish specification.)  
Plinth Base (L) - Edge trim color.  
Chamfer (P) - Trim color.
- Spacer trim color.  
Floating Spacer (F) - Trim color.  
Solid Spacer (L) - Edge trim color.
- Lock plug trim color.
- Aluminum J-Pull trim color, if applicable.
- Laminate case edge trim color.

# Lateral Files

Actual Height No Spacer	Actual Height w/Spacer	Actual Depth Inset Back*	Actual Width	Pull	Number	① ② ③ ④	Laminate A	B
<b>1H</b>								
14.8" (376mm)	16.0" (406mm)	16.93" (430mm)	29.88" (759mm)	7,8,9	BZL1-1830-LLB	■ ■ L ■ ■	\$1763.53	\$1869.61
				K	BZL1-1830-LLBK	L ■ ■	1880.09	1986.17
				6	BZL1-1830-LLB6	L ■ ■	1862.19	1968.27
14.8" (376mm)	16.0" (406mm)	16.93" (430mm)	35.88" (911mm)	7,8,9	BZL1-1836-LLB	■ ■ L ■ ■	\$1950.13	\$2056.21
				K	BZL1-1836-LLBK	L ■ ■	2066.69	2172.77
				6	BZL1-1836-LLB6	L ■ ■	2048.79	2154.87
14.8" (376mm)	16.0" (406mm)	22.93" (582mm)	29.88" (759mm)	7,8,9	BZL1-2430-LLB	■ ■ L ■ ■	\$1915.42	\$2021.50
				K	BZL1-2430-LLBK	L ■ ■	2031.98	2138.06
				6	BZL1-2430-LLB6	L ■ ■	2014.08	2120.16
14.8" (376mm)	16.0" (406mm)	22.93" (582mm)	35.88" (911mm)	7,8,9	BZL1-2436-LLB	■ ■ L ■ ■	\$2102.02	\$2208.10
				K	BZL1-2436-LLBK	L ■ ■	2218.58	2324.66
				6	BZL1-2436-LLB6	L ■ ■	2200.68	2306.76
<b>1.5H</b>								
20.9" (531mm)	22.0" (559mm)	16.93" (430mm)	29.88" (759mm)	7,8,9	BZLA-1830-LLB	■ ■ L ■ ■	\$2259.31	\$2405.10
				K	BZLA-1830-LLBK	L ■ ■	2492.46	2638.25
				6	BZLA-1830-LLB6	L ■ ■	2456.61	2602.40
20.9" (531mm)	22.0" (559mm)	16.93" (430mm)	35.88" (911mm)	7,8,9	BZLA-1836-LLB	■ ■ L ■ ■	\$2502.43	\$2648.22
				K	BZLA-1836-LLBK	L ■ ■	2735.58	2881.37
				6	BZLA-1836-LLB6	L ■ ■	2699.73	2845.52
20.9" (531mm)	22.0" (559mm)	22.93" (582mm)	29.88" (759mm)	7,8,9	BZLA-2430-LLB	■ ■ L ■ ■	\$2442.80	\$2588.59
				K	BZLA-2430-LLBK	L ■ ■	2675.95	2821.74
				6	BZLA-2430-LLB6	L ■ ■	2640.10	2785.89
20.9" (531mm)	22.0" (559mm)	22.93" (582mm)	35.88" (911mm)	7,8,9	BZLA-2436-LLB	■ ■ L ■ ■	\$2685.92	\$2831.71
				K	BZLA-2436-LLBK	L ■ ■	2919.07	3064.86
				6	BZLA-2436-LLB6	L ■ ■	2883.22	3029.01
<b>2H</b>								
26.9" (683mm)	28.0" (711mm)	16.93" (430mm)	29.88" (759mm)	7,8,9	BZL2-1830-LLB	■ ■ L ■ ■	\$2422.18	\$2566.64
				K	BZL2-1830-LLBK	L ■ ■	2655.33	2799.79
				6	BZL2-1830-LLB6	L ■ ■	2619.48	2763.94
26.9" (683mm)	28.0" (711mm)	16.93" (430mm)	35.88" (911mm)	7,8,9	BZL2-1836-LLB	■ ■ L ■ ■	\$2659.65	\$2804.11
				K	BZL2-1836-LLBK	L ■ ■	2892.80	3037.26
				6	BZL2-1836-LLB6	L ■ ■	2856.95	3001.41
26.9" (683mm)	28.0" (711mm)	22.93" (582mm)	29.88" (759mm)	7,8,9	BZL2-2430-LLB	■ ■ L ■ ■	\$2602.76	\$2747.22
				K	BZL2-2430-LLBK	L ■ ■	2835.91	2980.37
				6	BZL2-2430-LLB6	L ■ ■	2800.06	2944.52
26.9" (683mm)	28.0" (711mm)	22.93" (582mm)	35.88" (911mm)	7,8,9	BZL2-2436-LLB	■ ■ L ■ ■	\$2840.23	\$2984.69
				K	BZL2-2436-LLBK	L ■ ■	3073.38	3217.84
				6	BZL2-2436-LLB6	L ■ ■	3037.53	3181.99
<b>3H</b>								
38.9" (988mm)	40.1" (1019mm)	16.93" (430mm)	29.88" (759mm)	7,8,9	BZL3-1830-LLB	■ ■ L ■ N	\$3351.39	\$3584.58
				K	BZL3-1830-LLBK	L ■ N	3701.13	3934.32
				6	BZL3-1830-LLB6	L ■ N	3647.31	3880.50
38.9" (988mm)	40.1" (1019mm)	16.93" (430mm)	35.88" (911mm)	7,8,9	BZL3-1836-LLB	■ ■ L ■ N	\$4020.03	\$4253.22
				K	BZL3-1836-LLBK	L ■ N	4369.77	4602.96
				6	BZL3-1836-LLB6	L ■ N	4315.95	4549.14
38.9" (988mm)	40.1" (1019mm)	22.93" (582mm)	29.88" (759mm)	7,8,9	BZL3-2430-LLB	■ ■ L ■ N	\$4337.25	\$4570.44
				K	BZL3-2430-LLBK	L ■ N	4686.99	4920.18
				6	BZL3-2430-LLB6	L ■ N	4633.17	4866.36
38.9" (988mm)	40.1" (1019mm)	22.93" (582mm)	35.88" (911mm)	7,8,9	BZL3-2436-LLB	■ ■ L ■ N	\$5005.89	\$5239.08
				K	BZL3-2436-LLBK	L ■ N	5355.63	5588.82
				6	BZL3-2436-LLB6	L ■ N	5301.81	5535.00

\*Inset Back Unfinished

# Open Shelf Lateral File

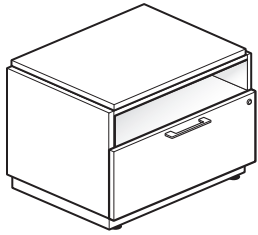

BZLV

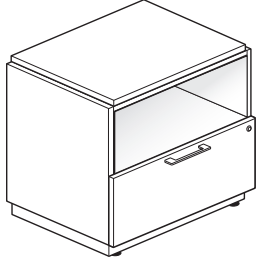

BZLZ

**Note:** Refer to features for file drawer capabilities.

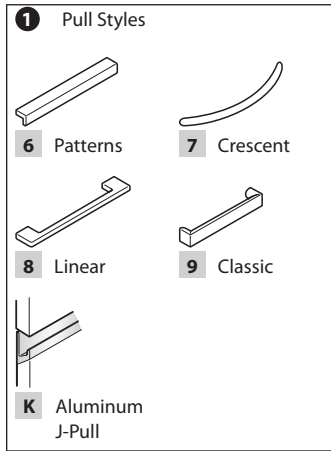

## Features

- Open Shelf Lateral Files include:
  - Fixed shelf with finished interior.
  - Base or leg and drawer pull options.
  - Floating spacer option has a finished top.
  - Solid spacer option has an unfinished top.
  - Black miterfold drawer interior.
  - Laminate case with back and laminate drawer fronts. Laminate case edgeband matches laminate drawer front edgeband.
- Open Shelf interior dimensions:
  - 1.5H = 5.3”(135mm) high
  - 2H = 11.3”(287mm) high
  - 30”(762mm) wide = 28.38”(721mm)
  - 36”(914mm) wide = 34.38”(873mm)
- File drawer includes integrated file hanging system and two file hangar bars.
  - 18”(457mm) D x 30”(762mm) W: letter front-to-back
  - 18”(457mm) D x 36”(914mm) W: letter/legal front-to-back
  - 24”(610mm) D x 30”(762mm) W: letter front-to-back or legal side-to-side
  - 24”(610mm) D x 36”(914mm) W: letter/legal front-to-back or legal side-to-side
- Note - The lateral file drawer will accommodate a Pendaflex file folder without tabs. File drawer will not close if tabs are used. Exception: 2H unit with Side Panel Base, option (E), will accommodate tabs.
- All drawers have full extension slides.
- Standard with lock; lock plugs available in chrome or black.
- For lock options, refer to Lock Program section of the Accessories Price List.
- Drawer Pull Options:
  - Crescent (7), Linear (8) and Classic (9) pulls standard in Brushed Nickel finish (no specification required).
  - Patterns (6) pull standard in Anodized Aluminum finish (no specification required).
  - Integrated Aluminum J-Pull (K); aluminum finger pull requires trim color.
- Base/Leg Options:
  - Side Panel Base (E); sides/front extend to floor; side panels are part of case.
  - Plinth Base with plastic edge (L); requires edge trim color.
  - Chamfer leg (P); requires trim color.
- Glide height adjustment ranges:
  - Chamfer leg - 1.25”(32mm)
  - Side Panel Base/Plinth Base - 2”(51mm)
- Spacer Options:
  - Floating Spacer (F); requires trim color (finished top).
  - Solid Spacer with plastic edge (L); requires edge trim color (unfinished top).
  - No Spacer (U); no surface specification required (unfinished top).
  - No Spacer (N); no surface specification required (finished top).
- Counterweight Option:
  - Yes, counterweight is factory installed.
  - No, no counterweight.
- Floating and solid spacers are 1.19”(30mm) high.
- Case (with/without optional Counterweight) ships assembled; Spacer and Plinth Base/Legs require field installation.

## Specification Tips

- Finished Back is separately specified when lateral file back is exposed.
- Open shelf lateral file requires a solid or floating spacer for a 29”(737mm) high Adaptable worksurface.
- For panel mounted applications; separately specify appropriate attachment brackets for support and load purposes.
- Open Shelf Lateral Files:
  - with solid spacer are not intended for use with a knife edge Adaptable worksurface due to dimensional differences
  - without spacer with finished or unfinished top may be used in a slip-fit or nested Adaptable worksurface application
  - without spacer are for use with edgeband Adaptable worksurface only; not intended for use with knife edge due to dimensional differences

## Specification Tips, cont.

- Counterweight:
  - may be used in lateral files with or without a separately specified finished back.
  - is required in a freestanding open shelf lateral file.
  - is not needed when two or more units are attached to a Compose Common/Continuous Storage Top or are ganged together with attachment hardware.
  - is not required in a panel mounted application when an open shelf lateral file is attached to an Adaptable worksurface.
- Stack-on Storage:
  - may be used with open shelf lateral file;
  - lateral file and stack-on to be same width.
- Refer to Specification Guide for planning information.

## To Order, Specify:

- 1) Product number, including:

### 1 Pull Options:

- 6** Patterns
- 7** Crescent
- 8** Linear
- 9** Classic
- K** Aluminum J-Pull

### 2 Base/Leg Options:

- E** Side Panel Base
- L** Plinth Base/Plastic Edge, add **\$448.21** list.
- P** Chamfer Leg, add **\$146.32** list.

### 3 Spacer Options:

- F** Floating Spacer/finished top 18”(457mm) deep, add **\$206.27** list.  
24”(610mm) deep, add **\$227.79** list.
- L** Solid Spacer/Plastic Edge/unfinished top, add **\$286.96** list.
- U** No Spacer/unfinished top
- N** No Spacer/finished top

### 4 Counterweight Option:

- Y** Yes, add **\$89.64** list.
- N** No

- 2) Case laminate surface color.
- 3) Base/Leg trim color.  
Side Panel Base (E) - (No finish specification.)  
Plinth Base (L) - Edge trim color.  
Chamfer (P) - Trim color.
- 4) Spacer trim color.  
Floating Spacer (F) - Trim color.  
Solid Spacer (L) - Edge trim color.
- 5) Lock plug trim color.
- 6) Aluminum J-Pull trim color, if applicable.
- 7) Laminate case edge trim color.

# Open Shelf Lateral File

Actual Height No Spacer	Actual Height w/Spacer	Actual Depth Inset Back*	Actual Width	Pull	Number	① ② ③ ④	Laminate A	B
<b>1.5H</b>								
20.9" (531mm)	22.0" (559mm)	16.93" (430mm)	29.88" (759mm)	7,8,9	BZLV-1830-LLB	■ ■ L ■ ■	\$1894.78	\$2009.13
				K	BZLV-1830-LLBK	■ L ■ ■	2011.34	2125.69
				6	BZLV-1830-LLB6	■ L ■ ■	1993.44	2107.79
20.9" (531mm)	22.0" (559mm)	16.93" (430mm)	35.88" (911mm)	7,8,9	BZLV-1836-LLB	■ ■ L ■ ■	\$2081.92	\$2196.27
				K	BZLV-1836-LLBK	■ L ■ ■	2198.48	2312.83
				6	BZLV-1836-LLB6	■ L ■ ■	2180.58	2294.93
20.9" (531mm)	22.0" (559mm)	22.93" (582mm)	29.88" (759mm)	7,8,9	BZLV-2430-LLB	■ ■ L ■ ■	\$2034.07	\$2148.42
				K	BZLV-2430-LLBK	■ L ■ ■	2150.63	2264.98
				6	BZLV-2430-LLB6	■ L ■ ■	2132.73	2247.08
20.9" (531mm)	22.0" (559mm)	22.93" (582mm)	35.88" (911mm)	7,8,9	BZLV-2436-LLB	■ ■ L ■ ■	\$2221.21	\$2335.56
				K	BZLV-2436-LLBK	■ L ■ ■	2337.77	2452.12
				6	BZLV-2436-LLB6	■ L ■ ■	2319.87	2434.22
<b>2H</b>								
26.9" (683mm)	28.0" (711mm)	16.93" (430mm)	29.88" (759mm)	7,8,9	BZLZ-1830-LLB	■ ■ L ■ ■	\$2074.03	\$2188.38
				K	BZLZ-1830-LLBK	■ L ■ ■	2190.59	2304.94
				6	BZLZ-1830-LLB6	■ L ■ ■	2172.69	2287.04
26.9" (683mm)	28.0" (711mm)	16.93" (430mm)	35.88" (911mm)	7,8,9	BZLZ-1836-LLB	■ ■ L ■ ■	\$2261.17	\$2375.52
				K	BZLZ-1836-LLBK	■ L ■ ■	2377.73	2492.08
				6	BZLZ-1836-LLB6	■ L ■ ■	2359.83	2474.18
26.9" (683mm)	28.0" (711mm)	22.93" (582mm)	29.88" (759mm)	7,8,9	BZLZ-2430-LLB	■ ■ L ■ ■	\$2213.32	\$2327.67
				K	BZLZ-2430-LLBK	■ L ■ ■	2329.88	2444.23
				6	BZLZ-2430-LLB6	■ L ■ ■	2311.98	2426.33
26.9" (683mm)	28.0" (711mm)	22.93" (582mm)	35.88" (911mm)	7,8,9	BZLZ-2436-LLB	■ ■ L ■ ■	\$2400.46	\$2514.81
				K	BZLZ-2436-LLBK	■ L ■ ■	2517.02	2631.37
				6	BZLZ-2436-LLB6	■ L ■ ■	2499.12	2613.47

\*Unfinished Inset Back

# Combination Unit

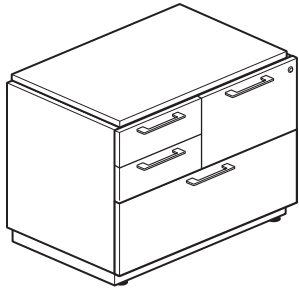

BZLB

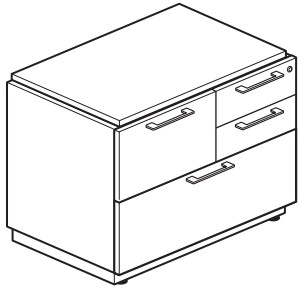

BZLC

**Note:** Graphics shown with solid spacer and plinth base. See features for file drawer capabilities.

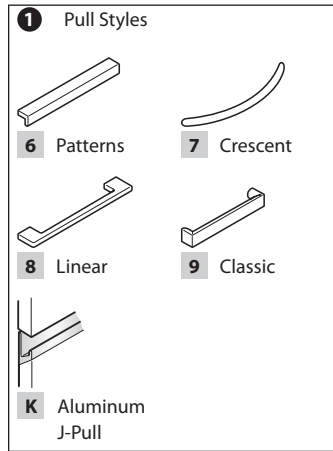

## Features

- Combination Units include:
  - Base or leg and drawer pull options.
  - Floating spacer option has a finished top.
  - Solid spacer option has an unfinished top.
  - Black miterfold drawer interiors.
  - Laminate case with back and laminate drawer fronts. Laminate case edgeband matches laminate drawer front edgeband.
- Box drawers include one black plastic divider each.
- One black plastic pencil tray included with Box/Box drawer.
- File drawer includes integrated file hanging system and two file hangar bars per drawer.
  - Pedestal drawer: Letter: Front-to-back
  - 18”(457mm) D x 36”(914mm) W: letter/legal front-to-back
  - 24”(610mm) D x 36”(914mm) W: letter/legal front-to-back or legal side-to-side
- Note - The upper file drawer will accommodate Pendaflex file folders with tabs. The lower lateral file drawer will accommodate a Pendaflex file folder without tabs. Lower file drawer will not close if tabs are used.
- All drawers have full extension slides.
- Standard with single lock; lock plugs available in chrome or black.
- For lock options, refer to Lock Program section of the Accessories Price List.
- Drawer pull options:
  - Crescent (7), Linear (8) and Classic (9) pulls are Brushed Nickel finish (no specification required).
  - Patterns (6) pull standard in Anodized Aluminum finish (no specification required).
  - Integrated Aluminum J-Pull (K); aluminum finger pull requires trim color.
- Base/Leg Options:
  - Side Panel Base (E); sides/front extend to floor; side panels are part of case.
  - Plinth Base with plastic edge (L); requires edge trim color.
  - Chamfer leg (P); requires trim color.
- Glide height adjustment ranges:
  - Chamfer leg - 1.25”(32mm)
  - Side Panel Base/Plinth Base - 2”(51mm)
- Spacer Options:
  - Floating Spacer (F); requires trim color.
  - Solid Spacer with plastic edge (L); requires edge trim color.
  - No Spacer (U); no surface specification required (unfinished top).
  - No Spacer (N); no surface specification required (finished top).
- Counterweight Option:
  - Yes, counterweight is factory installed.
  - No, no counterweight (attached pedestal only).
- Floating and solid spacers are 1.19”(30mm) high.
- Orientation of box/box drawers is represented by one of the following letters as the fourth-digit.
  - (C) right-hand side of unit.
  - (B) left-hand side of unit.
- Case (with/without optional Counterweight) ships assembled; Spacer and Base/Legs require field installation.

## Specification Tips

- Finished back is separately specified when combination unit back is exposed.
- Requires a solid or floating spacer for a 29”(737mm) high Adaptable worksurface application.
- For panel mounted applications; separately specify appropriate attachment brackets for support and load purposes.
- Combination Unit:
  - with solid spacer is not intended for use with a knife edge Adaptable worksurface due to dimensional differences.
  - without spacer with finished or unfinished top may be used in a slip-fit or nested Adaptable worksurface application.
  - without spacer is for use with edgeband Adaptable worksurface only; not intended for use with knife edges due to dimensional differences.
- Orientation of drawer configuration is not field changeable.
- Counterweight:
  - may be used in combination unit with or without a separately specified finished back.

## Specification Tips, cont.

- is required in a freestanding combination unit.
- is not needed when two or more units are attached to a Compose Common/Continuous Storage Top or are ganged together with attachment hardware.
- is not required in a panel mounted application when combination unit is attached to an Adaptable worksurface.
- Stack-on Storage:
  - may be used with combination units; combination unit and stack-on unit to be same width.
- Refer to Specification Guide for planning information.

## To Order, Specify:

- 1) Product number, including:

### 1 Pull Options:

- 6** Patterns
- 7** Crescent
- 8** Linear
- 9** Classic
- K** Aluminum J-Pull

### 2 Base/Leg Options:

- E** Side Panel Base
- L** Plinth Base/Plastic Edge, add **\$448.21** list.
- P** Chamfer Leg, add **\$146.32** list.

### 3 Spacer Options:

- F** Floating Spacer/finished top 18”(457mm) deep, add **\$206.27** list, 24”(610mm) deep, add **\$227.79** list.
- L** Solid Spacer/Plastic Edge/unfinished top, add **\$286.96** list.
- U** No Spacer/unfinished top
- N** No Spacer/finished top

### 4 Counterweight Option:

- Y** Yes, add **\$89.64** list.
- N** No

- 2) Case laminate surface color.
- 3) Base/Leg trim color.
  - Side Panel Base (E) - (No finish specification.)
  - Plinth Base (L) - Edge trim color.
  - Chamfer (P) - Trim color.
- 4) Spacer trim color.
  - Floating Spacer (F) - Trim color.
  - Solid Spacer (L) - Edge trim color.
- 5) Lock plug trim color.
- 6) Aluminum J-Pull trim color, if applicable.
- 7) Laminate case edge trim color.

## Combination Unit

Actual Height No Spacer	Actual Height w/Spacer	Actual Depth Inset Back*	Actual Width	Pull	Number	① ② ③ ④	Laminate A	B
<b>Right Hand</b>								
26.9"(683mm)	28.0"(711mm)	16.93"(430mm)	35.875"(911mm)	7,8,9	BZLC-1836-LLB	■ ■ L ■ ■	\$2312.35	\$2462.36
				K	BZLC-1836-LLBK	L ■ ■	2662.09	2812.10
				6	BZLC-1836-LLB6	L ■ ■	2608.27	2758.28
26.9"(683mm)	28.0"(711mm)	22.93"(582mm)	35.875"(911mm)	7,8,9	BZLC-2436-LLB	■ ■ L ■ ■	\$2350.77	\$2500.78
				K	BZLC-2436-LLBK	L ■ ■	2700.51	2850.52
				6	BZLC-2436-LLB6	L ■ ■	2646.69	2796.70
<b>Left Hand</b>								
26.9"(683mm)	28.0"(711mm)	16.93"(430mm)	35.875"(911mm)	7,8,9	BZLB-1836-LLB	■ ■ L ■ ■	\$2312.35	\$2462.36
				K	BZLB-1836-LLBK	L ■ ■	2662.09	2812.10
				6	BZLB-1836-LLB6	L ■ ■	2608.27	2758.28
26.9"(683mm)	28.0"(711mm)	22.93"(582mm)	35.875"(911mm)	7,8,9	BZLB-2436-LLB	■ ■ L ■ ■	\$2350.77	\$2500.78
				K	BZLB-2436-LLBK	L ■ ■	2700.51	2850.52
				6	BZLB-2436-LLB6	L ■ ■	2646.69	2796.70

\*Unfinished Inset Back

# Lateral File/Storage Accessories

## File/Storage Cushion

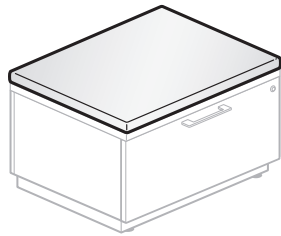

BZSC-F

Actual Height	Nominal Depth	Actual Width	Number ①	Fabric Grade				
				A	B	C	D	E
1.25"(32mm)	18"(457mm)	29.88"(759mm)	BZSC-1830-F	\$ 848.25	\$1021.48	\$1164.51	\$1319.29	\$1472.03
	24"(610mm)		BZSC-2430-F	990.96	1180.66	1326.16	1483.51	1638.81
1.25"(32mm)	18"(457mm)	35.88"(911mm)	BZSC-1836-F	\$ 866.31	\$1060.54	\$1206.63	\$1364.77	\$1520.81
	24"(610mm)		BZSC-2436-F	1009.02	1219.72	1368.28	1528.99	1687.59

### Features

- Includes one 1.25"(32mm) thick cushion with removable attachment.
- File/Storage cushions are dimensioned to accommodate units with insert back (S) or separately specified proud finished back (A).
- Field installed.
- COM yardage:  
 18"(457mm) x 30"(762mm) - 1.9 yards  
 18"(457mm) x 36"(914mm) - 2.2 yards  
 24"(610mm) x 30"(762mm) - 2.5 yards  
 24"(610mm) x 36"(914mm) - 2.6 yards

### To Order, Specify:

- 1) Product number, including:

#### ① Unit Back Option:

- A** Proud Finished Back
- S** Inset Unfinished Back

- 2) Fabric and color.

### Specification Tips

- For use with Compose Storage.
- File/Storage Cushion:
  - Must be used on top of attached Compose Storage top.
  - May not be placed directly on top of spacers or finished/unfinished tops.
- Not for use with X Series or V Series storage.
- Separately specified storage top is required for use with Lateral File cushion.
- Refer to Specification Guide for planning information.

## Storage-to-Panel Bracket

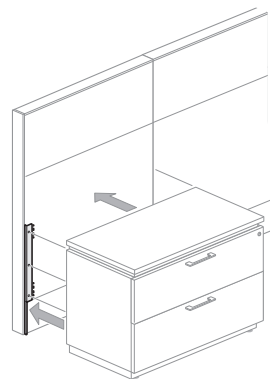

BZBG

Description	Number	Trim	
		A	B
2H storage	BZBG-0002	\$151.85	\$160.82
3H storage/ full height storage	BZBG-0003	151.85	160.82

### Features

- Includes one bracket and mounting screws.
- Installs into panel frame attachment slots and attaches to back side of lower storage or full height storage.
- Non-handed.
- **Installation requires field drilling which will deface storage unit or finished back.**

### To Order, Specify:

- 1) Product number.
- 2) Trim color.

### Specification Tips

- For use with 2H- and 3H storage units and full height storage with Chamfer leg, plinth or side panel bases; height specific product number.
- Worksurface and lower storage unit must be same nominal depth.
- Designed for use with edgeband worksurfaces.
- **Not for use with:**
  - Knife edge worksurfaces
  - X Series or V Series storage
- For use with lower storage with unfinished insert back or separately specified finished proud back.
- Refer to Specification Guide for planning information.

## Lateral File Hanging Bar

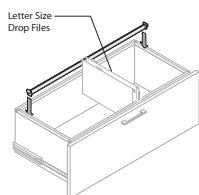

BZAH

Width	Number	Price
30"(762mm)	BZAH-0030	\$23.30
36"(914mm)	BZAH-0036	26.89

### Features

- Includes one side-to-side hanging bar.
- Allows for side-to-side letter filing in lateral file drawer.
- Standard in black finish color only.

### To Order, Specify:

- 1) Product number.  
(No finish specification required.)



# Individual/Common Storage Tops

Nominal Depth	Actual Depth Proud	Actual Depth Inset	Nominal Width	Number ①	Laminate A	B
18"(457mm)	17.68"(449mm)	16.93"(430mm)	16"(406mm)	BZTR-1816-LJS S	\$161.40	\$261.84
			30"(762mm)	BZTR-1830-LJS S	219.15	319.59
			36"(914mm)	BZTR-1836-LJS S	243.90	344.34
			60"(1524mm)	BZTR-1860-LJS S	342.90	443.34
			66"(1676mm)	BZTR-1866-LJS S	367.65	468.09
			72"(1829mm)	BZTR-1872-LJS S	392.40	492.84
24"(610mm)	23.68"(601mm)	22.93"(583mm)	16"(406mm)	BZTR-2416-LJS S	\$179.67	\$280.11
			30"(762mm)	BZTR-2430-LJS S	249.60	350.04
			36"(914mm)	BZTR-2436-LJS S	280.44	380.88
			60"(1524mm)	BZTR-2460-LJS S	403.80	504.24
			66"(1676mm)	BZTR-2466-LJS S	434.64	535.08
			72"(1829mm)	BZTR-2472-LJS S	465.48	565.92
30"(762mm)	29.68"(754mm)	28.93"(735mm)	16"(406mm)	BZTR-3016-LJS S	\$197.94	\$298.38
36"(914mm)	35.36"(898mm)	33.86"(860mm)	30"(762mm)	BZTR-3630-LJS S	\$310.50	\$410.94
			36"(914mm)	BZTR-3636-LJS S	353.52	453.96
			60"(1524mm)	BZTR-3660-LJS S	525.60	626.04
			66"(1676mm)	BZTR-3666-LJS S	568.62	669.06
			72"(1829mm)	BZTR-3672-LJS S	611.64	712.08
			48"(1219mm)	47.36"(1203mm)	45.86"(1165mm)	30"(762mm)
48"(1219mm)	47.36"(1203mm)	45.86"(1165mm)	36"(914mm)	BZTR-4836-LJS S	426.60	527.04
			60"(1524mm)	BZTR-4860-LJS S	647.40	747.84
			66"(1676mm)	BZTR-4866-LJS S	702.60	803.04
			72"(1829mm)	BZTR-4872-LJS S	757.80	858.24

**Individual/Common Storage Tops — For use with Proud Finished Back and Inset Unfinished Back Units**

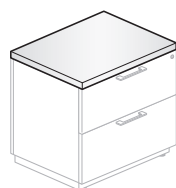

BZTR-1830



BZTR-1860

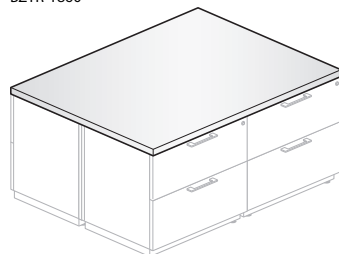

BZTR-3660

**Features**

- Includes 1.19"(30mm) thick Individual or Common Storage Top and attachment hardware.
- Laminate surface with 3mm edgeband on front and back edge; 1mm edgeband on sides.
- Available for storage applications with inset unfinished back or separately specified proud finished back; specify accordingly.
- Common storage tops require all storage units to have the same back option; inset unfinished backs or separately specified proud finished backs.
- Storage tops are dimensioned to accommodate storage units with inset back or separately specified proud finished attached back:
  - Specify "S" to accommodate storage unit with inset unfinished back.
  - Specify "A" to accommodate storage units with separately specified proud finished back.

**Specification Tips**

- Dimensioned for use with Compose Storage only; freestanding application.
- Individual Storage Top for use with a single pedestal, a single storage unit, a single file; lateral, combination or open shelf.
- Common Storage Top is for use with two side-by-side lower storage units in a single row; application may be mirrored for a back-to-back application. For use with storage units or files; lateral, combination or open shelf.
- All storage units must have the same back option in a common storage top application.
- May be used on lower storage with or without spacer.
- Refer to Specification Guide for planning information.

**To Order, Specify:**

- 1) Product number, including:

**① Unit Back Option:**

- A** Proud Finished Back
- S** Inset Unfinished Back

- 2) Laminate surface color.
- 3) Edge trim color.

# Continuous Storage Tops

Nominal Depth	Actual Depth Proud	Actual Depth Inset	Nominal Width	Number <sup>①</sup>	Laminate A	B
<b>Side-by-Side</b>						
18"(457mm)	17.68"(449mm)	16.93"(430mm)	62"(1575mm)	BZTB-1862-LJS S	\$351.15	\$451.59
			68"(1727mm)	BZTB-1868-LJS S	375.90	476.34
			76"(1930mm)	BZTB-1876-LJS S	408.90	509.34
			88"(2235mm)	BZTB-1888-LJS S	458.40	558.84
			90"(2286mm)	BZTB-1890-LJS S	466.65	567.09
			96"(2438mm)	BZTB-1896-LJS S	491.40	591.84
			102"(2591mm)	BZTB-18A2-LJS S	516.15	616.59
			108"(2743mm)	BZTB-18A8-LJS S	540.90	641.34
24"(610mm)	23.68"(601mm)	22.93"(582mm)	62"(1575mm)	BZTB-2462-LJS S	\$418.14	\$518.58
			68"(1727mm)	BZTB-2468-LJS S	448.98	549.42
			76"(1930mm)	BZTB-2476-LJS S	488.07	588.51
			88"(2235mm)	BZTB-2488-LJS S	549.75	650.19
			90"(2286mm)	BZTB-2490-LJS S	558.00	658.44
			96"(2438mm)	BZTB-2496-LJS S	588.84	689.28
			102"(2591mm)	BZTB-24A2-LJS S	619.68	720.12
			108"(2743mm)	BZTB-24A8-LJS S	650.52	750.96

**Continuous Storage Tops — For use with Proud Finished Back and Inset Unfinished Back Units**

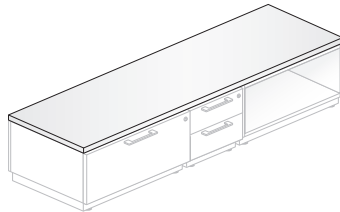

BZTB-1862

**Continuous Storage Top Accommodates**

Width	Storage Combined Widths
62"	16"/16"/30"
68"	16"/16"/36"
76"	16"/30"/30"
88"	16"/36"/36"
90"	30"/30"/30"
96"	30"/30"/36"
102"	36"/36"/30"
108"(A8)	36"/36"/36"

**Features**

- Includes 1.19"(30mm) thick Continuous Storage Top and attachment hardware.
- Laminate surface with 3mm edgeband on front and back edge; 1mm edgeband on sides.
- Available for storage applications with inset unfinished back or separately specified proud finished back; specify accordingly.
- Continuous storage tops require all storage units to have the same back option; inset unfinished backs or separately specified proud finished backs.

**Specification Tips**

- Dimensioned for use with Compose Storage only; freestanding application. For use with pedestal, storage unit or file; lateral, combination or open shelf.
- Continuous Storage Top is for use with three side-by-side lower storage units in a single row application.
- Storage tops are dimensional to accommodate storage units with an inset unfinished back or separately specified proud finished attached back.
  - Specify "S" to accommodate storage unit with inset unfinished back.
  - Specify "A" to accommodate storage unit with separately specified proud finished back.
- All storage units must have the same back option in a continuous storage top application.
- May be used on lower storage with or without spacer.
- Refer to Specification Guide for additional planning information.

**To Order, Specify:**

- 1) Product number, including:

**① Unit Back Option:**

- A** Proud Finished Back
- S** Inset Unfinished Back

- 2) Laminate surface color.
- 3) Edge trim color.

## Off-Modular Storage Tops

Nominal Depth	Actual Depth Proud	Actual Depth Inset	Width	Number ①	Laminate A	B
18"(457mm)	17.68"(449mm)	16.93"(430mm)	30"(762mm)	BZTM-1830-LJS S	\$219.15	\$319.59
			36"(914mm)	BZTM-1836-LJS S	243.90	344.34
			42"(1067mm)	BZTM-1842-LJS S	268.65	369.09
			48"(1219mm)	BZTM-1848-LJS S	293.40	393.84
			54"(1372mm)	BZTM-1854-LJS S	318.15	418.59
24"(610mm)	23.68"(601mm)	22.93"(582mm)	30"(762mm)	BZTM-2430-LJS S	\$249.60	\$350.04
			36"(914mm)	BZTM-2436-LJS S	280.44	380.88
			42"(1067mm)	BZTM-2442-LJS S	311.28	411.72
			48"(1219mm)	BZTM-2448-LJS S	342.12	442.56
			54"(1372mm)	BZTM-2454-LJS S	372.96	473.40
36"(914mm)	35.36"(898mm)	33.86"(860mm)	30"(762mm)	BZTM-3630-LJS S	\$310.50	\$410.94
			36"(914mm)	BZTM-3636-LJS S	353.52	453.96
			42"(1067mm)	BZTM-3642-LJS S	396.54	496.98
			48"(1219mm)	BZTM-3648-LJS S	439.56	540.00
			54"(1372mm)	BZTM-3654-LJS S	482.58	583.02
48"(1219mm)	47.36"(1203mm)	45.86"(1165mm)	30"(762mm)	BZTM-4830-LJS S	\$371.40	\$471.84
			36"(914mm)	BZTM-4836-LJS S	426.60	527.04
			42"(1067mm)	BZTM-4842-LJS S	481.80	582.24
			48"(1219mm)	BZTM-4848-LJS S	537.00	637.44
			54"(1372mm)	BZTM-4854-LJS S	592.20	692.64

### For use in off-modular Proud Finished Back and Inset Unfinished Back Units

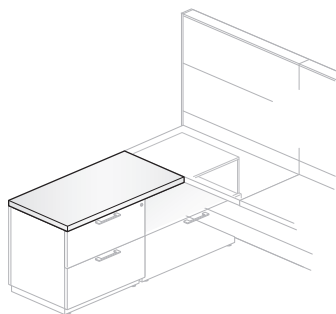

BZTM-1836

### Features

- Includes 1.19"(30mm) thick Off-Modular Storage Top and attachment hardware.
- Laminate surface with 3mm edgeband on front and back edge; 1mm edgeband on sides.
- Available for nested storage applications with inset unfinished backs or separately specified proud finished backs; specify accordingly.
- Off-Modular storage tops require all storage units have the same back option; inset unfinished backs or a separately specified proud finished backs.

### Specification Tips

- Dimensioned for use with Compose Storage only. For use with storage units or files; lateral, combination or open shelf.
- Designed for a nested storage application; a portion of the lower storage application is nested beneath a 1.19"(30mm) thick panel mounted Adaptable worksurface.
- Off-Modular Storage Top is for use with:
  - two side-by-side lower storage units in a single row; one storage unit is nested beneath a panel mounted adaptable worksurface.
  - two side-by-side lower storage units in a mirrored application; two storage units are nested beneath a panel mounted adaptable worksurface.
- Off-Modular Storage tops are dimensioned to accommodate storage units with an inset unfinished back or separately specified proud finished attached back:
  - Specify "S" to accommodate storage unit with inset unfinished back.
  - Specify "A" to accommodate storage unit with separately specified proud finished back.
- All storage units must have the same back option in an off-modular storage top application.
- Refer to Specification Guide for planning information.

### To Order, Specify:

- 1) Product number, including:

#### ① Unit Back Option:

- A** Proud Finished Back
- S** Inset Unfinished Back

- 2) Laminate surface color.
- 3) Edge trim color.

# Storage Unit with Doors

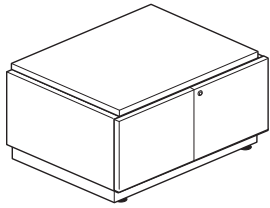

BZSS-LL1T

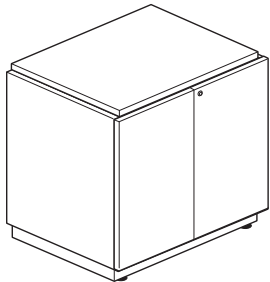

BZSS-LL2T

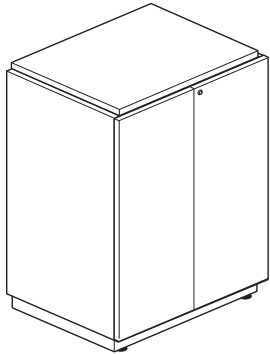

BZSS-LL3T

**Note:** Graphics shown with solid spacer and plinth base.

## Features

- Storage Units with doors include:
  - Standard with finished interior.
  - Base or leg options.
  - Floating spacer option has a finished top.
  - Solid spacer option has an unfinished top.
  - Laminate case with unfinished inset back and laminate touch-latch doors.
- Shelves are 0.75”(19mm) thick and adjust 1.26”(32mm) up or down only.
  - 1H: open interior storage.
  - 2H: one adjustable shelf.
  - 3H: two adjustable shelves.
- Interior height dimension is based upon leg/base option chosen; refer to Specification Guide.
- Base/Leg Options:
  - Side Panel Base (E); sides/front extend to floor; side panels are part of case.
  - Plinth Base with plastic edge (L); requires edge trim color.
  - Chamfer leg (P); requires trim color.
- Glide adjustment range:
  - Side Panel Base: 1”(25mm).
  - Plinth Base/Chamfer Leg: 1.25”(32mm).
- Lock plugs available in chrome or black.
- For lock options, refer to Lock Program section of the Accessories Price List.
- Spacer Options:
  - Floating Spacer (F); requires trim color (finished top).
  - Solid Spacer with plastic edge (L); requires edge trim color (unfinished top).
  - No Spacer (U); no surface specification required (unfinished top).
  - No Spacer (N); no surface specification required (finished top).
- Floating and solid spacers are 1.19”(30mm) high.
- Case ships assembled; Spacers and Base/Legs require field installation.

## Specification Tips

- Finished Back is separately specified when storage unit back is exposed.
- 2H storage unit requires a solid or floating spacer for a 29”(737mm) high Adaptable worksurface.
- For panel mounted applications; separately specify appropriate attachment brackets for support and load purposes.
- Storage Unit:
  - with solid spacer are not intended for use with a knife edge Adaptable worksurface due to dimensional differences.
  - without spacer with finished or unfinished top may be used in a slip-fit or nested Adaptable worksurface application.
  - without spacer are for use with edgeband Adaptable worksurface only; not intended for use with knife edge due to dimensional differences.
- Counterweight is not needed in a storage unit with doors.
- Side panel base option provides approximately 1.625”(41mm) additional interior storage capacity. Refer to Specification Guide for details.
- Stack-on Storage:
  - may be used with 1H or 2H storage unit; storage unit and stack-on to be same width.
  - not for use with 3H storage unit.
- Refer to Specification Guide for planning information.

## To Order, Specify:

1) Product number, including:

### 1 Base/Leg Options:

- E** Side Panel Base
- L** Plinth Base/Plastic Edge, add **\$448.21** list.
- P** Chamfer Leg, add **\$146.32** list.

### 2 Lock Options:

- L** Locking, add **\$190.26** list.
- N** Non-locking

### 3 Spacer Options:

- F** Floating Spacer/finished top 18”(457mm) deep, add **\$206.27** list. 24”(610mm) deep, add **\$227.79** list.
- L** Solid Spacer/Plastic Edge/unfinished top, add **\$286.96** list.
- U** No Spacer/unfinished top
- N** No Spacer/finished top

2) Case laminate surface color.

3) Base/Leg trim color.  
Side Panel Base (E) - (No finish specification.)  
Plinth Base (L) - Edge trim color.  
Chamfer (P) - Trim color.

4) Spacer trim color.  
Floating Spacer (F) - Trim color.  
Solid Spacer (L) - Edge trim color.

5) Lock plug trim color, if applicable.

6) Laminate case edge trim color.

## Storage Unit with Doors

Actual Height No Spacer	Actual Height w/Spacer	Actual Depth Inset Back*	Actual Width	Number	① ② ③	Laminate A	B
<b>1H</b>							
14.8"(376mm)	16.0"(406mm)	16.93"(430mm)	29.88"(759mm)	BZSS-1830-LL1T	■ ■ ■	\$1699.50	\$1835.46
			35.88"(911mm)	BZSS-1836-LL1T	■ ■ ■	1768.85	1904.81
		22.93"(582mm)	29.88"(759mm)	BZSS-2430-LL1T	■ ■ ■	1760.59	1896.55
			35.88"(911mm)	BZSS-2436-LL1T	■ ■ ■	1829.94	1965.90
<b>2H</b>							
26.9"(683mm)	28.0"(711mm)	16.93"(430mm)	29.88"(759mm)	BZSS-1830-LL2T	■ ■ ■	\$2248.33	\$2384.29
			35.88"(911mm)	BZSS-1836-LL2T	■ ■ ■	2317.68	2453.64
		22.93"(582mm)	29.88"(759mm)	BZSS-2430-LL2T	■ ■ ■	2309.42	2445.38
			35.88"(911mm)	BZSS-2436-LL2T	■ ■ ■	2378.77	2514.73
<b>3H</b>							
38.9"(988mm)	40.1"(1019mm)	16.93"(430mm)	29.88"(759mm)	BZSS-1830-LL3T	■ ■ ■	\$2886.76	\$3022.72
			35.88"(911mm)	BZSS-1836-LL3T	■ ■ ■	2956.11	3092.07
		22.93"(582mm)	29.88"(759mm)	BZSS-2430-LL3T	■ ■ ■	2947.85	3083.81
			35.88"(911mm)	BZSS-2436-LL3T	■ ■ ■	3017.20	3153.16

\*Unfinished Inset Back

# Storage Unit without Doors

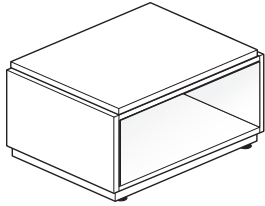

BZSN-LN1N

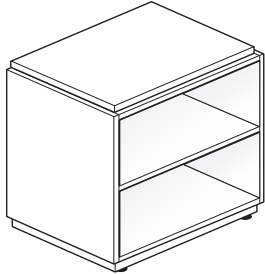

BZSN-LN2N

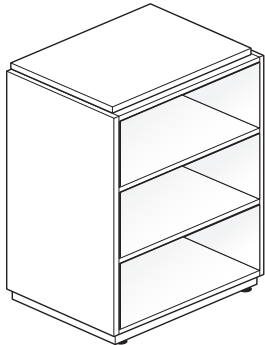

BZSN-LN3N

**Note:** Graphics shown with solid spacer and plinth base.

## Features

- Storage Units without doors include:
  - Standard with unfinished inset back.
  - Standard with finished interior.
  - Base or leg options.
  - Floating spacer option has a finished top.
  - Solid spacer option has an unfinished top.
- Shelves are 0.75”(19mm) thick and adjust 1.26”(32mm) up or down only.
  - 1H: open interior storage.
  - 2H: one adjustable shelf.
  - 3H: two adjustable shelves.
- Interior height dimension is based upon leg/base option chosen; refer to Specification Guide.
- Base/Leg Options:
  - Plinth Base with plastic edge (L); requires edge trim color.
  - Chamfer leg (P); requires trim color.
- Glide adjustment range:
  - Side Panel Base: 1”(25mm).
  - Plinth Base/Chamfer Leg: 1.25”(32mm).
- Spacer Options:
  - Floating Spacer (F); requires trim color (finished top).
  - Solid Spacer with plastic edge (L); requires edge trim color (unfinished top).
  - No Spacer (U); no surface specification required (unfinished top).
  - No Spacer (N); no surface specification required (finished top).
- Floating and solid spacers are 1.19”(30mm) high.
- Case ships assembled; Spacers and Plinth Base/Legs require field installation.

## Specification Tips

- Finished Back is separately specified when storage unit back is exposed.
- 2H storage unit requires a solid or floating spacer for a 29”(737mm) high Adaptable worksurface.
- For panel mounted applications; separately specify appropriate attachment brackets for support and load purposes.
- Storage Unit without Doors:
  - with solid spacer is not intended for use with a knife edge Adaptable worksurface due to dimensional differences.
  - without spacer with finished or unfinished top may be used in a slip-fit or nested Adaptable worksurface application.
  - without spacer is for use with edgeband Adaptable worksurface only; not intended for use with knife edge due to dimensional differences.
- Counterweight is not needed in a storage unit.
- Side panel base option provides approximately 1.625”(41mm) additional interior storage capacity. Refer to Specification Guide for details.
- Stack-on Storage:
  - may be used with 1H or 2H storage unit; storage unit and stack-on to be same width.
  - may not be used with 3H storage unit.
- Refer to Specification Guide for planning information.

## To Order, Specify:

- Product number, including:

### 1 Base/Leg Options:

- E** Side Panel Base
- L** Plinth Base/Plastic Edge, add **\$448.21** list.
- P** Chamfer Leg, add **\$146.32** list.

### 2 Spacer Options:

- F** Floating Spacer/finished top 18”(457mm) deep, add **\$206.27** list. 24”(610mm) deep, add **\$227.79** list.
- L** Solid Spacer/Plastic Edge/unfinished top, add **\$286.96** list.
- U** No Spacer/unfinished top
- N** No Spacer/finished top

- Case laminate surface color.
- Base/Leg trim color. Side Panel Base (E) - (No finish specification.) Plinth Base (L) - Edge trim color. Chamfer (P) - Trim color.
- Spacer trim color. Floating Spacer (F) - Trim color. Solid Spacer (L) - Edge trim color.
- Laminate case edge trim color.

## Storage Unit without Doors

Actual Height No Spacer	Actual Height w/Spacer	Nominal Depth Inset Back*	Actual Width	Number	①	②	Laminate A	B
<b>1H</b>								
14.8"(376mm)	16.0"(406mm)	16"(406mm)	29.88"(759mm)	BZSN-1830-LN1N		N	\$1322.65	\$1428.50
			35.88"(911mm)	BZSN-1836-LN1N		N	1397.11	1502.96
		22"(559mm)	29.88"(759mm)	BZSN-2430-LN1N		N	1392.72	1498.57
			35.88"(911mm)	BZSN-2436-LN1N		N	1467.18	1573.03
<b>2H</b>								
26.9"(683mm)	28.0"(711mm)	16"(406mm)	29.88"(759mm)	BZSN-1830-LN2N		N	\$1904.37	\$2010.22
			35.88"(911mm)	BZSN-1836-LN2N		N	1978.83	2084.68
		22"(559mm)	29.88"(759mm)	BZSN-2430-LN2N		N	1974.44	2080.29
			35.88"(911mm)	BZSN-2436-LN2N		N	2048.90	2154.75
<b>3H</b>								
38.9"(988mm)	40.1"(1019mm)	16"(406mm)	29.88"(759mm)	BZSN-1830-LN3N		N	\$2420.27	\$2526.12
			35.88"(911mm)	BZSN-1836-LN3N		N	2494.73	2600.58
		22"(559mm)	29.88"(759mm)	BZSN-2430-LN3N		N	2490.34	2596.19
			35.88"(911mm)	BZSN-2436-LN3N		N	2564.80	2670.65

\*Unfinished Inset Back

This page intentionally blank



# Personal Storage Tower with Side Bookcase

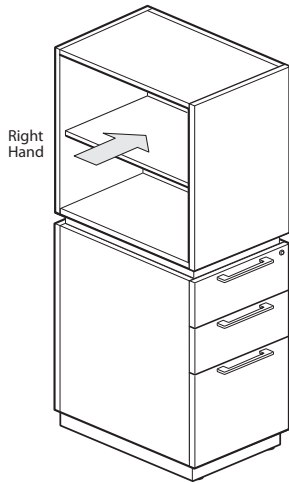

BZRH-LLR

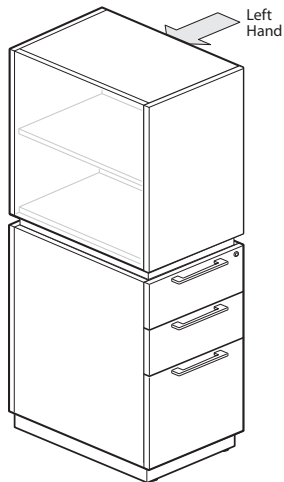

BZRH-LLL

## Features

- Freestanding Personal Storage Tower with Side Bookcase includes:
  - Base or leg and drawer pull options.
  - Bookcase with side access.
  - Black miterfold drawer interiors.
  - Bookcase interior/shelves are same finish specified on case.
  - Laminate case with back with inset top, drawer fronts and bookcase interior.
- Bookcase includes:
  - 49”(1245mm)/57”(1448mm) high: one adjustable shelf.
  - 65”(1651mm)/73”(1854mm) high: two adjustable shelves.
  - Shelf adjustment: 1.26”(32mm) up or down only
- Box drawers include one black plastic divider each.
- One black plastic pencil tray included.
- File drawer includes integrated file hanging system and two file hangar bars per drawer for letter front-to-back filing.
- All drawers have full extension slides.
- Standard with single lock; lock plug available in chrome or black.
- For lock options refer to Lock Program section of the Accessories Price List.
- Drawer Pull Options:
  - Crescent (7), Linear (8) and Classic (9) pulls standard in Brushed Nickel finish (no specification required).
  - Patterns (6) pull standard in Anodized Aluminum finish (no specification required).
  - Integrated Aluminum J-Pull (K); aluminum finger pull requires trim color.
- Base/Leg Options:
  - Side Panel Base (E); sides/front extend to floor; side panels are part of case.
  - Plinth Base with plastic edge (L); requires edge trim color.
  - Chamfer leg (P); requires trim color.
- Glide height adjustment ranges:
  - Chamfer leg: 1.25”(32mm).
  - Side Panel Base/Plinth Base: 2”(51mm).
- Side bookcase orientation:
  - (R) right-hand side of unit
  - (L) left-hand side of unit
- Spacer Options:
  - Solid Spacer with plastic edge (L); requires edge trim color.
- Solid Spacers are 1.19”(30mm) high.
- Case ships assembled; Base/Legs require field installation.

## To Order, Specify:

1) Product number, including:

### 1 Pull Options:

- 6** Patterns
- 7** Crescent
- 8** Linear
- 9** Classic
- K** Aluminum J-Pull

### 2 Base/Leg Options:

- E** Side Panel Base
- L** Plinth Base/Plastic Edge, add **\$265.27** list.
- P** Chamfer Leg, add **\$146.32** list.

### 3 Bookcase Orientation:

- R** Right hand bookcase
- L** Left hand bookcase

2) Case laminate surface color.

3) Base/Leg trim color.  
Side Panel Base (E) - (No finish specification.)  
Plinth Base (L) - Edge trim color.  
Chamfer (P) - Trim color.

4) Spacer trim color.

5) Lock plug trim color.

6) Aluminum J-Pull trim color, if applicable.

7) Laminate case edge trim color.

## Specification Tips

- Counterweight is not needed in a personal storage tower.
- Personal Storage Tower heights compliment Compose panel heights.
- Personal Storage Tower with Side Bookcase does not accommodate additional shelves.
- Refer to Specification Guide for planning information.

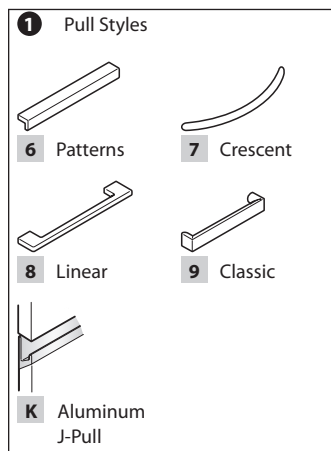

# Personal Storage Tower with Side Bookcase

Actual Height	Actual Depth	Actual Width	Description	Pull	Number	①	②	③	Laminate A	B
49"(1245mm)	17.68"(449mm)	15.5"(394mm)	Box/Box/File	7,8,9	BZRH-4918-LLB	■	■	LL	\$3161.16	\$3413.63
				K	BZRH-4918-LLBK	■	■	LL	3510.90	3763.37
				6	BZRH-4918-LLB6	■	■	LL	3457.08	3709.55
57"(1448mm)	17.68"(449mm)	15.5"(394mm)	Box/Box/File	7,8,9	BZRH-5718-LLB	■	■	LL	\$3261.77	\$3522.29
				K	BZRH-5718-LLBK	■	■	LL	3611.51	3872.03
				6	BZRH-5718-LLB6	■	■	LL	3557.69	3818.21
65"(1651mm)	17.68"(449mm)	15.5"(394mm)	Box/Box/File	7,8,9	BZRH-6518-LLB	■	■	LL	\$3362.38	\$3630.95
				K	BZRH-6518-LLBK	■	■	LL	3712.12	3980.69
				6	BZRH-6518-LLB6	■	■	LL	3658.30	3926.87
73"(1854mm)	17.68"(449mm)	15.5"(394mm)	Box/Box/File	7,8,9	BZRH-7318-LLB	■	■	LL	\$3462.99	\$3739.61
				K	BZRH-7318-LLBK	■	■	LL	3812.73	4089.35
				6	BZRH-7318-LLB6	■	■	LL	3758.91	4035.53
49"(1245mm)	17.68"(449mm)	15.5"(394mm)	File/File	7,8,9	BZRJ-4918-LLB	■	■	LL	\$3161.16	\$3413.63
				K	BZRJ-4918-LLBK	■	■	LL	3510.90	3763.37
				6	BZRJ-4918-LLB6	■	■	LL	3457.08	3709.55
57"(1448mm)	17.68"(449mm)	15.5"(394mm)	File/File	7,8,9	BZRJ-5718-LLB	■	■	LL	\$3261.77	\$3522.29
				K	BZRJ-5718-LLBK	■	■	LL	3611.51	3872.03
				6	BZRJ-5718-LLB6	■	■	LL	3557.69	3818.21
65"(1651mm)	17.68"(449mm)	15.5"(394mm)	File/File	7,8,9	BZRJ-6518-LLB	■	■	LL	\$3362.38	\$3630.95
				K	BZRJ-6518-LLBK	■	■	LL	3712.12	3980.69
				6	BZRJ-6518-LLB6	■	■	LL	3658.30	3926.87
73"(1854mm)	17.68"(449mm)	15.5"(394mm)	File/File	7,8,9	BZRJ-7318-LLB	■	■	LL	\$3462.99	\$3739.61
				K	BZRJ-7318-LLBK	■	■	LL	3812.73	4089.35
				6	BZRJ-7318-LLB6	■	■	LL	3758.91	4035.53
49"(1245mm)	23.68"(601mm)	15.5"(394mm)	Box/Box/File	7,8,9	BZRH-4924-LLB	■	■	LL	\$3228.85	\$3486.71
				K	BZRH-4924-LLBK	■	■	LL	3578.59	3836.45
				6	BZRH-4924-LLB6	■	■	LL	3524.77	3782.63
57"(1448mm)	23.68"(601mm)	15.5"(394mm)	Box/Box/File	7,8,9	BZRH-5724-LLB	■	■	LL	\$3329.46	\$3595.37
				K	BZRH-5724-LLBK	■	■	LL	3679.20	3945.11
				6	BZRH-5724-LLB6	■	■	LL	3625.38	3891.29
65"(1651mm)	23.68"(601mm)	15.5"(394mm)	Box/Box/File	7,8,9	BZRH-6524-LLB	■	■	LL	\$3430.07	\$3704.03
				K	BZRH-6524-LLBK	■	■	LL	3779.81	4053.77
				6	BZRH-6524-LLB6	■	■	LL	3725.99	3999.95
73"(1854mm)	23.68"(601mm)	15.5"(394mm)	Box/Box/File	7,8,9	BZRH-7324-LLB	■	■	LL	\$3530.68	\$3812.69
				K	BZRH-7324-LLBK	■	■	LL	3880.42	4162.43
				6	BZRH-7324-LLB6	■	■	LL	3826.60	4108.61
49"(1245mm)	23.68"(601mm)	15.5"(394mm)	File/File	7,8,9	BZRJ-4924-LLB	■	■	LL	\$3228.85	\$3486.71
				K	BZRJ-4924-LLBK	■	■	LL	3578.59	3836.45
				6	BZRJ-4924-LLB6	■	■	LL	3524.77	3782.63
57"(1448mm)	23.68"(601mm)	15.5"(394mm)	File/File	7,8,9	BZRJ-5724-LLB	■	■	LL	\$3329.46	\$3595.37
				K	BZRJ-5724-LLBK	■	■	LL	3679.20	3945.11
				6	BZRJ-5724-LLB6	■	■	LL	3625.38	3891.29
65"(1651mm)	23.68"(601mm)	15.5"(394mm)	File/File	7,8,9	BZRJ-6524-LLB	■	■	LL	\$3430.07	\$3704.03
				K	BZRJ-6524-LLBK	■	■	LL	3779.81	4053.77
				6	BZRJ-6524-LLB6	■	■	LL	3725.99	3999.95
73"(1854mm)	23.68"(601mm)	15.5"(394mm)	File/File	7,8,9	BZRJ-7324-LLB	■	■	LL	\$3530.68	\$3812.69
				K	BZRJ-7324-LLBK	■	■	LL	3880.42	4162.43
				6	BZRJ-7324-LLB6	■	■	LL	3826.60	4108.61
49"(1245mm)	29.68"(754mm)	15.5"(394mm)	Box/Box/File	7,8,9	BZRH-4930-LLB	■	■	LL	\$3296.54	\$3559.79
				K	BZRH-4930-LLBK	■	■	LL	3646.28	3909.53
				6	BZRH-4930-LLB6	■	■	LL	3592.46	3855.71
57"(1448mm)	29.68"(754mm)	15.5"(394mm)	Box/Box/File	7,8,9	BZRH-5730-LLB	■	■	LL	\$3397.15	\$3668.45
				K	BZRH-5730-LLBK	■	■	LL	3746.89	4018.19
				6	BZRH-5730-LLB6	■	■	LL	3693.07	3964.37
65"(1651mm)	29.68"(754mm)	15.5"(394mm)	Box/Box/File	7,8,9	BZRH-6530-LLB	■	■	LL	\$3497.76	\$3777.11
				K	BZRH-6530-LLBK	■	■	LL	3847.50	4126.85
				6	BZRH-6530-LLB6	■	■	LL	3793.68	4073.03
73"(1854mm)	29.68"(754mm)	15.5"(394mm)	Box/Box/File	7,8,9	BZRH-7330-LLB	■	■	LL	\$3598.37	\$3885.77
				K	BZRH-7330-LLBK	■	■	LL	3948.11	4235.51
				6	BZRH-7330-LLB6	■	■	LL	3894.29	4181.69

## Personal Storage Tower with Side Bookcase

Actual Height	Actual Depth	Actual Width	Description	Pull	Number	① ② ③	Laminate A	B
49"(1245mm)	29.68"(754mm)	15.5"(394mm)	File/File	7,8,9	BZRJ-4930-LLB	LL	\$3296.54	\$3559.79
				K	BZRJ-4930-LLBK	LL	3646.28	3909.53
				6	BZRJ-4930-LLB6	LL	3592.46	3855.71
57"(1448mm)	29.68"(754mm)	15.5"(394mm)	File/File	7,8,9	BZRJ-5730-LLB	LL	\$3397.15	\$3668.45
				K	BZRJ-5730-LLBK	LL	3746.89	4018.19
				6	BZRJ-5730-LLB6	LL	3693.07	3964.37
65"(1651mm)	29.68"(754mm)	15.5"(394mm)	File/File	7,8,9	BZRJ-6530-LLB	LL	\$3497.76	\$3777.11
				K	BZRJ-6530-LLBK	LL	3847.50	4126.85
				6	BZRJ-6530-LLB6	LL	3793.68	4073.03
73"(1854mm)	29.68"(754mm)	15.5"(394mm)	File/File	7,8,9	BZRJ-7330-LLB	LL	\$3598.37	\$3885.77
				K	BZRJ-7330-LLBK	LL	3948.11	4235.51
				6	BZRJ-7330-LLB6	LL	3894.29	4181.69

This page intentionally blank

# Personal Storage Tower with Wardrobe

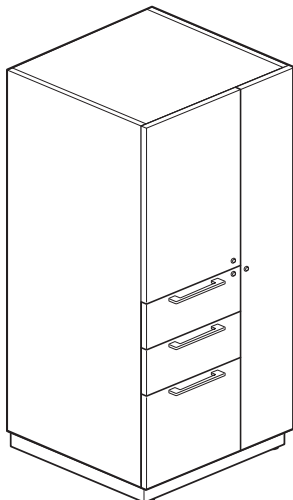

BZVH-LR

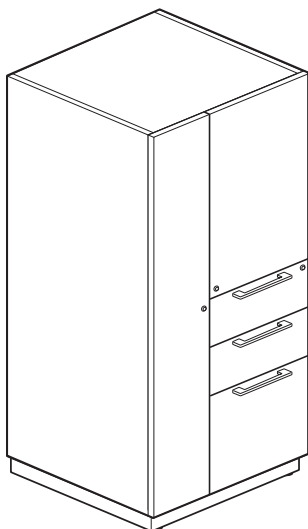

BZVH-LL

**Note:** Graphics shown with plinth base.

### Features

- Freestanding Personal Storage Tower with Wardrobe includes:
  - Laminate case standard with unfinished inset back, inset top, drawer fronts and touch-latch doors.
  - Base or leg and drawer pull options.
  - Wardrobe and upper storage units with touch-latch doors.
  - Black miterfold drawer interiors.
  - Wardrobe/upper storage interiors/shelves are same finish specified on case.
- Storage unit includes:
  - 49"(1245mm)/57"(1448mm) high: one adjustable shelf.
  - 65"(1651mm)/73"(1854mm) high: two adjustable shelves.
  - Shelf adjustment: 1.26"(32mm) up or down only.
- Wardrobe includes:
  - 18"(457mm) deep: stainless steel coat hook and one fixed shelf.
  - 24"(610mm)/30"(762mm) deep: chrome coat rod and one fixed shelf.
- File drawer includes integrated file hanging system and two file hangar bars per drawer for letter front-to-back filing.
- All drawers have full extension slides.
- Drawer Pull Options:
  - Crescent (7), Linear (8) and Classic (9) pulls standard in Brushed Nickel finish (no specification required).
  - Patterns (6) pull standard in Anodized Aluminum finish (no specification required).
  - Integrated Aluminum J-Pull (K); aluminum finger pull requires trim color.
- Base/Leg Options:
  - Side Panel Base (E); sides/front extend to floor; side panels are part of case.
  - Plinth Base with plastic edge (L); requires edge trim color.
  - Chamfer leg (P); requires trim color.
- Glide adjustment range:
  - Side Panel Base: 1"(25mm).
  - Plinth Base/Chamfer Leg: 1.25"(32mm).
- Locking Option:
  - Drawers standard with single lock.
  - Lock plugs available in chrome or black.
  - For Lock options refer to Lock Program section of the Accessories Price List.
- Wardrobe orientation:
  - (R) right-hand side of unit
  - (L) left-hand side of unit
- Case ships assembled; Base/Legs require field installation.

### To Order, Specify:

1) Product number, including:

#### 1 Pull Options:

- 6** Patterns
- 7** Crescent
- 8** Linear
- 9** Classic
- K** Aluminum J-Pull

#### 2 Base/Leg Options:

- E** Side Panel Base
- L** Plinth Base/Plastic Edge, add **\$331.79** list.
- P** Chamfer Leg, add **\$146.32** list.

#### 3 Lock Options:

- L** Locking, add **\$391.48** list.
- N** Non-locking

#### 4 Wardrobe Orientation:

- R** Right hand wardrobe
- L** Left hand wardrobe

- Case laminate surface color.
- Base/Leg trim color.
  - Side Panel Base (E) - (No finish specification.)
  - Plinth Base (L) - Edge trim color.
  - Chamfer (P) - Trim color.
- Lock plug trim color.
- Aluminum J-Pull trim color.
- Laminate case edge trim color.

### Specification Tips

- Finished back is separately specified when personal storage tower with wardrobe back is exposed.
- Counterweight is not needed in a personal storage tower.
- Side panel base option provides approximately 1.625"(41mm) additional interior storage capacity on wardrobe side. Refer to Specification Guide for details.
- Personal Storage Tower with Wardrobe does not accommodate additional shelves.
- Refer to Specification Guide for planning information.

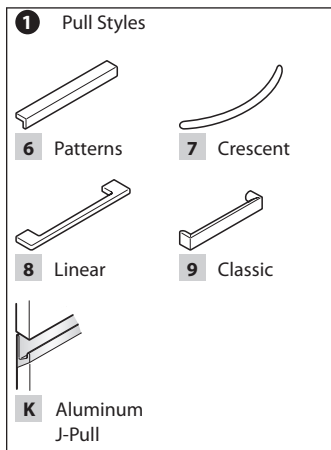

# Personal Storage Tower with Wardrobe

Actual Height	Actual Depth	Actual Width	Description	Pull	Number	① ② ③ ④				Laminate	
						A	B				
49"(1245mm)	16.9"(429mm)	23.88"(607mm)	Box/Box/File	7,8,9	BZVH-4918-LLB	■	■	■	N	\$3766.70	\$4052.09
				K	BZVH-4918-LLBK	■	■	N	\$4116.44	\$4401.83	
				6	BZVH-4918-LLB6	■	■	N	\$4062.62	\$4348.01	
57"(1448mm)	16.9"(429mm)	23.88"(607mm)	Box/Box/File	7,8,9	BZVH-5718-LLB	■	■	■	N	\$3903.17	\$4199.51
				K	BZVH-5718-LLBK	■	■	N	\$4252.91	\$4549.25	
				6	BZVH-5718-LLB6	■	■	N	\$4199.09	\$4495.43	
65"(1651mm)	16.9"(429mm)	23.88"(607mm)	Box/Box/File	7,8,9	BZVH-6518-LLB	■	■	■	N	\$4039.64	\$4346.93
				K	BZVH-6518-LLBK	■	■	N	\$4389.38	\$4696.67	
				6	BZVH-6518-LLB6	■	■	N	\$4335.56	\$4642.85	
73"(1854mm)	16.9"(429mm)	23.88"(607mm)	Box/Box/File	7,8,9	BZVH-7318-LLB	■	■	■	N	\$4176.11	\$4494.35
				K	BZVH-7318-LLBK	■	■	N	\$4525.85	\$4844.09	
				6	BZVH-7318-LLB6	■	■	N	\$4472.03	\$4790.27	
49"(1245mm)	16.9"(429mm)	23.88"(607mm)	File/File	7,8,9	BZVJ-4918-LLB	■	■	■	N	\$3680.70	\$3958.77
				K	BZVJ-4918-LLBK	■	■	N	\$4030.44	\$4308.51	
				6	BZVJ-4918-LLB6	■	■	N	\$3976.62	\$4254.69	
57"(1448mm)	16.9"(429mm)	23.88"(607mm)	File/File	7,8,9	BZVJ-5718-LLB	■	■	■	N	\$3817.17	\$4106.19
				K	BZVJ-5718-LLBK	■	■	N	\$4166.91	\$4455.93	
				6	BZVJ-5718-LLB6	■	■	N	\$4113.09	\$4402.11	
65"(1651mm)	16.9"(429mm)	23.88"(607mm)	File/File	7,8,9	BZVJ-6518-LLB	■	■	■	N	\$3953.64	\$4253.61
				K	BZVJ-6518-LLBK	■	■	N	\$4303.38	\$4603.35	
				6	BZVJ-6518-LLB6	■	■	N	\$4249.56	\$4549.53	
73"(1854mm)	16.9"(429mm)	23.88"(607mm)	File/File	7,8,9	BZVJ-7318-LLB	■	■	■	N	\$4090.11	\$4401.03
				K	BZVJ-7318-LLBK	■	■	N	\$4439.85	\$4750.77	
				6	BZVJ-7318-LLB6	■	■	N	\$4386.03	\$4696.95	
49"(1245mm)	22.9"(582mm)	23.88"(607mm)	Box/Box/File	7,8,9	BZVH-4924-LLB	■	■	■	N	\$3844.79	\$4136.40
				K	BZVH-4924-LLBK	■	■	N	\$4194.53	\$4486.14	
				6	BZVH-4924-LLB6	■	■	N	\$4140.71	\$4432.32	
57"(1448mm)	22.9"(582mm)	23.88"(607mm)	Box/Box/File	7,8,9	BZVH-5724-LLB	■	■	■	N	\$3981.26	\$4283.82
				K	BZVH-5724-LLBK	■	■	N	\$4331.00	\$4633.56	
				6	BZVH-5724-LLB6	■	■	N	\$4277.18	\$4579.74	
65"(1651mm)	22.9"(582mm)	23.88"(607mm)	Box/Box/File	7,8,9	BZVH-6524-LLB	■	■	■	N	\$4117.73	\$4431.24
				K	BZVH-6524-LLBK	■	■	N	\$4467.47	\$4780.98	
				6	BZVH-6524-LLB6	■	■	N	\$4413.65	\$4727.16	
73"(1854mm)	22.9"(582mm)	23.88"(607mm)	Box/Box/File	7,8,9	BZVH-7324-LLB	■	■	■	N	\$4254.20	\$4578.66
				K	BZVH-7324-LLBK	■	■	N	\$4603.94	\$4928.40	
				6	BZVH-7324-LLB6	■	■	N	\$4550.12	\$4874.58	
49"(1245mm)	22.9"(582mm)	23.88"(607mm)	File/File	7,8,9	BZVJ-4924-LLB	■	■	■	N	\$3758.79	\$4043.08
				K	BZVJ-4924-LLBK	■	■	N	\$4108.53	\$4392.82	
				6	BZVJ-4924-LLB6	■	■	N	\$4054.71	\$4339.00	
57"(1448mm)	22.9"(582mm)	23.88"(607mm)	File/File	7,8,9	BZVJ-5724-LLB	■	■	■	N	\$3895.26	\$4190.50
				K	BZVJ-5724-LLBK	■	■	N	\$4245.00	\$4540.24	
				6	BZVJ-5724-LLB6	■	■	N	\$4191.18	\$4486.42	
65"(1651mm)	22.9"(582mm)	23.88"(607mm)	File/File	7,8,9	BZVJ-6524-LLB	■	■	■	N	\$4031.73	\$4337.92
				K	BZVJ-6524-LLBK	■	■	N	\$4381.47	\$4687.66	
				6	BZVJ-6524-LLB6	■	■	N	\$4327.65	\$4633.84	
73"(1854mm)	22.9"(582mm)	23.88"(607mm)	File/File	7,8,9	BZVJ-7324-LLB	■	■	■	N	\$4168.20	\$4485.34
				K	BZVJ-7324-LLBK	■	■	N	\$4517.94	\$4835.08	
				6	BZVJ-7324-LLB6	■	■	N	\$4464.12	\$4781.26	

## Personal Storage Tower with Wardrobe

Actual Height	Actual Depth	Actual Width	Description	Pull	Number	①	②	③	④	Laminate A	B
49"(1245mm)	28.9"(734mm)	23.88"(607mm)	Box/Box/File	7,8,9	BZVH-4930-LLB	■	■	■	N	\$3922.88	\$4220.71
				K	BZVH-4930-LLBK	■	■	■	N	4272.62	4570.45
				6	BZVH-4930-LLB6	■	■	■	N	4218.80	4516.63
57"(1448mm)	28.9"(734mm)	23.88"(607mm)	Box/Box/File	7,8,9	BZVH-5730-LLB	■	■	■	N	\$4059.35	\$4368.13
				K	BZVH-5730-LLBK	■	■	■	N	4409.09	4717.87
				6	BZVH-5730-LLB6	■	■	■	N	4355.27	4664.05
65"(1651mm)	28.9"(734mm)	23.88"(607mm)	Box/Box/File	7,8,9	BZVH-6530-LLB	■	■	■	N	\$4195.82	\$4515.55
				K	BZVH-6530-LLBK	■	■	■	N	4545.56	4865.29
				6	BZVH-6530-LLB6	■	■	■	N	4491.74	4811.47
73"(1854mm)	28.9"(734mm)	23.88"(607mm)	Box/Box/File	7,8,9	BZVH-7330-LLB	■	■	■	N	\$4332.29	\$4662.97
				K	BZVH-7330-LLBK	■	■	■	N	4682.03	5012.71
				6	BZVH-7330-LLB6	■	■	■	N	4628.21	4958.89
49"(1245mm)	28.9"(734mm)	23.88"(607mm)	File/File	7,8,9	BZVJ-4930-LLB	■	■	■	N	\$3836.88	\$4127.39
				K	BZVJ-4930-LLBK	■	■	■	N	4186.62	4477.13
				6	BZVJ-4930-LLB6	■	■	■	N	4132.80	4423.31
57"(1448mm)	28.9"(734mm)	23.88"(607mm)	File/File	7,8,9	BZVJ-5730-LLB	■	■	■	N	\$3973.35	\$4274.81
				K	BZVJ-5730-LLBK	■	■	■	N	4323.09	4624.55
				6	BZVJ-5730-LLB6	■	■	■	N	4269.27	4570.73
65"(1651mm)	28.9"(734mm)	23.88"(607mm)	File/File	7,8,9	BZVJ-6530-LLB	■	■	■	N	\$4109.82	\$4422.23
				K	BZVJ-6530-LLBK	■	■	■	N	4459.56	4771.97
				6	BZVJ-6530-LLB6	■	■	■	N	4405.74	4718.15
73"(1854mm)	28.9"(734mm)	23.88"(607mm)	File/File	7,8,9	BZVJ-7330-LLB	■	■	■	N	\$4246.29	\$4569.65
				K	BZVJ-7330-LLBK	■	■	■	N	4596.03	4919.39
				6	BZVJ-7330-LLB6	■	■	■	N	4542.21	4865.57

# Wardrobes

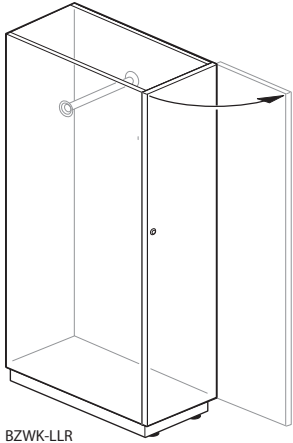

BZWK-LLR

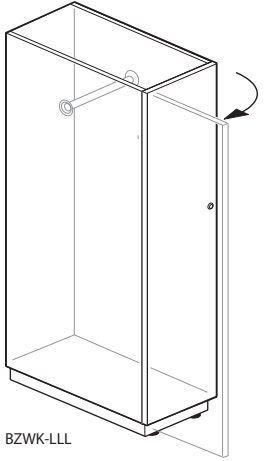

BZWK-LLL

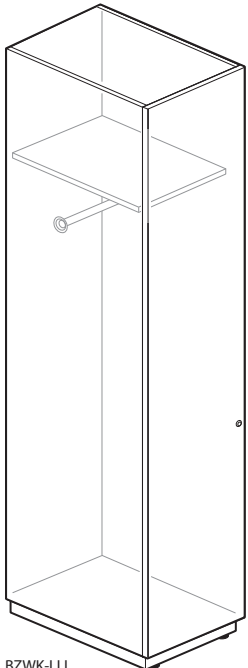

BZWK-LLL

**Note:** Graphics shown with plinth base.

## Features

- Wardrobe includes:
  - Laminate case standard with unfinished inset back, inset top and touch-latch door.
  - Base or leg options.
  - 18”(457mm) depths include coat hook.
  - 24”(610mm)/30”(762mm) depths include coat rod.
- 73”(1854mm) high includes coat rod and one fixed shelf.
- Wardrobe interiors/shelves are same finish specified on case.
- Base/Leg Options:
  - Side Panel Base (E); sides/front extend to floor; side panels are part of case.
  - Plinth Base with plastic edge (L); requires edge trim color.
  - Chamfer leg (P); requires trim color.
- Glide adjustment range:
  - Side Panel Base: 1”(25mm).
  - Plinth Base/Chamfer Leg: 1.25”(32mm).
- Locking Option:
  - Lock plug available in chrome or black.
  - For lock options, refer to Lock Program section of the Accessories Price List.
- Door Swing Orientation:
  - (R) right-hand
  - (L) left-hand
- Case ships assembled; Base/Legs require field installation.

## Specification Tips

- Finished back is separately specified when wardrobe back is exposed.
- Counterweight is not needed in a wardrobe.
- 12”(305mm) wide wardrobes must be attached to panel or adjacent worksurface or another storage unit.
- Side panel base option provides approximately 1.625”(41mm) additional interior storage capacity. Refer to Specification Guide for details.
- Wardrobe door swing orientation is not field changeable.
- Refer to Specification Guide for planning information.

## To Order, Specify:

1) Product number, including:

### 1 Base/Leg Options:

- E** Side Panel Base
- L** Plinth Base/Plastic Edge, add **\$331.79** list.
- P** Chamfer Leg, add **\$146.32** list.

### 2 Lock Options:

- L** Locking, add **\$195.74** list.
- N** Non-locking

### 3 Door Swing Orientation:

- R** Right hand swing
- L** Left hand swing

2) Case laminate surface color.

3) Base/Leg trim color.  
Side Panel Base (E) - (No finish specification.)  
Plinth Base (L) - Edge trim color.  
Chamfer (P) - Trim color.

4) Lock plug trim color, if applicable.

5) Laminate case edge trim color.



# Wardrobes

Actual Height	Actual Depth	Actual Width	Number	①	②	③	Laminate A	B
49"(1245mm)	16.9"(429mm)	11.88"(302mm)	BZWK-4918-LLNT	■	■	N	\$1997.68	\$2156.83
57"(1448mm)			BZWK-5718-LLNT	■	■	N	2134.15	2304.25
65"(1651mm)			BZWK-6518-LLNT	■	■	N	2270.62	2451.67
73"(1854mm)			BZWK-7318-LLNT	■	■	N	2407.09	2599.09
49"(1245mm)	22.9"(582mm)	11.88"(302mm)	BZWK-4924-LLNT	■	■	N	\$2075.77	\$2241.14
57"(1448mm)			BZWK-5724-LLNT	■	■	N	2212.24	2388.56
65"(1651mm)			BZWK-6524-LLNT	■	■	N	2348.71	2535.98
73"(1854mm)			BZWK-7324-LLNT	■	■	N	2485.18	2683.40
49"(1245mm)	28.9"(734mm)	11.88"(302mm)	BZWK-4930-LLNT	■	■	N	\$2153.86	\$2325.45
57"(1448mm)			BZWK-5730-LLNT	■	■	N	2290.33	2472.87
65"(1651mm)			BZWK-6530-LLNT	■	■	N	2426.80	2620.29
73"(1854mm)			BZWK-7330-LLNT	■	■	N	2563.27	2767.71
49"(1245mm)	16.9"(429mm)	17.88"(454mm)	BZWF-4918-LLNT	■	■	N	\$2240.98	\$2420.25
57"(1448mm)			BZWF-5718-LLNT	■	■	N	2377.45	2567.67
65"(1651mm)			BZWF-6518-LLNT	■	■	N	2513.92	2715.09
73"(1854mm)			BZWF-7318-LLNT	■	■	N	2650.39	2862.51
49"(1245mm)	22.9"(582mm)	17.88"(454mm)	BZWF-4924-LLNT	■	■	N	\$2319.07	\$2504.56
57"(1448mm)			BZWF-5724-LLNT	■	■	N	2455.54	2651.98
65"(1651mm)			BZWF-6524-LLNT	■	■	N	2592.01	2799.40
73"(1854mm)			BZWF-7324-LLNT	■	■	N	2728.48	2946.82
49"(1245mm)	28.9"(734mm)	17.88"(454mm)	BZWF-4930-LLNT	■	■	N	\$2397.16	\$2588.87
57"(1448mm)			BZWF-5730-LLNT	■	■	N	2533.63	2736.29
65"(1651mm)			BZWF-6530-LLNT	■	■	N	2670.10	2883.71
73"(1854mm)			BZWF-7330-LLNT	■	■	N	2806.57	3031.13

# Stack-on Storage

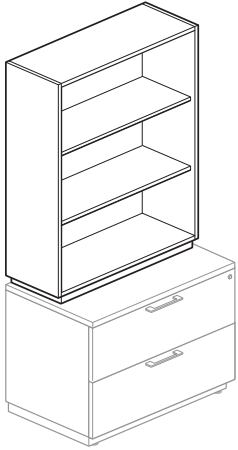

BZDL-LNNSNN

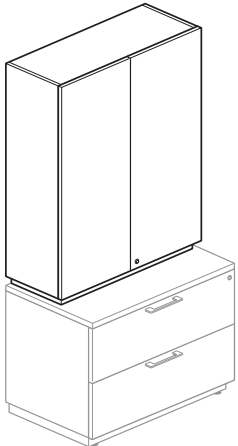

BZKL-LLFTSLN

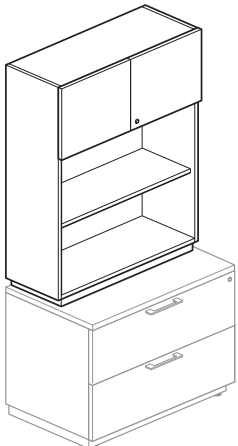

BZKL-LLPTSLN

### Features

- Stack-on Storage includes:
  - Laminate case standard with unfinished inset back, inset top with shelf/shelves.
  - Base reveal/interiors/shelves are same finish specified on case.
  - Available with full touch-latch doors, partial touch-latch doors or no doors.
- Shelves adjust in increments of 1.26”(32mm) up or down only.
- Door height options:
  - Full height: Full height doors.
  - Partial Height: Doors on top only.
  - No Doors: Open unit.
- Locking Option:
  - Touch-latch doors available with or without locks.
  - Lock plugs available in chrome or black.
  - For lock options, refer to Lock Program section of the Accessories Price List.
- Case shipped assembled.

### Specification Tips

- Finished back is separately specified when stack-on storage back is exposed.
- For use with 1H or 2H storage unit with spacer and an Adaptable Worksurface or a Compose storage top.
- Lower storage unit does not require a counterweight when used with a Stack-on.
- A Stack-on unit attached to a lower storage unit with spacer and Adaptable Worksurface or Compose storage top will compliment Compose panel heights.
- A Stack-on unit attached to a lower storage unit without spacer with a Compose storage top may be positioned in a freestanding application; height will not align with Compose panel heights.
- Not recommended for use directly on top of a storage unit without spacer.
- Width of Stack-on unit and lower storage unit must be the same.

### To Order, Specify:

- Product number, including:

#### ① Locking Option (Doors)

**L** Locking, add \$195.74 list.

**N** None

- Case laminate surface color.
- Lock plug trim color, if applicable.
- Laminate case edge trim color.

## Stack-on Storage

Actual Height	Actual Depth	Actual Width	Number	Laminate A	B
<b>Without Doors</b>					
19"(483mm)	13.3"(338mm)	29.88"(759mm)	BZDL-1930-LNNSNN	\$1428.71	\$1531.16
		35.88"(911mm)	BZDL-1936-LNNSNN	1450.66	1553.11
27"(686mm)		29.88"(759mm)	BZDL-2730-LNNSNN	\$1637.25	\$1739.70
		35.88"(911mm)	BZDL-2736-LNNSNN	1659.20	1761.65
31"(787mm)		29.88"(759mm)	BZDL-3130-LNNSNN	\$1741.52	\$1843.97
		35.88"(911mm)	BZDL-3136-LNNSNN	1763.47	1865.92
35"(889mm)		29.88"(759mm)	BZDL-3530-LNNSNN	\$1845.79	\$1948.24
		35.88"(911mm)	BZDL-3536-LNNSNN	1867.74	1970.19
39"(991mm)		29.88"(759mm)	BZDL-3930-LNNSNN	\$1950.06	\$2052.51
		35.88"(911mm)	BZDL-3936-LNNSNN	1972.01	2074.46
43"(1092mm)		29.88"(759mm)	BZDL-4330-LNNSNN	\$2054.33	\$2156.78
		35.88"(911mm)	BZDL-4336-LNNSNN	2076.28	2178.73
47"(1194mm)		29.88"(759mm)	BZDL-4730-LNNSNN	\$2158.60	\$2261.05
		35.88"(911mm)	BZDL-4736-LNNSNN	2180.55	2283.00
55"(1397mm)		29.88"(759mm)	BZDL-5530-LNNSNN	\$2367.14	\$2469.59
		35.88"(911mm)	BZDL-5536-LNNSNN	2389.09	2491.54

Actual Height	Actual Depth	Actual Width	Number	Laminate A	B
<b>Full Height Doors</b>					
19"(483mm)	14.3"(363mm)	29.88"(759mm)	BZKL-1930-LLFTS N	\$1942.74	\$2045.19
		35.88"(911mm)	BZKL-1936-LLFTS N	1999.46	2101.91
27"(686mm)		29.88"(759mm)	BZKL-2730-LLFTS N	\$2246.42	\$2348.87
		35.88"(911mm)	BZKL-2736-LLFTS N	2303.14	2405.59
31"(787mm)		29.88"(759mm)	BZKL-3130-LLFTS N	\$2398.26	\$2500.71
		35.88"(911mm)	BZKL-3136-LLFTS N	2454.98	2557.43
35"(889mm)		29.88"(759mm)	BZKL-3530-LLFTS N	\$2550.10	\$2652.55
		35.88"(911mm)	BZKL-3536-LLFTS N	2606.82	2709.27
39"(991mm)		29.88"(759mm)	BZKL-3930-LLFTS N	\$2701.94	\$2804.39
		35.88"(911mm)	BZKL-3936-LLFTS N	2758.66	2861.11
43"(1092mm)		29.88"(759mm)	BZKL-4330-LLFTS N	\$2853.78	\$2956.23
		35.88"(911mm)	BZKL-4336-LLFTS N	2910.50	3012.95
47"(1194mm)		29.88"(759mm)	BZKL-4730-LLFTS N	\$3005.62	\$3108.07
		35.88"(911mm)	BZKL-4736-LLFTS N	3062.34	3164.79
55"(1397mm)		29.88"(759mm)	BZKL-5530-LLFTS N	\$3309.30	\$3411.75
		35.88"(911mm)	BZKL-5536-LLFTS N	3366.02	3468.47
<b>Partial Doors on Top</b>					
35"(889mm)	14.3"(363mm)	29.88"(759mm)	BZKL-3530-LLPTS N	\$2447.71	\$2550.16
		35.88"(911mm)	BZKL-3536-LLPTS N	2495.28	2597.73
43"(1092mm)		29.88"(759mm)	BZKL-4330-LLPTS N	\$2652.61	\$2755.06
		35.88"(911mm)	BZKL-4336-LLPTS N	2700.18	2802.63
47"(1194mm)		29.88"(759mm)	BZKL-4730-LLPTS N	\$2755.06	\$2857.51
		35.88"(911mm)	BZKL-4736-LLPTS N	2802.63	2905.08
55"(1397mm)		29.88"(759mm)	BZKL-5530-LLPTS N	\$2959.96	\$3062.41
		35.88"(911mm)	BZKL-5536-LLPTS N	3007.53	3109.98

# Finished Back

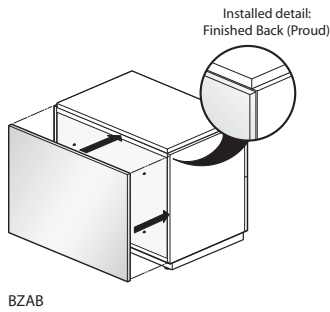

Nominal Height	Nominal Width	Number <sup>①</sup>	Laminate A	B
<b>1H</b>				
14"(356mm)	15.5"(394mm)	BZAB-0116-LS	\$228.78	\$247.12
	30"(762mm)	BZAB-0130-LS	248.05	267.88
	36"(914mm)	BZAB-0136-LS	256.30	276.77
<b>1.5H</b>				
20"(508mm)	15.5"(394mm)	BZAB-0016-LS	\$238.22	\$257.29
	30"(762mm)	BZAB-0030-LS	265.74	286.94
	36"(914mm)	BZAB-0036-LS	277.54	299.65
<b>2H</b>				
26"(660mm)	15.5"(394mm)	BZAB-0216-LS	\$247.65	\$267.45
	30"(762mm)	BZAB-0230-LS	283.43	306.00
	36"(914mm)	BZAB-0236-LS	298.77	322.52
<b>3H</b>				
38"(965mm)	30"(762mm)	BZAB-0330-LS	\$318.82	\$344.12
	36"(914mm)	BZAB-0336-LS	341.24	368.27
<b>Personal Storage Tower with Wardrobe</b>				
49"(1245mm)	24"(610mm)	BZAB-4924-LS	\$322.36	\$347.94
57"(1448mm)		BZAB-5724-LS	341.24	368.27
65"(1651mm)		BZAB-6524-LS	360.11	388.60
73"(1854mm)		BZAB-7324-LS	378.98	408.94
<b>Stack-On Storage</b>				
19"(483mm)	30"(762mm)	BZAB-1930-LS	\$262.79	\$283.76
	36"(914mm)	BZAB-1936-LS	274.00	295.83
27"(686mm)	30"(762mm)	BZAB-2730-LS	\$286.38	\$309.18
	36"(914mm)	BZAB-2736-LS	302.31	326.33
31"(787mm)	30"(762mm)	BZAB-3130-LS	\$298.18	\$321.89
	36"(914mm)	BZAB-3136-LS	316.46	341.58
35"(889mm)	30"(762mm)	BZAB-3530-LS	\$309.98	\$334.59
	36"(914mm)	BZAB-3536-LS	330.62	356.83
39"(991mm)	30"(762mm)	BZAB-3930-LS	\$321.77	\$347.30
	36"(914mm)	BZAB-3936-LS	344.77	372.08
43"(1092mm)	30"(762mm)	BZAB-4330-LS	\$333.57	\$360.01
	36"(914mm)	BZAB-4336-LS	358.93	387.33
47"(1194mm)	30"(762mm)	BZAB-4730-LS	\$345.36	\$372.72
	36"(914mm)	BZAB-4736-LS	373.08	402.58
55"(1397mm)	30"(762mm)	BZAB-5530-LS	\$368.96	\$398.13
	36"(914mm)	BZAB-5536-LS	401.39	433.08
<b>Wardrobes</b>				
49"(1245mm)	12"(305mm)	BZAB-4912-LS	\$264.56	\$285.67
	18"(457mm)	BZAB-4918-LS	293.46	316.80
57"(1448mm)	12"(305mm)	BZAB-5712-LS	\$274.00	\$295.83
	18"(457mm)	BZAB-5718-LS	307.62	332.05
65"(1651mm)	12"(305mm)	BZAB-6512-LS	\$283.43	\$306.00
	18"(457mm)	BZAB-6518-LS	321.77	347.30
73"(1854mm)	12"(305mm)	BZAB-7312-LS	\$292.87	\$316.17
	18"(457mm)	BZAB-7318-LS	335.93	362.55

**Features**

- Includes .75"(19mm) thick finished back and attachment hardware for use with Compose storage units:
  - pedestals, files; lateral or open, combination, storage units, personal storage towers with wardrobe, wardrobes and stack-on storage.
- For use with a single unit in a side-by-side application.
- Field installed.

**Specification Tips**

- Provides a finished back panel in an exposed storage back application.
- Provides a finished back in a storage supported convergent worksurface application.
- Finished Back adds .75"(19mm) to depth of the unfinished inset back storage unit.
- Refer to Specification Guide for planning information.

**To Order, Specify:**

- 1) Product number, including:

**① Unit Base Type:**

- E** Side Panel Base
- M** Legs/Plinth Base

- 2) Laminate surface color.
- 3) Laminate back edge trim color.

# Worksurface Support Panel

**Worksurface Support Panel —  
For use with Panel Mounted  
Adaptable Worksurfaces**

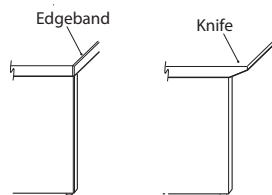
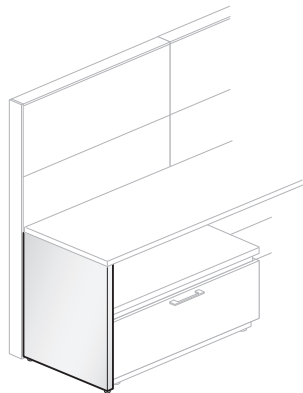

ZZFS

Height	Thickness	Depth	Number ①	Laminate A	B
26.5"(673mm)	1.5"(38mm)	18"(457mm)	ZZFS-1827-LNE	\$481.08	\$509.50
		24"(610mm)	ZZFS-2427-LNE	519.30	549.88
		30"(762mm)	ZZFS-3027-LNE	557.52	590.26
27.5"(699mm)	1.5"(38mm)	18"(457mm)	ZZFS-1800-LNE	\$468.88	\$502.40
		24"(610mm)	ZZFS-2400-LNE	505.12	535.94
		30"(762mm)	ZZFS-3000-LNE	541.36	569.48

**Features**

- Includes worksurface support panel with glides and mounting hardware.
  - Laminate surfaces with plastic edge trim, 3mm radiused user edge provides soft access to knee space.
- Installs in Compose System panel frame component slots and attaches under the end of a worksurface.
- Provides full support for one end of equal depth worksurfaces.
- Recommended in heavy loading conditions.
- Non-handed design may be installed in left-hand, right-hand or shared configuration.
- Adjustable glides provide a maximum of 2.5"(63mm) of height adjustment.

**To Order, Specify:**

- 1) Product number, including:

**① Edge Options:**

- J Edgeband
- F Knife

- 2) Laminate surface color.
- 3) Edge trim color.

**Specification Tips**

- Specify worksurface support panel to match worksurface edge option.
- 26.5"(673mm) high support panel used with 1.19"(30mm) thick worksurface provides 28"(711mm) user height worksurface; intended for a nested application.
- 27.5"(699mm) high support panel used with 1.19"(30mm) thick worksurface provides 29"(737mm) user height worksurface.
- Refer to Specification Guide for planning information.

# Worksurface Support End

	Height	Thickness	Depth	Number <sup>①</sup>	Laminate A	B
<b>Desk Height – Worksurface Support End — For use with Convergent Worksurface</b>	26.5"(673mm)	1.5"(38mm)	24"(610mm)	ZUFS-2427-LNF S	\$350.70	\$460.42
			30"(762mm)	ZUFS-3027-LNF S	397.74	507.46
			36"(914mm)	ZUFS-3627-LNF S	444.78	554.50
	27.5"(699mm)	1.5"(38mm)	24"(610mm)	ZUFS-2428-LNF S	\$362.46	\$472.18
			30"(762mm)	ZUFS-3028-LNF S	409.50	519.22
			36"(914mm)	ZUFS-3628-LNF S	456.54	566.26

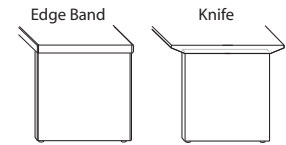
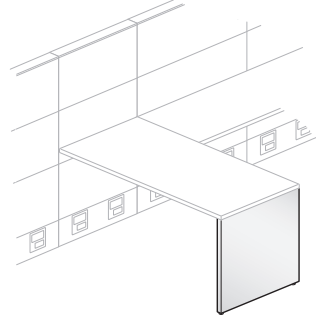

ZUFS

### Features

- Includes one worksurface support end with glides and attachment hardware.
- Installs beneath adaptable convergent worksurface.
  - Laminate surfaces with plastic edge trim, 3mm radiused user edge provides soft access to knee space.
- Adjustable glides provides a maximum of 2.5" (64mm) height adjustment range.
- Non-handed design.

### Specification Tips

- Provides full support for one end of equal depth adaptable convergent worksurface.
- Specify worksurface support end to match adaptable convergent worksurface edge option.
- Refer to Specification Guide for planning information.

### To Order, Specify:

- 1) Product number, including:

#### ① Edge Options:

- J Edgeband
- F Knife

- 2) Laminate surface color.
- 3) Edge trim color.

# Worksurface Support End

## 1H Worksurface Support End

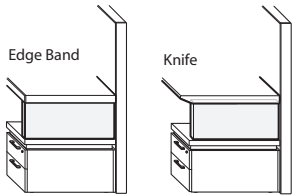
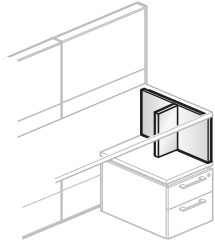

BZHU

Height	Nominal Depth	Number <sup>①</sup>	Laminate A	B
11"(279mm)	18"(457mm)	BZHU-1811-LNF	\$362.15	\$390.57
	24"(610mm)	BZHU-2411-LNF	389.04	419.62
	30"(762mm)	BZHU-3011-LNF	415.93	448.67
	36"(914mm)	BZHU-3611-LNF	442.82	477.72
12"(305mm)	18"(457mm)	BZHU-1812-LNF	\$362.15	\$390.57
	24"(610mm)	BZHU-2412-LNF	389.04	419.62
	30"(762mm)	BZHU-3012-LNF	415.93	448.67
	36"(914mm)	BZHU-3612-LNF	442.82	477.72

### Features

- Includes finished T-shaped support end panel and attachment hardware.
  - Laminate surfaces with plastic edgeband trim.
- Edge Options must match panel mounted worksurface edge.
- Provides worksurface end support; used with 1H storage.
- Non-handed design.

### Specification Tips

- 1H lower storage unit
  - Must have a separately specified Compose Storage top; attaches to lower storage unit at bench height.
  - May have finished or unfinished top or a spacer.
- 1H worksurface support end does not attach into Compose panel slots.
- Refer to Specification Guide for planning information.

### To Order, Specify:

- 1) Product number, including:

#### ① Edge Options:

- J Edgeband
- F Knife

- 2) Laminate surface color.
- 3) Edge trim color.

# Finish/Color Legend

<p><b>Laminate</b> <b>Grade A</b> <u>Solid Color</u> H-34 Beige H-AK Chalk H-8J Charcoal H-3J Graphite H-62 Gray Tone H-WL Linen H-3P Platinum H-AA Putty H-3E Smoke</p> <p><u>Patterned</u> H-P1 Linen Casual H-P2 Linen Classic H-P3 Linen Crisp H-P4 Linen Flax</p> <p><u>Wood Grain</u> H-AE Maple H-AD Medium Cherry</p> <p><b>Grade B</b> <u>Premium Wood Grain</u> H-KA Brazilwood H-KG Columbian Walnut H-KP Field Elm H-KN Grey Elm H-KM Landmark Wood H-KL Neo Walnut H-KC New Age Oak H-KR Phantom Ecru H-KS Phantom Pearl H-KD River Cherry H-KF Williamsburg Cherry</p>	<p><b>Edgeband</b> <u>Solid Color</u> HP-34 Beige HP-AK Chalk HP-8J Charcoal HP-3J Graphite HP-62 Gray Tone HP-WL Linen HP-3P Platinum HP-AA Putty HP-3E Smoke</p> <p><u>Patterned Edgeband</u> HP-P1 Linen Casual HP-P2 Linen Classic HP-P3 Linen Crisp HP-P4 Linen Flax</p> <p><u>Wood Grain</u> HP-KA Brazilwood HP-KG Columbian Walnut HP-KP Field Elm HP-KN Grey Elm HP-KM Landmark Wood HP-AE Maple HP-AD Medium Cherry HP-KL Neo Walnut HP-KC New Age Oak HP-KR Phantom Ecru HP-KS Phantom Pearl HP-KD River Cherry HP-KF Williamsburg Cherry</p> <p><u>Ply-Edge</u> HP-PW Ply-Edge</p>	<p><b>Trim</b> <b>Grade A</b> <u>Smooth</u> TR-R Beige TR-AK Chalk TR-K Charcoal TR-C1 Cocoa TR-J Graphite TR-G Gray Tone TR-AA Putty TR-E Smoke TR-PLS Smooth Plaster TR-FM Snow</p> <p><u>Textured</u> TR-TG Grout TR-TF Pitch TR-TW Plaster</p> <p><b>Grade B</b> <u>Smooth</u> TR-1C Accent Blue TR-1G Blue Jay TR-1R Brownstone TR-1N Night TR-1Q Park TR-RR Rusty Red TR-1M Sable TR-1J Sky Blue</p> <p><u>Smooth Metallic</u> TR-MC Metallic Champagne TR-LE Metallic Silver</p> <p><u>Textured Metallic</u> TR-HE Hellenic</p>	<p><b>Lock Plugs</b> LR-BL Black LR-BP Chrome</p>	<p><b>ALERT:</b> These materials are current, however they are being considered for future obsolescence due to low volume.</p> <div style="border: 1px solid black; padding: 5px; margin-bottom: 5px;"> <p><b>Laminate:</b> H-AM Amber Cherry</p> </div> <div style="border: 1px solid black; padding: 5px; margin-bottom: 5px;"> <p><b>Edgeband:</b> HP-AM Cherry</p> </div> <div style="border: 1px solid black; padding: 5px;"> <p><b>Trims:</b> TR-1E Accent Orange TR-1F Accent Red TR-AR Argent TR-CTS Chartreuse TR-DM Dark Bronze Metallic TR-1H Terra TR-1K Wren</p> </div>
--	--	--	---	--



# Seating Fabrics/Color Legend

## Seating Fabrics

### Grade A

Blanket (4H)  
Hobson (3J)  
Morse (4J)  
Novelty (3L)  
Pixel (2A)  
Tellure (3A)  
Wellington Faux Leather (XJ)

### Grade B

Diagonale (4N)  
Element (4Z)  
English Tweed (4E)  
Floyd by Kvadrat (S6)  
Kaleidoscope (S4)  
Pemberton (SN)  
Ramie (4V)  
Reflect by Kvadrat (S8)  
Squares (RA)

### Grade C

Dots (6K)  
King II (67)  
Maya II (68)  
Oceanic (4T)  
Scapes (3S)

### Grade D

Atlas by Kvadrat (LW)  
Big Arrow (4D)  
Big Diagonale (1K)  
Clara 2 by Kvadrat (NV)  
Class II (66)  
Cotswold (JB)  
Main Line Flax (6M)  
Melange Nap by Kvadrat (S7)  
Recheck by Kvadrat (RP)

### Grade E

Brisa Faux Leather (XG)  
Steelcut Trio 3 by Kvadrat (SY)

### Grade F

Divina Melange 3 by Kvadrat (SV)  
Hallingdal 65 by Kvadrat (SZ)

**ALERT:** These materials are current, however they are being considered for future obsolescence due to low volume.

### Seating Fabrics

#### Grade A

Twist (MM)

#### Grade B

Gauge (1X)

Tech (MV)

#### Grade D

Tangram (LV)

### Haworth+

For information on the Haworth+ alliance program, including images and product availability, please refer to:  
Haworth.com > Surface Collection > Haworth+ Library

### Customer's Own Material (COM)

For general Customer's Own Material (COM) information including processes and forms, please refer to:  
Haworth.com > Surface Collection > Resources > COM  
For information on approved COM's, please refer to:  
Haworth.com > Surface Collection > COM Library

\* For most current finish and fabric availability please reference [surfaces.haworth.com](https://surfaces.haworth.com).

# Index

Products are listed alphabetically in this index by alpha-numeric prefix/suffix codes.

<b>Product Code</b>	<b>Product Description</b>	<b>Page</b>
BZAB	Finished Back	40
BZAH	Lateral File/Storage Accessories – Lateral File Hanging Bar	20
BZBG	Lateral File/Storage Accessories – Storage-to-Panel Bracket	20
BZBG	Pedestal Accessories – Storage-to-Panel Bracket	12
BZDL-WNNNSNN	Stack-on Storage	38
BZHU	Worksurface Support End – One-high Worksurface Support End	43
BZKL-WWFTSLN	Stack-on Storage	38
BZKL-WWPTSLN	Stack-on Storage	38
BZL1	Lateral Files	13
BZL2	Lateral Files	13
BZL3	Lateral Files	13
BZLA	Lateral Files	13
BZLB	Combination Unit	18
BZLC	Combination Unit	18
BZLV	Open Shelf Lateral File	16
BZLZ	Open Shelf Lateral File	16
BZMA-CLN	Mobile Pedestals	8
BZMA-GLN	Mobile Pedestals	8
BZMH-CLN	Mobile Pedestals	8
BZMH-GLN	Mobile Pedestals	8
BZMJ-CLN	Mobile Pedestals	8
BZMJ-GLN	Mobile Pedestals	8
BZPA	Pedestals	10
BZPH	Pedestals	10
BZPJ	Pedestals	10
BZPX	Pedestals	10
BZRH-4924-LQL	Personal Storage Tower with Side Bookcase	29
BZRH-4924-LQR	Personal Storage Tower with Side Bookcase	29
BZSC-F	Lateral File/Storage Accessories – File/Storage Cushion	20
BZSC-F	Pedestal Accessories – Pedestal Cushion	12
BZSN-WN1N	Storage Unit without Doors	26
BZSN-WN2N	Storage Unit without Doors	26
BZSN-WN3N	Storage Unit without Doors	26
BZSS-WW1T	Storage Unit with Doors	24
BZSS-WW2T	Storage Unit with Doors	24
BZSS-WW3T	Storage Unit with Doors	24
BZTB-1862	Continuous Storage Tops	22
BZTM-1836	Off-Modular Storage Tops	23
BZTR-1830	Individual/Common Storage Tops	21
BZTR-1860	Individual/Common Storage Tops	21
BZTR-3660	Individual/Common Storage Tops	21
BZVH-NL	Personal Storage Tower with Wardrobe	33
BZVH-NR	Personal Storage Tower with Wardrobe	33
BZWK-LNL	Wardrobes – Wardrobes	36
BZWK-LNL	Wardrobes – Wardrobes	36
BZWK-LNR	Wardrobes – Wardrobes	36
JPTA-6	Pedestal Accessories – Pencil Tray	12
ZUFS	Worksurface Support End	42
ZZFS	Worksurface Support Panel	41

## Product Compatibility and Limited Warranty Policy

### Great Expectations

You have them as a Haworth customer and so do we. And because we value our customers, we cover our products with the Haworth North America Product Compatibility and Limited Warranty Policy.

### Our Commitment To Product Compatibility – Integrated Product Platforms

As a market leader in the design and manufacture of workspaces that adapt to change, we strive to maintain product compatibility within our various generations of integrated product platforms. This benefits the customer who desires to update or modify their work environment. It also benefits the customer needing to replace a product due to damage or other reasons but which is no longer manufactured or is otherwise unavailable, such as a fabric or finish that is discontinued because of changing market preferences. In both circumstances, we often can provide products with comparable function and performance.

### Our Commitment To Product Quality – The Haworth North America Limited Warranty

To ensure customer satisfaction and peace of mind, we stand behind our products with the Haworth North America Limited Warranty. To review the current version of the limited warranty including its terms and conditions, please go to:

**[www.haworth.com/warranty](http://www.haworth.com/warranty) or contact [OneTouch@Haworth.com](mailto:OneTouch@Haworth.com) or 1 877 429 6784.**

### Warranty Requests or Questions

For questions or service requests pertaining to the Haworth Limited Warranty, please contact your Haworth dealer. If you are unsure who your dealer is, please contact **[OneTouch@Haworth.com](mailto:OneTouch@Haworth.com) or 1 877 429 6784.**

**Effective: September 1, 2021**

# HAWORTH

HAWORTH® is a registered trademark of Haworth, Inc.

© Haworth, Inc. All rights reserved. 2023 8.23

[haworth.com](http://haworth.com) | 800 344 2600