

HAWORTH

Collaborate

North America Price List – February 2024





This Haworth North American price book contains US list prices.

Canadian customers can convert the US list price into their Canadian equivalent by going to www.Haworth.com/Canada to find the current Canadian multipliers. These multiplier factors allow you to convert the US list price into a Canadian list price.

Haworth Price Book Overview

Tips for Using Haworth Price Lists

The following overview explains how information is organized within the Collaborate™ price list.

Navigation Links

Use the links to jump back and forth to relevant pages.

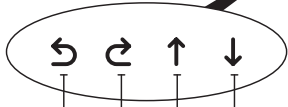

Go Back (in page history)

Go Forward (in page history)

Previous Page (minus 1 page)

Next Page (plus 1 page)

Page Tabs

Use color coded tabs at the top of each page to determine which section you are in.

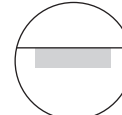

Grey Tab
Price List
Section

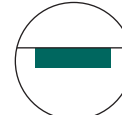

Green Tab
Resources
Section

Haworth Price Books are organized into the following sections:

Price List Section

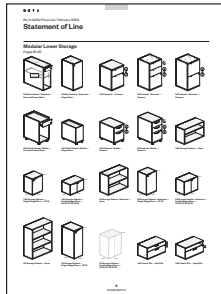

Statement of Line

Provides a visual overview of the product offering.

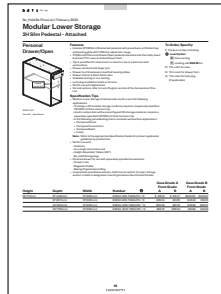

Price List

Includes product features, specification tips, catalog numbers and list pricing.

Resources Section

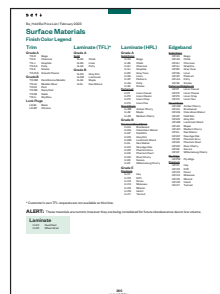

Finishes and Fabrics

Lists available finishes and fabrics.

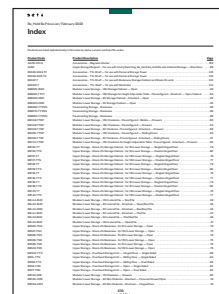

Index

Lists products alphabetically by catalog number.



Warranty and Terms of Sale

Provides warranty information and general terms.

Table of Contents

Price List

Statement of Line	6
Team Cart	8
Board Cart	9
Cart Accessories	
Drawer	10
Pivoting Tray	10
Collaborate Tablet	
Markerboard	11
Markerboard Accessories	11
Markerboard Rail	12
Freestanding Screens	
Laminate and Markerboard	13
Fabric	14
Screen Accessories	
Personal Hook	15
Monitor Hook	15
Fabrics and Finishes	
Finish/Color Legend	17
Vertical Fabrics/Color Legend	18
Index	19
Lifetime Product Warranty	Inside Back Cover

Collaborate Price List

Includes pricing, catalog numbers, finish codes/availability, specification requirements, line art, dimensions, and specification tips for Collaborate.

Team Cart

Board Cart

Cart Accessories

Freestanding Screens

Screen Accessories

Statement of Line

Team Cart

Page 8



CLOT-LNC



CLOT-LSC

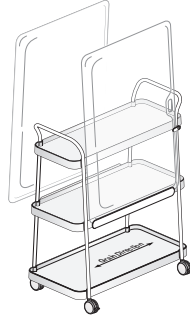

CLOT-LDC

Board Cart

Page 9



CLCB-LNC



CLCB-LSC

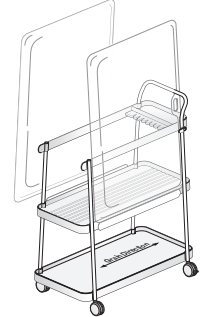

CLCB-LDC

Cart Accessories

Page 10

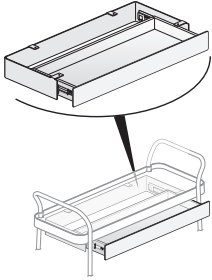

CLCD-P
Drawer

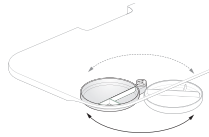

ATTR
Pivoting Tray

Collaborate Tablet

Pages 11-12

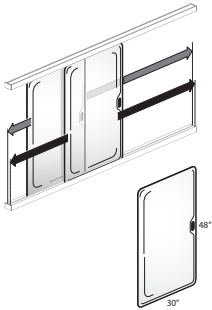

ATTM
Markerboard

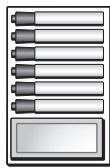

7062-8001
Markerboard Accessories



7031-7002
Markerboard Accessories



7031-7001
Markerboard Accessories

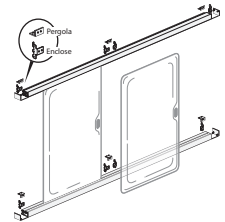

ATMR
Markerboard Rail

Freestanding Screens

Pages 13-14

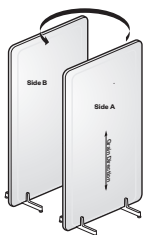

CLSF-LNN
Laminate and
Markerboard

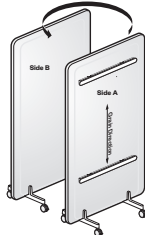

CLSF-LNS
Laminate and
Markerboard

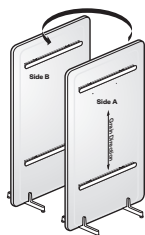

CLSF-LND
Laminate and
Markerboard



CLSF-2NN
Fabric



CLSF-2MN
Fabric



CLSF-2MS
Fabric



CLSF-2ND
Fabric

Statement of Line

Personal Hook

Page 15

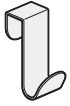

CLHP-LP1

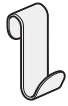

CLHP-SP1

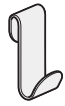

CLHP-2P1



CLHP-LP2



CLHP-SP2



CLHP-2P2

Monitor Hook

Page 15

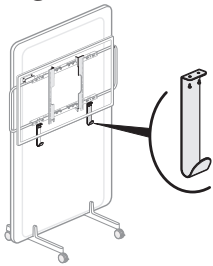

CLHM-P
Monitor Hook

Team Cart



CLCT-LNC



CLCT-LSC

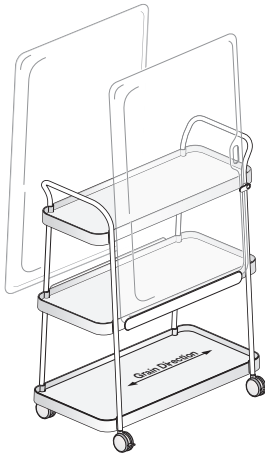

CLCT-LDC

Class QA6 - GSA; Open Market

Features

- Includes one painted metal cart on casters with three high-pressure laminate shelves and optional markerboard rail(s).
- Pivot casters - two locking and two non-locking. Available in Black (TR-F), Fog (TR-7), or Platinum (TR-LPL).
- Each shelf is 0.75"(19mm) thick.

Specification Tips

- Shelves are predrilled to for markerboard rail(s) and separately specified accessory drawer.
- Shelf Dimensions:
 - Top: 36.49"(927mm)L x 13.99"(355mm)W
 - Middle: 36.49"(927mm)L x 15.83"(402mm)W
 - Bottom: 36.49"(927mm)L x 17.84"(453mm)W
- Markerboard rail:
 - Matches horizontal frame color.
 - Installs on middle shelf.
 - Markerboard rail specification includes matching retainer clip.
 - Maximum one markerboard per rail.
 - Accommodates Collaborate Tablet Medium Markerboard ATTM-3048-NH only.
 - Must be specified at order placement. Rail cannot be modified or added in the field.
 - Accommodates Belong Tool Cup.
- Separately specified accessories:
 - Cart Accessory Drawer (CLCD-P) or Compose Echo Pivoting Tray (ATTR-1301-L).
 - Mount on top or middle shelf.
 - Maximum one accessory per shelf.
 - Cannot be installed on the same shelf and side as a markerboard rail.
 - Belong Tool Cup (KUTC-0000-H).
- Edgeband available in solid colors only.*
- Ships fully assembled.

Note: Shelf edgeband is concealed by horizontal shelf trim and is only visible from a top down view.

To Order, Specify:

- 1) Product number.
- 2) Laminate color.
- 3) Solid edgeband color.*
- 4) Horizontal frame color.
- 5) Vertical frame color.
- 6) Caster color.

Description	Height	Depth	Width	Number	HPL A Trim		HPL B Trim		HPL E Trim	
					A	B	A	B	A	B
No Markerboard Rail	45"(1143mm)	20"(508mm)	36"(914mm)	CLCT-LNC	\$ 2115.00	\$ 2170.00	\$2245.31	\$2300.31	\$ 2748.79	\$2803.79
Single Markerboard Rail				CLCT-LSC	2395.00	2450.00	2525.31	2580.31	3028.79	3083.79
Double Markerboard Rail				CLCT-LDC	2675.00	2730.00	2805.31	2860.31	3308.79	3363.79

Board Cart

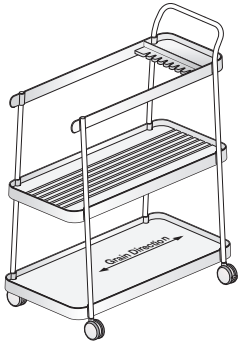

CLCB-LNC

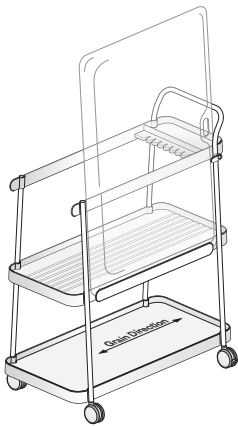

CLCB-LSC

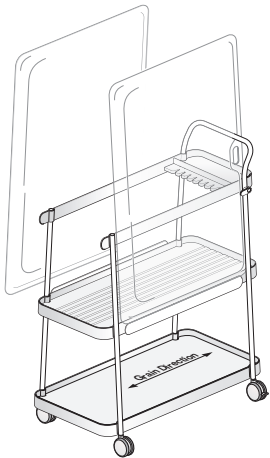

CLCB-LDC

Class QA6 - GSA; Open Market

Features

- Includes one painted metal cart on casters with two high-pressure laminate shelves, board management tray and comb, marker/eraser tray, and optional markerboard rail(s).
- Pivot casters - two locking and two non-locking. Available in Black (TR-F), Fog (TR-7), or Platinum (TR-LPL).
- Each shelf is 0.75"(19mm) thick.
- Marker and eraser tray location below handle is painted to match horizontal frame color.
- Top shelf includes board management tray.
- Board management tray and comb available in PET (Polyethylene Terephthalate) in Dusk (PET-C1) or Mink (PET-C4).
- Cart holds up to nine markerboards. Seven store on the board management tray and allows for one in the markerboard rail on each side of the cart.

Specification Tips

- Shelves are predrilled to for markerboard rail(s) and separately specified accessory drawer.
- Shelf Dimensions:
Top: 36.49"(927mm)L x 15.83"(402mm)W
Bottom: 36.49"(927mm)L x 17.84"(453mm)W
- Markerboard rail:
 - Matches horizontal frame color.
 - Installs on top shelf on one or both sides of the cart. When a single markerboard rail is specified, the rail and retainer clip will be installed on the user's left-hand side when facing handle.
 - Markerboard rail specification includes matching retainer clip.
 - Maximum one markerboard per rail.
 - Must be specified at order placement. Rail cannot be modified or added in the field.
 - Accommodates Belong Tool Cup.
- Board management tray and markerboard rails accommodate Collaborate Tablet Medium Markerboard ATTM-3048-NH only; separately specified.
- Separately specified accessories:
 - Cart Accessory Drawer (CLCD-P) or Compose Echo Pivoting Tray (ATTR-1301-L).
 - Mounts on top shelf.
 - Maximum one accessory per shelf.
 - Cannot be installed on the same side as markerboard rail.
 - Belong Tool Cup (KUTC-0000-H).
- Edgeband available in solid colors only.*
- Ships fully assembled.

Note: Shelf edgeband is concealed by horizontal shelf trim and is only visible from a top down view.

To Order, Specify:

- 1) Product number.
- 2) Laminate color.
- 3) Solid edgeband color.*
- 4) Horizontal frame color.
- 5) Vertical frame color.
- 6) PET color.
- 7) Caster color.

Description	Height	Depth	Width	Number	HPL A Trim		HPL B Trim		HPL E Trim	
					A	B	A	B	A	B
No Markerboard Rail	45"(1143mm)	20"(508mm)	36"(914mm)	CLCB-LNC	\$ 1975.00	\$ 2030.00	\$ 2225.15	\$ 2280.15	\$ 3191.65	\$ 3246.65
Single Markerboard Rail				CLCB-LSC	2255.00	2310.00	2505.15	2560.15	3471.65	3526.65
Double Markerboard Rail				CLCB-LDC	2535.00	2590.00	2785.15	2840.15	3751.65	3806.65

Cart Accessories

Drawer

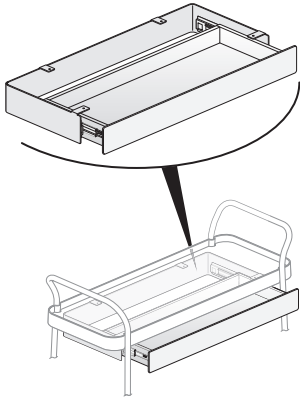

CLCD-P
Class QA6 - GSA; Open Market

Features

- Includes one black miterfold non-locking drawer with painted metal front and drawer housing.
- Attaches to the top or middle shelf of the Team Cart or top shelf of Board Cart.

Specification Tips

- One drawer can be mounted per shelf.
- Drawer cannot be mounted on same side as a Markerboard Rail.
- When attaching two drawers to a Team Cart, drawers may be mounted on same side or alternate sides.

To Order, Specify:

- 1) Product number.
- 2) Front/Case trim.

Height	Depth	Width	Number	Trim	
				A	B
3"(76mm)	14"(356mm)	30"(762mm)	CLCD-P	\$325.00	\$350.00

Pivoting Tray

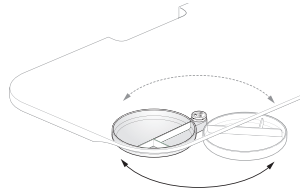

ATTR
Class TR01 - Discount Group XXXII

Features

- Includes one round plastic tray and mounting hardware.
- Available in Brownstone and Smooth Plaster.
- Mounts to laminate or veneer surfaces .75"(19mm) or thicker.
- Tray is 13"(330mm) in Diameter.

Specification Tips

- Will mount underneath cart shelf and pivot out.
- Must be mounted on the opposite side of the Team/Board Cart markerboard rail.
- Cannot be mounted on the same shelf as an Accessory Drawer.
- Part is non-handed.
- Max weight 5 lbs.

To Order, Specify:

- 1) Product number.
- 2) Trim color.
TR-PLS Smooth Plaster (Grade A)
TR-1R Brownstone (Grade B)

Number	Trim	
	A	B
ATTR-1301-L	\$98.10	\$103.55

Collaborate Tablet Markerboard

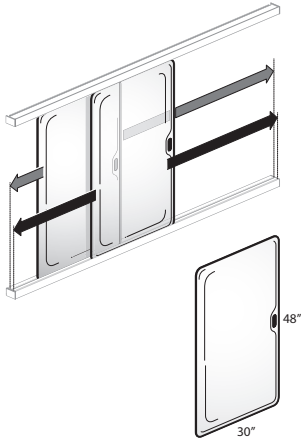

ATTM
Class TR01 – Discount Group XXXII

Features

- Includes one markerboard with handle.
- Designed to be lightweight and portable.
- Medium Markerboard (30”(762mm) x 48”(1219mm)) is designed for use with the separately specified Markerboard Rail, Team Cart or Board Cart.
- Markerboard surface is not magnetic.

Specification Tips

- Designed with handles for safe and secure transport.
- **The following products are recommended to maintain the markerboard appearance:**
 - Dry erase marker kit (includes holder, six markers and eraser), order part# 7062-8001.
 - Markerboard cleaner and conditioner, order part# 7031-7001.
 - Markerboard spray cleaner, order part# 7031-7002.
- Not recommended for areas exposed to high temperatures or exterior use.

To Order, Specify:

- 1) Product number.

Description	Height	Width	Weight	Number	Price
Handle					
Medium Markerboard	30”(762mm)	48”(1219mm)	9 lbs.	ATTM-3048-NH	\$425.82

Markerboard Accessories

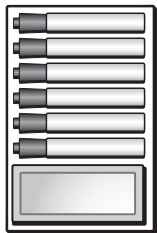

7062-8001

Feature

- Recommended dry erase marker products to maintain, clean & condition markerboards.

To Order, Specify:

- 1) Product number.
(no finish specification required.)

Description

Description	Number	Price
Dry Erase Marker Kit (holder, six markers and eraser)	7062-8001	\$200.28
Cleaner and Conditioner	7031-7001	239.12
Spray Cleaner	7031-7002	72.99



7031-7002



7031-7001

Collaborate Tablet

Markerboard Rail

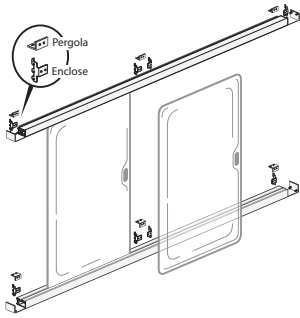

ATMR
Class TR01 – Discount Group XXXII

Features

- Includes painted metal top and bottom rails and end caps.
- Enclose and Pergola Mount include attachment hardware.
- Wall Mounting hardware is field supplied.
- Rails can be field cut to desired width.

Specification Tips

- Designed to be used with Medium Markerboard (30"(762mm) x 48"(1219mm)) in an upright/portrait orientation.
- Each Rail includes a front and back channel, allowing (2) markerboards to bypass each other.
- The 96"(2438mm)W rails can accommodate a maximum of (4) Medium Markerboards (30"(762mm) x 48"(1219mm)).
 - (2) Medium Markerboards in the front channel.
 - (2) Medium Markerboards in the rear channel.
- Rail support rules by application:
 - Enclose Mount:
 - Not more than 24"(610mm) of top/bottom rail overhang past the outer brackets.
 - Pergola Mount:
 - Requires Pergola Horizontal Tile at Seated Height for application.
 - Not more than 8"(203mm) top/bottom rail overhang past the outer brackets.
 - Wall Mount:
 - Not more than 16"(406mm) of top/bottom rail overhang past the outer attachment points.
- Enclose and Pergola require three points of attachment per mounting rail. Maximum Enclose panel width between brackets is 48"(1219mm).
- Wall Mount requires one rail attachment point every 16"(406mm)-18"(457mm).
- Can be used with Belong Tool Cup to manage markers (KUTC-0000-H).

To Order, Specify:

- 1) Product number.
- 2) Trim color.

Description	Width	Number	Trim	
			A	B
Enclose Mount	96"(2438mm)	ATMR-0096-PEN	\$ 861.10	\$866.55
Pergola Mount		ATMR-0096-PPN	893.80	899.25
Wall Mount		ATMR-0096-PWN	795.70	801.15

Freestanding Screens

Laminate and Markerboard

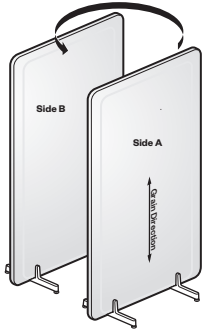

CLSF-LNN

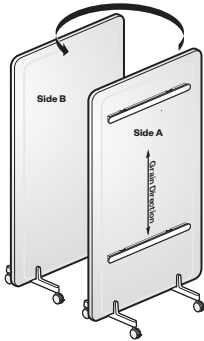

CLSF-LNS

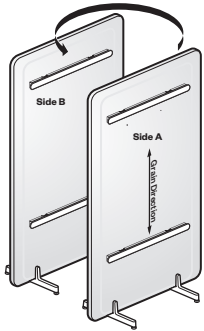

CLSF-LND
Class QA6 - GSA; Open Market

Features

- Includes one high-pressure laminate (HPL) or markerboard screen with 1mm edgeband with base, leveling glides or casters and optional markerboard rails.
- Caster option includes two locking pivot casters and two non-locking pivot casters in Black (TR-F), Fog (TR-7), or Platinum (TR-LPL).
- Optional single or dual markerboard rail option available on 82"(2083mm)H screens only.

Specification Tips

- Markerboard Rail option must be specified at time of order placement. Cannot be retrofitted in the field. Rail color will match base.
- Optional Markerboard Rails accommodate separately specified Collaborate Tablet Medium Markerboard ATTM-3048-NH only.
- For use with separately specified personal hook.
- Monitor mount not available on laminate or markerboard screens.
- Markerboard rail accommodates Belong Tool Cup (KUTC-0000-H).

To Order, Specify:

1) Product number, including:

1 Markerboard Rails Option:

- N** No Markerboard Rails
- S** Single Markerboard Rails 82"(2083mm)H only (add **\$280.00** list)
- D** Dual Markerboard Rails 82"(2083mm)H only (add **\$560.00** list)

2 Caster/Glide Option:

- C** Casters
- G** Glides

2) Laminate color (if applicable).

3) Edgeband color.

4) Base color.

5) Caster color (if applicable).

Height	Width	Number ①②	HPL A Trim		HPL B Trim		HPL E Trim	
			A	B	A	B	A	B
Laminate								
58"(1473mm)	36"(914mm)	CLSF-5836-LNN	\$1339.84	\$1364.84	\$1525.71	\$1550.71	\$2243.21	\$2268.21
	42"(1067mm)	CLSF-5842-LNN	1409.92	1434.92	1607.25	1632.25	2369.03	2394.03
	48"(1219mm)	CLSF-5848-LNN	1480.00	1505.00	1688.79	1713.79	2494.85	2519.85
82"(2083mm)	36"(914mm)	CLSF-8236-LN	\$1480.00	\$1505.00	\$1688.91	\$1713.91	\$2494.97	\$2519.97
	42"(1067mm)	CLSF-8242-LN	1550.08	1575.08	1770.45	1795.45	2620.79	2645.79
	48"(1219mm)	CLSF-8248-LN	1620.16	1645.16	1851.99	1876.99	2746.61	2771.61
Markerboard								
58"(1473mm)	36"(914mm)	CLSF-5836-MNN					\$1409.84	1434.84
	42"(1067mm)	CLSF-5842-MNN					1479.92	1504.92
	48"(1219mm)	CLSF-5848-MNN					1550.00	1575.00
82"(2083mm)	36"(914mm)	CLSF-8236-MN					\$1550.00	1575.00
	42"(1067mm)	CLSF-8242-MN					1620.08	1645.08
	48"(1219mm)	CLSF-8248-MN					1690.16	1715.16

Freestanding Screens

Fabric

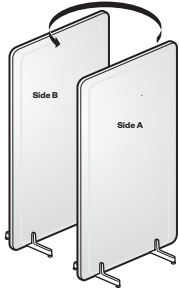

CLSF-2NN

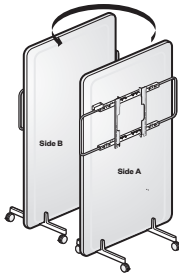

CLSF-2MN

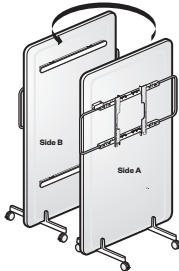

CLSF-2MS

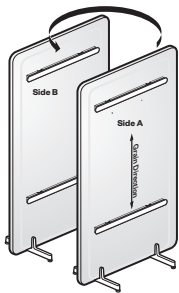

CLSF-2ND

Class QA6 - GSA; Open Market

Features

- Includes one tackable fabric screen with bases on leveling glides or casters and option markerboard rails and/or monitor mount.
- Caster option includes two locking pivot casters and two non-locking pivot casters. Casters available in Black (TR-F), Fog (TR-7), or Platinum (TR-LPL)
- Markerboard rails available on 82"(2083mm)H screens only.
- Optional Monitor Mount available on screens 82"(2083mm)H x 42"(1067mm)W and 82"(2083mm)H x 48"(1219mm)W.

Specification Tips

- Markerboard Rail and/or monitor mount option must be specified at time of order placement. Cannot be retrofitted in the field. Rail color will match base.
- Optional Markerboard Rails accommodate separately specified Collaborate Tablet Medium Markerboard ATTM-3048-NH only.
- Dual Markerboard Rails cannot be ordered in combination with Monitor Mount.
- Fabric screen has NRC of 0.7.
- Monitor mount:
 - Screens with monitor mount utilize longer feet than those without a monitor mount.
 - Includes a remote holder.
 - Handles will match base color.
 - Maximum weight capacity 45 pounds.
 - Recommend 43"(1092mm)-50"(1270mm) monitor on 42"(1067mm)W screen and 50"(1270mm)-55"(1397mm) monitor on 48"(1219mm)W screen.
 - Monitor mount cannot be specified on screen with dual markerboard rails.
 - Monitor Hook available; separately specified.
- For use with separately specified personal hook.
- Markerboard rail accommodates Belong Tool Cup (KUTC-0000-H)

To Order, Specify:

1) Product number, including:

1 Markerboard Rails Option:

- N** No Markerboard Rails
- S** Single Markerboard Rails 82"(2083mm)H only (add **\$280.00** list)
- D** Dual Markerboard Rails 82"(2083mm)H only (add **\$560.00** list)

2 Caster/Glide Option:

- C** Casters
- G** Glides

2) Fabric color.
3) Base color.
4) Caster color (if applicable).

Fabric

Height	Width	Number	1 2	A	B	C	D	E	F	G	H
No Monitor Mount											
58"(1473mm)	36"(914mm)	CLSF-5836-2NN		\$ 1794.84	\$2036.83	\$2302.95	\$2592.99	\$2883.38	\$ 3270.44	\$ 3512.31	\$3899.38
	42"(1067mm)	CLSF-5842-2NN		1864.92	2117.59	2395.41	2698.23	3001.40	3405.56	3658.05	4062.22
	48"(1219mm)	CLSF-5848-2NN		1935.00	2198.35	2487.87	2803.47	3119.42	3540.68	3803.79	4225.06
82"(2083mm)	36"(914mm)	CLSF-8236-2N		\$ 1935.00	\$ 2198.35	\$ 2487.99	\$2803.47	\$ 3119.54	\$3540.68	\$ 3803.91	\$4225.06
	42"(1067mm)	CLSF-8242-2N		2005.08	2279.11	2580.45	2908.71	3237.56	3675.80	3949.65	4387.90
	48"(1219mm)	CLSF-8248-2N		2075.16	2359.87	2672.91	3013.95	3355.58	3810.92	4095.39	4550.74
Monitor Mount											
82"(2083mm)	42"(1067mm)	CLSF-8242-2M		\$ 2780.08	\$ 3054.11	\$3355.45	\$ 3683.71	\$4012.56	\$4450.80	\$ 4724.65	\$ 5162.90
	48"(1219mm)	CLSF-8248-2M		2850.16	3134.87	3447.91	3788.95	4130.58	4585.92	4870.39	5325.74

Screen Accessories

Personal Hook

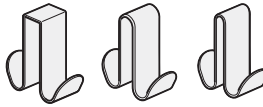
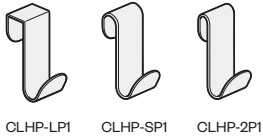

CLHP-LP2 CLHP-SP2 CLHP-2P2
Class QA6 - GSA; Open Market

Features

- Includes one painted steel personal hook with flocked protective pads.
- Personal hook designed to hold a coat or bag.
- Available as single-sided or dual-sided.
- Flocked pads protect screen and hold hook in place.

Specification Tips

- Not for use on Compose Echo screens.
- 1.25"(32mm)D for use on laminate Collaborate Freestanding Screens and Compose Gallery panels.
- 1"(25mm)D for use on Cabana Lounge and Openest screens.
- 0.6"(15mm)D for use on fabric Collaborate Freestanding Screens.
- Hook has a 10 lb weight capacity per side.

To Order, Specify:

- 1) Product number.
- 2) Trim color.

Description	Height	Depth	Width	Number	Trim	
					A	B
Collaborate Freestanding Screen (Laminate) / Compose Gallery Panel						
Single	4.88"(124mm)	1.25"(32mm)	2"(51mm)	CLHP-LP1	\$45.00	\$50.00
Double				CLHP-LP2	50.00	55.00
Cabana Lounge / Openest Screen						
Single	4.88"(124mm)	1"(25mm)	2"(51mm)	CLHP-SP1	\$45.00	\$50.00
Double				CLHP-SP2	50.00	55.00
Collaborate Freestanding Screen (Fabric)						
Single	4.88"(124mm)	0.6"(15mm)	2"(51mm)	CLHP-2P1	\$45.00	\$50.00
Double				CLHP-2P2	50.00	55.00

Monitor Hook

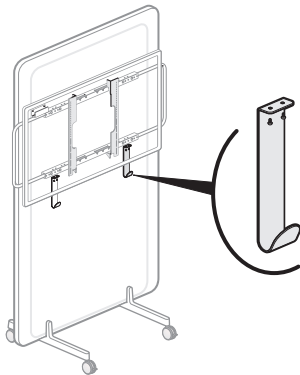

CLHM-P
Class QA6 - GSA; Open Market

Features

- Includes one painted steel monitor hook.

Specification Tips

- For use with Collaborate Freestanding fabric screens with monitor mount only.
- Attaches to Collaborate Monitor Mount handle assembly.
- Monitor mount accepts one hook per side.
- 10 lb weight capacity per hook. Use for cord management or to hang small objects.

To Order, Specify:

- 1) Product number.
- 2) Trim color.

Description	Height	Depth	Width	Number	Trim	
					A	B
CLHM-P	9.05"(230mm)	1.125"(29mm)	2"(51mm)	CLHM-P	\$50.00	\$55.00

HAWORTH

Collaborate Resources

Surfaces Materials

Index

Warranty

Surface Materials

Finish Color Legend

Laminate Finishes

Grade A

Solid Color

H-34	Beige
H-AK	Chalk
H-8J	Charcoal
H-3J	Graphite
H-62	Gray Tone
H-WL	Linen
H-3P	Platinum
H-AA	Putty
H-3E	Smoke

Patterned

H-P1	Linen Casual
H-P2	Linen Classic
H-P3	Linen Crisp
H-P4	Linen Flax

Wood Grain

H-AE	Maple
------	-------

Grade B

Premium Wood Grain

H-KA	Brazilwood
H-KG	Columbian Walnut
H-KP	Field Elm
H-KN	Grey Elm
H-KM	Landmark Wood
H-KL	Neo Walnut
H-KC	New Age Oak
H-KR	Phantom Ecru
H-KS	Phantom Pearl
H-KD	River Cherry
H-KF	Williamsburg Cherry

Grade E

Premium

H-C2	Drift
H-C6	Hatch
H-C1	Hay
H-C5	Mineral
H-C4	Molasses
H-C3	Pecan
H-C7	Tanned

Edgeband

Solid Color

HP-34	Beige
HP-AK	Chalk
HP-8J	Charcoal
HP-3J	Graphite
HP-62	Gray Tone
HP-WL	Linen
HP-3P	Platinum
HP-AA	Putty
HP-3E	Smoke

Patterned Edgeband

HP-P1	Linen Casual
HP-P2	Linen Classic
HP-P3	Linen Crisp
HP-P4	Linen Flax

Wood Grain

HP-KA	Brazilwood
HP-KG	Columbian Walnut
HP-KP	Field Elm
HP-KN	Grey Elm
HP-KM	Landmark Wood
HP-AE	Maple
HP-KL	Neo Walnut
HP-KC	New Age Oak
HP-KR	Phantom Ecru
HP-KS	Phantom Pearl
HP-KD	River Cherry
HP-KF	Williamsburg Cherry

Premium

HP-C2	Drift
HP-C6	Hatch
HP-C1	Hay
HP-C5	Mineral
HP-C4	Molasses
HP-C3	Pecan
HP-C7	Tanned

Ply-Edge

HP-PW	Ply-Edge
-------	----------

Trim

Grade A

Smooth

TR-R	Beige
TR-F	Black
TR-AK	Chalk
TR-K	Charcoal
TR-C1	Cocoa
TR-J	Graphite
TR-G	Gray Tone
TR-AA	Putty
TR-E	Smoke
TR-PLS	Smooth Plaster
TR-FM	Snow

Textured

TR-TG	Grout
TR-TF	Pitch
TR-TW	Plaster

Grade B

Smooth

TR-1G	Blue Jay
TR-1R	Brownstone
TR-1N	Night
TR-1Q	Park
TR-RR	Rusty Red
TR-1M	Sable
TR-1J	Sky Blue

Smooth Metallic

TR-HE	Hellenic
TR-MC	Metallic Champagne
TR-MG	Metallic Gunmetal
TR-LE	Metallic Silver

Casters

TR-F	Black
TR-7	Fog
TR-LPL	Light Platinum

PET Finishes

PET-C1	Dusk
PET-C4	Mink

ALERT: These materials are current, however they are being considered for future obsolescence due to low volume.

Laminate

H-AM	Amber Cherry
H-AD	Medium Cherry

Edgeband

HP-AM	Amber Cherry
HP-AD	Medium Cherry

Trims

TR-CTS	Chartreuse
TR-DM	Dark Bronze Metallic
TR-1H	Terra
TR-1K	Wren

Surface Materials

Fabrics/Color Legend

Vertical Fabrics

Grade A

- (36) Aerial
- (6X) Chevron
- (35) Etch
- (L6) Highlands
- (C1) Striae
- (PY) Tailored
- (3A) Tellure

Grade B

- (4HV) Blanket
- (33) Camp
- (L5) Classic
- (34) Fields
- (6) Hue
- (2AV) Pixel
- (WS) Shimmer

Grade C

- (SW) Sisal

Grade D

- (4NV) Diagonale
- (67V) King II

Grade E

- (68V) Maya II
- (S6V) Floyd by Kvadrat

Grade G

- (66V) Class II
- (JBV) Cotswold
- (4TV) Oceanic

Grade H

- (S7V) Melange Nap by KVadrat

* For most current finish and fabric availability please reference surfaces.haworth.com.

Haworth+

For information on the Haworth+ alliance program, including images and product availability, please refer to: [Haworth.com](https://www.haworth.com) > Surface Collection > Haworth+ Library

Customer's Own Material (COM)

For general Customer's Own Material (COM) information including processes and forms, please refer to: [Haworth.com](https://www.haworth.com) > Surface Collection > Resources > COM

For information on approved COM's, please refer to: [Haworth.com](https://www.haworth.com) > Surface Collection > COM Library

Index

Products are listed alphabetically in this index by alpha-numeric prefix/suffix codes.

Product Code	Product Description	Page
7031-7001	Collaborate Tablet – Markerboard Accessories	.11
7031-7002	Collaborate Tablet – Markerboard Accessories	.11
7062-8001	Collaborate Tablet – Markerboard Accessories	.11
ATMR	Compose Echo Table	.12
ATTM	Collaborate Tablet	.11
ATTR	Cart Accessories – Pivoting Tray	.10
CLCB-LDC	Board Cart	.9
CLCB-LNC	Board Cart	.9
CLCB-LSC	Board Cart	.9
CLCD-P	Cart Accessories – Drawer	.10
CLCT-LDC	Team Cart	.8
CLCT-LNC	Team Cart	.8
CLCT-LSC	Team Cart	.8
CLHM-P	Screen Accessories – Monitor Hook	.15
CLHP-2P1	Screen Accessories – Personal Hook	.15
CLHP-2P2	Screen Accessories – Personal Hook	.15
CLHP-LP1	Screen Accessories – Personal Hook	.15
CLHP-LP2	Screen Accessories – Personal Hook	.15
CLHP-SP1	Screen Accessories – Personal Hook	.15
CLHP-SP2	Screen Accessories – Personal Hook	.15
CLSF-2MN	Freestanding Screens	.14
CLSF-2MS	Freestanding Screens	.14
CLSF-2ND	Freestanding Screens	.14
CLSF-2NN	Freestanding Screens	.14
CLSF-LND	Freestanding Screens	.13
CLSF-LNN	Freestanding Screens	.13
CLSF-LNS	Freestanding Screens	.13

Product Compatibility and Limited Warranty Policy

Great Expectations

You have them as a Haworth customer and so do we. And because we value our customers, we cover our products with the Haworth North America Product Compatibility and Limited Warranty Policy.

Our Commitment To Product Compatibility – Integrated Product Platforms

As a market leader in the design and manufacture of workspaces that adapt to change, we strive to maintain product compatibility within our various generations of integrated product platforms. This benefits the customer who desires to update or modify their work environment. It also benefits the customer needing to replace a product due to damage or other reasons but which is no longer manufactured or is otherwise unavailable, such as a fabric or finish that is discontinued because of changing market preferences. In both circumstances, we often can provide products with comparable function and performance.

Our Commitment To Product Quality – The Haworth North America Limited Warranty

To ensure customer satisfaction and peace of mind, we stand behind our products with the Haworth North America Limited Warranty. To review the current version of the limited warranty including its terms and conditions, please go to:

www.haworth.com/warranty or contact OneTouch@Haworth.com or 1 877 429 6784.

Warranty Requests or Questions

For questions or service requests pertaining to the Haworth Limited Warranty, please contact your Haworth dealer.

If you are unsure who your dealer is, please contact **OneTouch@Haworth.com or 1 877 429 6784.**

Effective: September 1, 2021

Terms of Sale

The Terms of Sale apply to all products in the North America Price Lists. To review the current version of the North American Terms of Sale, please go to:

www.haworth.com/terms-of-sale or contact OneTouch@Haworth.com or 1 877 429 6784.

Effective: September 2, 2022

HAWORTH

HAWORTH® is a registered trademark of Haworth, Inc.
© Haworth, Inc. All rights reserved. 2023 2.23 | Item #LIT21027
haworth.com | 800 344 2600